

**NATO STANDARD**

**AMedP-7.5**

**NATO PLANNING GUIDE FOR THE  
ESTIMATION OF CBRN CASUALTIES**

**EDITION A VERSION 1**

**OCTOBER 2017**



**NORTH ATLANTIC TREATY ORGANIZATION**

**ALLIED MEDICAL PUBLICATION**

Published by the  
NATO STANDARDIZATION OFFICE (NSO)  
© NATO/OTAN

**INTENTIONALLY BLANK**

**NORTH ATLANTIC TREATY ORGANIZATION (NATO)**

**NATO STANDARDIZATION OFFICE (NSO)**

**NATO LETTER OF PROMULGATION**

30 October 2017

1. The enclosed Allied Medical Publication AMedP-7.5, Edition A, Version 1, NATO PLANNING GUIDE FOR THE ESTIMATION OF CBRN CASUALTIES, which has been approved by the nations in the Military Committee Medical Standardization Board, is promulgated herewith. The agreement of nations to use this publication is recorded in STANAG 2553.
2. AMedP-7.5, Edition A, Version 1, effective upon receipt and supersedes AMedP-8(C), which shall be destroyed in accordance with the local procedure for the destruction of documents.
3. No part of this publication may be reproduced, stored in a retrieval system, used commercially, adapted, or transmitted in any form or by any means, electronic, mechanical, photo-copying, recording or otherwise, without the prior permission of the publisher. With the exception of commercial sales, this does not apply to member or partner nations, or NATO commands and bodies.
3. This publication shall be handled in accordance with C-M(2002)60.

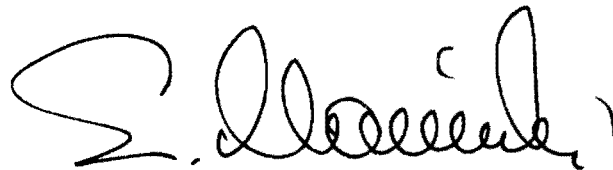

Edvardas MAŽEIKIS  
Major General, LTUAF  
Director, NATO Standardization Office

**INTENTIONALLY BLANK**

**RESERVED FOR NATIONAL LETTER OF PROMULGATION**

**INTENTIONALLY BLANK**



**INTENTIONALLY BLANK**



## **RECORD OF SPECIFIC RESERVATIONS**

[nation]	[detail of reservation]
GBR	The UK ratifies AMedP7.5 as guidance for medical capability planning, whilst reserving the right to use alternative toxicity assumptions and casualty calculation methods where appropriate.
<p>Note: The reservations listed on this page include only those that were recorded at time of promulgation and may not be complete. Refer to the NATO Standardization Document Database for the complete list of existing reservations.</p>	

**INTENTIONALLY BLANK**

<b>TABLE OF CONTENTS</b>
--------------------------

CHAPTER 1	DESCRIPTION OF THE METHODOLOGY .....	1-1
1.1.	INTRODUCTION AND DOCUMENT ORGANIZATION .....	1-1
1.2.	PURPOSE AND INTENDED USE .....	1-2
1.3.	SCOPE .....	1-3
1.3.1.	Challenge Types .....	1-4
1.3.2.	Types of Casualty .....	1-6
1.3.3.	Countermeasures .....	1-6
1.4.	DEFINITIONS .....	1-7
1.4.1.	Types of Casualty .....	1-10
1.5.	GENERAL ASSUMPTIONS, LIMITATIONS, AND CONSTRAINTS .....	1-12
1.6.	SUMMARY OF THE METHODOLOGY .....	1-13
1.6.1.	INPUT .....	1-13
1.6.2.	CHALLENGE .....	1-15
1.6.3.	RESPONSE and STATUS .....	1-15
1.6.4.	REPORT .....	1-18
1.6.5.	User Aids .....	1-19
CHAPTER 2	USER INPUT .....	2-1
2.1.	ICONS AND ICON ATTRIBUTES .....	2-1
2.1.1.	Overview of Icon Attributes .....	2-1
2.1.2.	CBRN Challenge or Effective CBRN Challenge .....	2-3
2.1.3.	Respiratory Minute Volume .....	2-6
2.1.4.	Body Surface Area .....	2-7
2.1.5.	Individual Protective Equipment (IPE) .....	2-7
2.1.6.	Vehicles and Shelters (Physical Protection and ColPro) .....	2-8
2.1.7.	Pre-Exposure Prophylaxis .....	2-11
2.1.8.	Uniform .....	2-11
2.1.9.	Aggregate Protection Factor .....	2-12
2.1.10.	Example Input and Comparison of Input Schemes .....	2-12
2.2.	METHODOLOGY PARAMETERS .....	2-15
CHAPTER 3	EFFECTIVE CBRN CHALLENGE ESTIMATION .....	3-1
3.1.	INPUT SCHEME 1 .....	3-1
3.2.	INPUT SCHEME 1 WITH TOXIC LOAD FOR CHEMICAL AGENTS .....	3-4
3.3.	INPUT SCHEME 2 .....	3-5
CHAPTER 4	CHEMICAL, RADIOLOGICAL, AND NUCLEAR HUMAN RESPONSE AND CASUALTY ESTIMATION .....	4-1
4.1.	CRN MODEL FRAMEWORK .....	4-1
4.1.1.	Human Response—Injury Profiles (CRN) .....	4-1
4.1.2.	Assignment of Personnel to Injury Profiles .....	4-4
4.1.3.	Casualty Estimation .....	4-8
4.2.	CHEMICAL AGENT MODELS .....	4-11
4.2.1.	Assumption and Constraint .....	4-11
4.2.2.	GA .....	4-11
4.2.3.	GB .....	4-14
4.2.4.	GD .....	4-16

4.2.5.	GF .....	4-19
4.2.6.	VX .....	4-22
4.2.7.	HD .....	4-26
4.2.8.	CG .....	4-33
4.2.9.	Cl <sub>2</sub> .....	4-36
4.2.10.	NH <sub>3</sub> .....	4-38
4.2.11.	AC .....	4-40
4.2.12.	CK .....	4-43
4.2.13.	H <sub>2</sub> S.....	4-45
4.3.	RADIOLOGICAL AGENT MODELS .....	4-48
4.3.1.	Assumptions and Limitation .....	4-48
4.3.2.	RDDs.....	4-48
4.3.3.	Fallout .....	4-54
4.3.4.	Threshold Lethal Dose and Time to Death.....	4-57
4.3.5.	Dose Ranges, Injury Profiles, and Medical Treatment Outcomes ....	4-58
4.4.	NUCLEAR EFFECTS MODELS.....	4-60
4.4.1.	Assumptions and Limitations.....	4-60
4.4.2.	Initial Whole-Body Radiation .....	4-60
4.4.3.	Blast .....	4-63
4.4.4.	Thermal Fluence .....	4-66
CHAPTER 5 BIOLOGICAL HUMAN RESPONSE AND CASUALTY ESTIMATION .....		5-1
5.1.	BIOLOGICAL AGENT MODEL FRAMEWORK.....	5-1
5.1.1.	Human Response Submodels.....	5-1
5.1.2.	Casualty Estimation.....	5-3
5.1.3.	Assumptions and Limitations.....	5-3
5.1.4.	Non-Contagious Casualty Estimation.....	5-3
5.1.5.	Contagious Casualty Estimation .....	5-9
5.1.6.	Equations Needed to Execute Casualty Estimates .....	5-17
5.2.	BIOLOGICAL AGENT MODELS .....	5-18
5.2.1.	Anthrax.....	5-18
5.2.2.	Brucellosis.....	5-33
5.2.3.	Glanders.....	5-43
5.2.4.	Melioidosis .....	5-50
5.2.5.	Plague (isolation/quarantine model) .....	5-55
5.2.6.	Plague (contagious model).....	5-59
5.2.7.	Q Fever .....	5-60
5.2.8.	Tularemia .....	5-64
5.2.9.	Smallpox (isolation/quarantine model) .....	5-69
5.2.10.	Smallpox (contagious model).....	5-73
5.2.11.	Eastern Equine Encephalitis Virus (EEEV) Disease .....	5-75
5.2.12.	Venezuelan Equine Encephalitis Virus (VEEV) Disease .....	5-76
5.2.13.	Western Equine Encephalitis Virus (WEEV) Disease.....	5-79
5.2.14.	Botulism .....	5-81
5.2.15.	Ricin Intoxication .....	5-90
5.2.16.	Staphylococcal Enterotoxin B (SEB) Intoxication .....	5-93

5.2.17.	T-2 Mycotoxicosis.....	5-96
5.2.18.	Ebola Virus Disease .....	5-98
CHAPTER 6 CASUALTY SUMMATION AND REPORTING .....		6-1
6.1.	APPLICATION OF AJP-4.10 REQUIREMENTS .....	6-1
6.2.	DESCRIPTION OF OUTPUT REPORTING.....	6-2
6.3.	PERSONNEL STATUS TABLE FOR NUCLEAR CASUALTIES.....	6-6
ANNEX A ILLUSTRATIVE EXAMPLES .....		A-1
A.1.	OVERVIEW .....	A-1
A.2.	INPUT (ALL ILLUSTRATIVE EXAMPLES) .....	A-1
A.2.1.	Icons and Icon Attributes.....	A-2
A.2.2.	Methodology Parameters .....	A-15
A.3.	CHEMICAL AGENT: GB .....	A-15
A.3.1.	INPUT .....	A-16
A.3.2.	CHALLENGE .....	A-18
A.3.3.	RESPONSE/STATUS .....	A-20
A.3.4.	REPORT .....	A-23
A.4.	CHEMICAL AGENT: CK .....	A-25
A.4.1.	INPUT .....	A-27
A.4.2.	CHALLENGE .....	A-28
A.4.3.	RESPONSE/STATUS .....	A-29
A.4.4.	REPORT .....	A-33
A.5.	RDD: <sup>137</sup> CS.....	A-35
A.5.1.	INPUT .....	A-37
A.5.2.	CHALLENGE .....	A-38
A.5.3.	RESPONSE/STATUS .....	A-40
A.5.4.	REPORT .....	A-41
A.6.	NUCLEAR DETONATION: 10 KT GROUND BURST .....	A-43
A.6.1.	INPUT .....	A-46
A.6.2.	CHALLENGE .....	A-47
A.6.3.	RESPONSE/STATUS .....	A-52
A.6.4.	REPORT .....	A-58
A.7.	NON-CONTAGIOUS BIOLOGICAL AGENT: <i>B. ANTHRACIS</i> .....	A-60
A.7.1.	INPUT .....	A-60
A.7.2.	CHALLENGE .....	A-62
A.7.3.	RESPONSE/STATUS .....	A-63
A.7.4.	REPORT .....	A-65
A.8.	CONTAGIOUS BIOLOGICAL AGENT: <i>V. MAJOR</i> .....	A-69
A.8.1.	INPUT .....	A-70
A.8.2.	CHALLENGE .....	A-71
A.8.3.	RESPONSE/STATUS—Isolation/Quarantine Model .....	A-71
A.8.4.	REPORT—Isolation/Quarantine Model.....	A-73
A.8.5.	RESPONSE/STATUS—Contagious Model.....	A-77
A.8.6.	REPORT—Contagious Model.....	A-79
ANNEX B REFERENCES .....		B-1

<b>LIST OF FIGURES</b>
------------------------

Figure 1-1:	Relationship of Casualty Criterion, Injury Severity Level, and WIA ..	1-16
Figure 1-2:	Decision Tree for Assignment of Casualty Category .....	1-17
Figure 1-3:	AMedP-7.5 Methodology Overview .....	1-20
Figure 4-1:	Flowchart for Generation of Composite Injury Profiles .....	4-2
Figure 4-2:	Notional Example of Composite Injury Profile Generation.....	4-2
Figure 4-3:	Human Response Casualty Estimation Flowchart for GA .....	4-13
Figure 4-4:	Human Response Casualty Estimation Flowchart for GB .....	4-16
Figure 4-5:	Human Response Casualty Estimation Flowchart for GD.....	4-19
Figure 4-6:	Human Response Casualty Estimation Flowchart for GF .....	4-22
Figure 4-7:	Human Response and Casualty Estimation Flowchart for VX.....	4-25
Figure 4-8:	Human Response and Casualty Estimation Flowchart for HD .....	4-32
Figure 4-9:	Human Response and Casualty Estimation Flowchart for CG .....	4-35
Figure 4-10:	Human Response and Casualty Estimation Flowchart for Cl <sub>2</sub> .....	4-37
Figure 4-11:	Human Response and Casualty Estimation Flowchart for NH <sub>3</sub> .....	4-39
Figure 4-12:	Human Response and Casualty Estimation Flowchart for AC .....	4-42
Figure 4-13:	Human Response and Casualty Estimation Flowchart for CK .....	4-45
Figure 4-14:	Human Response and Casualty Estimation Flowchart for H <sub>2</sub> S .....	4-47
Figure 4-15:	Human Response and Casualty Estimation Flowchart for RDDs.....	4-53
Figure 4-16:	Human Response and Casualty Estimation Flowchart for Fallout....	4-56
Figure 4-17:	Human Response and Casualty Estimation Flowchart for Initial Whole- Body Radiation From a Nuclear Detonation .....	4-62
Figure 4-18:	Human Response and Casualty Estimation Flowchart for Primary Nuclear Blast.....	4-65
Figure 4-19:	Human Response and Casualty Estimation Flowchart for Thermal Fluence From a Nuclear Detonation.....	4-70
Figure 5-1:	Non-Contagious Agent/Disease Casualty Estimation Flowchart .....	5-4
Figure 5-2:	Interaction of SEIRP Cohorts and Parameters .....	5-13
Figure 5-3:	Human Response and Casualty Estimation for Anthrax.....	5-33
Figure 5-4:	Human Response and Casualty Estimation for Brucellosis.....	5-43
Figure 5-5:	Human Response and Casualty Estimation for Glanders .....	5-49
Figure 5-6:	Human Response and Casualty Estimation for Melioidosis .....	5-55
Figure 5-7:	Human Response and Casualty Estimation for Plague (isolation/quarantine model) .....	5-59
Figure 5-8:	Human Response and Casualty Estimation for Q Fever .....	5-64
Figure 5-9:	Human Response and Casualty Estimation for Tularemia .....	5-69
Figure 5-10:	Human Response and Casualty Estimation Flowchart for Smallpox (isolation/quarantine model) .....	5-73
Figure 5-11:	Human Response and Casualty Estimation Flowchart for EEEV Disease .....	5-76
Figure 5-12:	Human Response and Casualty Estimation Flowchart for VEEV Disease .....	5-79
Figure 5-13:	Human Response and Casualty Estimation Flowchart for WEEV Disease .....	5-81
Figure 5-14:	Human Response and Casualty Estimation Flowchart for Botulism.	5-89

Figure 5-15: Human Response and Casualty Estimation Flowchart for Ricin Intoxication .....	5-93
Figure 5-16: Human Response and Casualty Estimation Flowchart for SEB Intoxication .....	5-95
Figure 5-17: Human Response and Casualty Estimation Flowchart for T-2 Mycotoxicosis .....	5-98
Figure A-1: Layout of Icons .....	A-2
Figure A-2: GB Attack on Task Force .....	A-17
Figure A-3: CK Attack on Task Force .....	A-28
Figure A-4: <sup>137</sup> Cs RDD Attack on Task Force .....	A-38
Figure A-5: 10 kT Ground Nuclear Attack on Task Force .....	A-47
Figure A-6: <i>B. anthracis</i> (Anthrax) Attack on Task Force .....	A-62
Figure A-7: <i>V. major</i> (Smallpox) Attack on Task Force .....	A-71

<b>LIST OF TABLES</b>
-----------------------

Table 1-1:	Chemical Agent Challenge Types .....	1-4
Table 1-2:	Challenge Types and Associated Terminology .....	1-8
Table 1-3:	Injury Severity Level Definitions .....	1-10
Table 1-4:	Casualty Reporting Rules.....	1-19
Table 1-5:	User's Roadmap .....	1-21
Table 1-6:	Cross-References for AMedP-7.5 and Its Technical Reference Manual .....	1-22
Table 1-7:	Guide to AMedP-7.5 Measurement Units.....	1-26
Table 2-1:	Challenge-Modifying Icon Attributes.....	2-2
Table 2-2:	Challenge Types and Associated Units for CBRN Challenges.....	2-4
Table 2-3:	Suggested and Default Respiratory Minute Volume.....	2-7
Table 2-4:	Suggested IPE Protection Factors .....	2-8
Table 2-5:	Suggested Air Exchange Rates for Vehicles and Shelters Without ColPro .....	2-9
Table 2-6:	Suggested Inhalation and Percutaneous Protection Factors for Vehicles and Shelters .....	2-10
Table 2-7:	Suggested Radiation Shielding Protection Factors for Vehicles and Shelters .....	2-10
Table 2-8:	Suggested Blast Shielding Protection Factors .....	2-11
Table 2-9:	Suggested Protection Factors for CRN Prophylaxis.....	2-11
Table 2-10:	Example Definition of Icons.....	2-12
Table 2-11:	Example Input for Input Scheme 1, for a Notional GB Incident .....	2-13
Table 2-12:	Example Input for Input Scheme 2, for a Notional GB Incident .....	2-14
Table 2-13:	Example Differences in Effective CBRN Challenge Resulting from Using Different Input Schemes for the Same Notional GB Incident.....	2-15
Table 2-14:	Default Values for Methodology Parameters.....	2-16
Table 3-1:	Suggested Dose Conversion Factors for RDDs for Selected Isotopes (Daughter Products Included)* .....	3-3
Table 3-2:	Suggested Conversion Factors for Fallout .....	3-4
Table 4-1:	Inhaled GA Toxicity Parameters and Symptoms .....	4-12
Table 4-2:	Inhaled GA Injury Profiles.....	4-12
Table 4-3:	GA Medical Treatment Outcome Reporting .....	4-12
Table 4-4:	Inhaled GB Toxicity Parameters and Symptoms .....	4-14
Table 4-5:	Inhaled GB Injury Profiles.....	4-15
Table 4-6:	GB Medical Treatment Outcome Reporting .....	4-15
Table 4-7:	Inhaled GD Toxicity Parameters and Symptoms.....	4-17
Table 4-8:	Inhaled GD Injury Profiles .....	4-17
Table 4-9:	GD Medical Treatment Outcome Reporting .....	4-18
Table 4-10:	Inhaled GF Toxicity Parameters and Symptoms .....	4-20
Table 4-11:	Inhaled GF Injury Profiles.....	4-20
Table 4-12:	GF Medical Treatment Outcome Reporting.....	4-21
Table 4-13:	Inhaled* VX Toxicity Parameters and Symptoms .....	4-23
Table 4-14:	Inhaled* VX Injury Profiles .....	4-23
Table 4-15:	Percutaneous VX Liquid Toxicity Parameters and Symptoms .....	4-24



Table 4-16:	Percutaneous VX Liquid Injury Profiles .....	4-24
Table 4-17:	VX Medical Treatment Outcome Reporting.....	4-24
Table 4-18:	Recommended Parameter Values for Equivalent Vapour Conversion Factors for HD ( $CF_{HD,k}$ ) .....	4-27
Table 4-19:	Inhaled HD Toxicity Parameters and Symptoms .....	4-28
Table 4-20:	Inhaled HD Injury Profiles.....	4-28
Table 4-21:	Ocular HD Vapour Toxicity Parameters and Symptoms.....	4-29
Table 4-22:	Ocular HD Vapour Injury Profiles .....	4-29
Table 4-23:	Equivalent Percutaneous HD Vapour Toxicity Parameters and Symptoms .....	4-30
Table 4-24:	Equivalent Percutaneous HD Vapour Injury Profiles .....	4-30
Table 4-25:	HD Medical Treatment Outcome Reporting .....	4-31
Table 4-26:	Inhaled CG Toxicity Parameters and Symptoms.....	4-33
Table 4-27:	Inhaled CG Injury Profiles .....	4-33
Table 4-28:	Peak CG Concentration Ranges .....	4-33
Table 4-29:	Peak CG Concentration Injury Profile.....	4-34
Table 4-30:	CG Medical Treatment Outcome Reporting .....	4-34
Table 4-31:	Inhaled Cl <sub>2</sub> Toxicity Parameters and Symptoms .....	4-36
Table 4-32:	Inhaled Cl <sub>2</sub> Injury Profiles .....	4-36
Table 4-33:	Cl <sub>2</sub> Medical Treatment Outcome Reporting.....	4-37
Table 4-34:	Inhaled NH <sub>3</sub> Toxicity Parameters and Symptoms.....	4-38
Table 4-35:	Inhaled NH <sub>3</sub> Injury Profiles .....	4-38
Table 4-36:	NH <sub>3</sub> Medical Treatment Outcome Reporting .....	4-39
Table 4-37:	Inhaled AC Toxicity Parameters and Symptoms .....	4-40
Table 4-38:	Inhaled AC Injury Profiles.....	4-41
Table 4-39:	AC Medical Treatment Outcome Reporting.....	4-41
Table 4-40:	Inhaled CK Toxicity Parameters and Symptoms .....	4-43
Table 4-41:	Inhaled CK Injury Profiles.....	4-44
Table 4-42:	Peak CK Concentration Ranges .....	4-44
Table 4-43:	Peak CK Concentration Injury Profiles .....	4-44
Table 4-44:	CK Medical Treatment Outcome Reporting.....	4-44
Table 4-45:	Inhaled H <sub>2</sub> S Toxicity Parameters and Symptoms.....	4-46
Table 4-46:	Inhaled H <sub>2</sub> S Injury Profiles .....	4-46
Table 4-47:	H <sub>2</sub> S Medical Treatment Outcome Reporting .....	4-46
Table 4-48:	Whole-Body Radiation LD <sub>50</sub> for Instantaneous Challenges .....	4-57
Table 4-49:	Cutaneous Radiation Dose Ranges .....	4-58
Table 4-50:	Cutaneous Radiation Injury Profiles .....	4-58
Table 4-51:	Cutaneous Radiation Medical Treatment Outcome Reporting .....	4-58
Table 4-52:	Whole-Body Radiation Dose Ranges .....	4-59
Table 4-53:	Whole-Body Radiation Injury Profiles.....	4-59
Table 4-54:	Whole-Body Radiation Medical Treatment Outcome Reporting .....	4-59
Table 4-55:	Primary Nuclear Blast Insult Ranges.....	4-64
Table 4-56:	Primary Nuclear Blast Injury Profiles.....	4-64
Table 4-57:	Primary Nuclear Blast Medical Treatment Outcome Reporting .....	4-64
Table 4-58:	Recommended Thermal Transmission Probabilities for Various Vehicle and Shelter Types .....	4-67

Table 4-59:	Thermal Fluence Threshold Values for Partial-Thickness (Second Degree) Burns for Various Uniform Types .....	4-68
Table 4-60:	Thermal Fluence Insult Ranges .....	4-69
Table 4-61:	Thermal Fluence Injury Profiles.....	4-69
Table 4-62:	Thermal Fluence Medical Treatment Outcome Reporting.....	4-69
Table 5-1:	Example PDT, “Daily Fraction of Non-Survivors (F) Ill with Example Disease Who DOW” .....	5-7
Table 5-2:	Factors to Consider for User-Specified Parameters .....	5-12
Table 5-3:	Guidance on Using SEIRP Equations to Populate Output Tables....	5-15
Table 5-4:	Anthrax Dose Ranges .....	5-19
Table 5-5:	Probability of an Individual Still Being in Stage 1 of Anthrax ( $P_{in-Stage1}$ ) After Specified Durations Spent in Stage 1 .....	5-21
Table 5-6:	Anthrax Injury Profile .....	5-21
Table 5-7:	Anthrax Prophylaxis Summary .....	5-21
Table 5-8:	Anthrax Submodel Summary .....	5-22
Table 5-9:	Daily Fraction of Individuals Ill with Anthrax ( $E_{DR}$ ) Who Become WIA, for Casualty Criterion WIA(1+) or WIA(2+)* .....	5-23
Table 5-10:	Daily Fraction of Individuals Ill with Anthrax ( $E_{DR}$ ) Who Become WIA, for Casualty Criterion WIA(3+)* .....	5-24
Table 5-11:	Daily Fraction of Untreated Anthrax Non-Survivors ( $F_{DR,U}$ ) Who DOW	5-25
Table 5-12:	Daily Fraction of Stage 1 Treated Anthrax Non-Survivors ( $F_{DR,T-1}$ ) and Survivors ( $S_{DR,T-1}$ ) Who Enter Stage 2.....	5-26
Table 5-13:	Daily Fraction of Stage 1 Treated Anthrax Non-Survivors ( $F_{DR,T-1}$ ) Who DOW* .....	5-27
Table 5-14:	Daily Fraction of Stage 1 Treated Anthrax Survivors ( $S_{DR,T-1}$ ) Who Become CONV* .....	5-29
Table 5-15:	Daily Fraction of Stage 1 Treated Anthrax Survivors ( $S_{DR,T-1}$ ) Who Become RTD.....	5-30
Table 5-16:	Daily Fraction of Stage 2 Treated Anthrax Non-Survivors ( $F_{DR,T-2}$ ) Who DOW .....	5-31
Table 5-17:	Brucellosis Injury Profile .....	5-36
Table 5-18:	Brucellosis Submodel Summary .....	5-36
Table 5-19:	Daily Fraction of Individuals Ill with Insidious Onset Brucellosis ( $S_{ins,U}$ , $S_{ins,T-WIA}$ , $S_{ins,T-1}$ , $S_{ins,T-2}$ ) Who Become WIA, for Casualty Criterion WIA(1+); Daily Fraction of Individuals Ill with Abrupt Onset Brucellosis ( $S_{abr,U}$ , $S_{abr,T-WIA}$ , $S_{abr,T}$ ) Who Become WIA, for any Casualty Criterion*	5-37
Table 5-20:	Daily Fraction of Individuals Ill with Insidious Onset Brucellosis ( $S_{ins,U}$ , $S_{ins,T-WIA}$ , $S_{ins,T-2}$ ) Who Become WIA, for Casualty Criterion WIA(2+) or WIA(3+)* .....	5-37
Table 5-21:	Daily Fraction of Untreated Insidious Onset Brucellosis Survivors ( $S_{ins,U}$ ) or Abrupt Onset Brucellosis Survivors ( $S_{abr,U}$ ) Who Become RTD* ..	5-38
Table 5-22:	Daily Fraction of Abrupt Onset Brucellosis Casualties Treated Upon Becoming WIA ( $S_{abr,T-WIA}$ ) Who Become CONV*; Daily Fraction of Insidious Onset Brucellosis Casualties Treated Upon Becoming WIA	

	( $S_{ins,T-WIA}$ ) Who Become CONV, for Casualty Criterion WIA(1+)* .....	5-39
Table 5-23:	Daily Fraction of Insidious Onset Brucellosis Casualties Treated Upon Becoming WIA ( $S_{ins,T-WIA}$ ) Who Become CONV, for Casualty Criterion WIA(2+) or WIA(3+)* .....	5-39
Table 5-24:	Daily Fraction of Abrupt Onset Brucellosis Casualties Treated Upon Becoming WIA ( $S_{abr,T-WIA}$ ) Who Become RTD*; Daily Fraction of Insidious Onset Brucellosis Casualties Treated Upon Becoming WIA ( $S_{ins,T-WIA}$ ) Who Become RTD, for Casualty Criterion WIA(1+)* .....	5-40
Table 5-25:	Daily Fraction of Insidious Onset Brucellosis Casualties Treated Upon Becoming WIA ( $S_{ins,T-WIA}$ ) Who Become RTD, for Casualty Criterion WIA(2+) or WIA(3+)* .....	5-41
Table 5-26:	Daily Fraction of Stage 1 Treated Brucellosis Survivors ( $S_{abr,T}$ , $S_{ins,T-1}$ ) and Stage 2 Treated Brucellosis Survivors ( $S_{ins,T-2}$ ) Who Become CONV .....	5-42
Table 5-27:	Daily Fraction of Stage 1 Treated Brucellosis Survivors ( $S_{abr,T}$ , $S_{ins,T-1}$ ) and Stage 2 Treated Brucellosis Survivors ( $S_{ins,T-2}$ ) Who Become RTD-42	
Table 5-28:	Glanders Injury Profile .....	5-44
Table 5-29:	Glanders Submodel Summary .....	5-44
Table 5-30:	Daily Fraction of Individuals Ill with Glanders (E) Who Become WIA, for Casualty Criterion WIA(1+)* .....	5-45
Table 5-31:	Daily Fraction of Individuals Ill with Glanders (E) Who Become WIA, for Casualty Criterion WIA(2+)* .....	5-45
Table 5-32:	Daily Fraction of Individuals Ill with Glanders (E) Who Become WIA, for Casualty Criterion WIA(3+)* .....	5-46
Table 5-33:	Daily Fraction of Untreated Glanders Non-Survivors ( $F_U$ ) Who DOW ..	5-46
Table 5-34:	Daily Fraction of Stage 1 Treated Glanders Survivors ( $S_{T-1}$ ) Who Enter Stage 2 .....	5-47
Table 5-35:	Daily Fraction of Stage 1 Treated Glanders Survivors ( $S_{T-1}$ ) Who Enter Stage 3 .....	5-47
Table 5-36:	Daily Fraction of Stage 1 Treated Glanders Survivors ( $S_{T-1}$ ) Who Become RTD .....	5-47
Table 5-37:	Daily Fraction of Stage 2 Treated Glanders Survivors ( $S_{T-2}$ ) Who Enter Stage 3 .....	5-47
Table 5-38:	Daily Fraction of Stage 2 Treated Glanders Survivors ( $S_{T-2}$ ) Who Become RTD .....	5-48
Table 5-39:	Daily Fraction of Stage 3 Treated Glanders Survivors ( $S_{T-3}$ ) Who Become RTD .....	5-48
Table 5-40:	Melioidosis Injury Profile .....	5-52
Table 5-41:	Melioidosis Submodel Summary .....	5-52
Table 5-42:	Daily Fraction of Individuals Ill with Melioidosis (E) Who Become WIA* 5-53	
Table 5-43:	Daily Fraction of Individuals Ill with Melioidosis (E*) Who Enter Stage 2 of Illness <sup>†</sup> .....	5-53
Table 5-44:	Daily Fraction of Untreated or Treated Melioidosis Non-Survivors ( $F_U$ , $F_T$ -	

	$W_{IA}$ , $F_{T-1}$ , or $F_{T-2}$ ) Who DOW .....	5-53
Table 5-45:	Daily Fraction of Untreated Melioidosis Survivors ( $S_U$ ) Who Become RTD .....	5-53
Table 5-46:	Daily Fraction of Melioidosis Survivors Treated Upon Becoming $W_{IA}$ ( $S_{T-WIA}$ ) Who Become RTD* .....	5-54
Table 5-47:	Daily Fraction of Stage 1 Treated Melioidosis Survivors ( $S_{T-1}$ ) and Stage 2 Treated Melioidosis Survivors ( $S_{T-2}$ ) Who Become RTD .....	5-54
Table 5-48:	Plague Injury Profile .....	5-57
Table 5-49:	Plague Prophylaxis Summary .....	5-57
Table 5-50:	Plague Submodel Summary .....	5-57
Table 5-51:	Daily Fraction of Individuals Ill with Plague (E) Who Become $W_{IA}$ , for Casualty Criterion $W_{IA}(1^+)$ or $W_{IA}(2^+)$ .....	5-58
Table 5-52:	Daily Fraction of Individuals Ill with Plague (E) Who Become $W_{IA}$ , for Casualty Criterion $W_{IA}(3^+)$ .....	5-58
Table 5-53:	Daily Fraction of Untreated or Treated Plague Non-Survivors ( $F_U$ , $F_{T-2}$ , or F) Who DOW .....	5-58
Table 5-54:	Daily Fraction of Plague Survivors Treated Upon Becoming $W_{IA}$ ( $S_{T-WIA}$ ) Who Become RTD* .....	5-58
Table 5-55:	Daily Fraction of Stage 1 Treated Plague Survivors ( $S_{T-1}$ ) Who Become RTD .....	5-59
Table 5-56:	SEIRP Model Parameter Values for Plague .....	5-60
Table 5-57:	$\beta(d)$ Values for Plague .....	5-60
Table 5-58:	Q Fever Dose Ranges .....	5-61
Table 5-59:	Q Fever Injury Profile .....	5-62
Table 5-60:	Q Fever Prophylaxis Summary .....	5-62
Table 5-61:	Q Fever Submodel Summary .....	5-62
Table 5-62:	Dose-Dependent Day on Which Individuals Ill with Q Fever ( $E_{DR}$ ) Become $W_{IA}$ , for Casualty Criterion $W_{IA}(1^+)$ or $W_{IA}(2^+)$ .....	5-63
Table 5-63:	Daily Fraction of Untreated Q Fever Survivors in Dose Range DR ( $S_{DR,U}$ ) who Become RTD* .....	5-63
Table 5-64:	Dose-Dependent Day on Which Q Fever Survivors Treated Upon Becoming $W_{IA}$ ( $S_{DR,T-WIA}$ ) Become RTD .....	5-63
Table 5-65:	Daily Fraction of Stage 1 Treated Q Fever Survivors ( $S_{DR,T}$ ) Who Become RTD .....	5-64
Table 5-66:	Tularemia Dose Ranges .....	5-65
Table 5-67:	Tularemia Injury Profile .....	5-66
Table 5-68:	Tularemia Prophylaxis Summary .....	5-67
Table 5-69:	Tularemia Submodel Summary .....	5-67
Table 5-70:	Dose-Dependent Day on Which Individuals Ill with Tularemia ( $E_{DR}$ ) Become $W_{IA}$ , for Any Casualty Criterion* .....	5-68
Table 5-71:	Dose-Dependent Day on Which Tularemia Non-Survivors ( $F_{DR,U}$ ) Enter Stage 2 of Illness .....	5-68
Table 5-72:	Dose-Dependent Day on Which Untreated Tularemia Non-Survivors ( $F_{DR,U}$ ) DOW .....	5-68
Table 5-73:	Dose-Dependent Day on Which Tularemia Survivors ( $S_{DR,U}$ , $S_{DR,T-3}$ ) Enter Stage 3 of Illness .....	5-68

Table 5-74:	Dose-Dependent Day on Which Untreated Tularemia Survivors ( $S_{DR,U}$ ) Become RTD.....	5-68
Table 5-75:	Dose-Dependent Day on Which Tularemia Survivors Treated Upon Becoming WIA ( $S_{DR,T-WIA}$ ) Become RTD*.....	5-68
Table 5-76:	Daily Fraction of Stage 1, 2, or 3 Treated Tularemia Survivors ( $S_{DR,T-1}$ , $S_{DR,T-2}$ , $S_{DR,T-3}$ ) Who Become RTD .....	5-68
Table 5-77:	Smallpox Injury Profile.....	5-71
Table 5-78:	Smallpox Prophylaxis Summary.....	5-71
Table 5-79:	Smallpox Submodel Summary .....	5-71
Table 5-80:	Daily Fraction of Individuals Ill with Smallpox ( $E_U$ and $E_V$ ) Who Become WIA, for Casualty Criterion WIA(1 <sup>+</sup> ) or WIA(2 <sup>+</sup> )* .....	5-72
Table 5-81:	Daily Fraction of Individuals Ill with Smallpox ( $E_U$ and $E_V$ ) Who Become WIA, for Casualty Criterion WIA(3 <sup>+</sup> )* .....	5-72
Table 5-82:	Daily Fraction of Smallpox Non-Survivors ( $F_U$ and $F_V$ ) Who DOW and Smallpox Survivors Who Become CONV .....	5-72
Table 5-83:	Daily Fraction of Smallpox Survivors ( $S_U$ and $S_V$ ) Who Become RTD..	5-72
Table 5-84:	SEIRP Model Parameter Values for Smallpox .....	5-74
Table 5-85:	$\beta(d)$ Values for Smallpox .....	5-74
Table 5-86:	$\rho(d)$ Values SEIRP Model for Smallpox.....	5-74
Table 5-87:	EEEV Disease Injury Profile.....	5-75
Table 5-88:	EEEV Disease Submodel Summary .....	5-75
Table 5-89:	Daily Fraction of Individuals Ill with EEEV Disease (E) Who Become WIA, for Casualty Criterion WIA(1 <sup>+</sup> ) or WIA(2 <sup>+</sup> )* .....	5-76
Table 5-90:	Daily Fraction of EEEV Disease Survivors (S) Who Become RTD ..	5-76
Table 5-91:	VEEV Disease Injury Profile.....	5-77
Table 5-92:	VEEV Disease Submodel Summary .....	5-77
Table 5-93:	Daily Fraction of Individuals Ill with VEEV Disease (E) Who Become WIA, for Any Casualty Criterion* .....	5-78
Table 5-94:	Daily Fraction of VEEV Disease Survivors (S) Who Enter Stage 2 of Illness .....	5-78
Table 5-95:	Daily Fraction of VEEV Disease Survivors (S) Who Enter Stage 3 of Illness .....	5-78
Table 5-96:	Daily Fraction of VEEV Disease Survivors (S) Who Become RTD ..	5-78
Table 5-97:	WEEV Disease Injury Profile.....	5-80
Table 5-98:	WEEV Disease Submodel Summary .....	5-80
Table 5-99:	Daily Fraction of Individuals Ill with WEEV Disease (E) Who Become WIA, for Casualty Criterion WIA(1 <sup>+</sup> ) or WIA(2 <sup>+</sup> )* .....	5-80
Table 5-100:	Daily Fraction of WEEV Disease Survivors (S) Who Become RTD..	5-81
Table 5-101:	Probability That an Individual in the $E_{leth}$ Cohort is DOW On $d_{trt-bot}$ ( $P_{DOW}$ ) .....	5-83
Table 5-102:	Probability That an Individual in the $E_{leth}$ Cohort is in Stage 3 of Botulism On $d_{trt-bot}$ ( $P_{in-Stg3}$ ).....	5-84
Table 5-103:	Probability That an Individual in the $E_{leth}$ Cohort is in Stage 2 of Botulism On $d_{trt-bot}$ ( $P_{in-Stg2}$ ).....	5-84
Table 5-104:	Botulism Injury Profile.....	5-84

Table 5-105: Botulism Prophylaxis Summary.....	5-84
Table 5-106: Botulism Submodel Summary .....	5-85
Table 5-107: Daily Fraction of Individuals Ill with Botulism (E) Who Become WIA, for Casualty Criterion WIA(1+) or WIA(2+).....	5-86
Table 5-108: Daily Fraction of Untreated Non-Survivors ( $F_U$ ), Treated Ventilated Non-Survivors ( $F_{vent}$ ), Treated Ventilated Survivors ( $S_{vent}$ ), and Stage 2 Treated Unventilated Survivors ( $S_{unvent-2}$ ) Ill with Botulism Who Become WIA, for Casualty Criterion WIA(3+) .....	5-86
Table 5-109: Daily Fraction of Untreated Survivors ( $S_U$ ) and Treated Sub-lethal Dose Survivors ( $S_{eff}$ ) Ill with Botulism Who Become WIA, for Casualty Criterion WIA(3+).....	5-86
Table 5-110: Daily Fraction of Untreated Botulism Non-Survivors ( $F_U$ ) Who DOW.....	5-86
Table 5-111: Daily Fraction of Untreated Botulism Survivors ( $S_U$ ) Who Enter Stage 3 of Illness .....	5-86
Table 5-112: Daily Fraction of Untreated Botulism Survivors ( $S_U$ ) Who Become RTD .....	5-87
Table 5-113: Daily Fraction of Treated Ventilated Botulism Non-Survivors ( $F_{vent}$ ) Who DOW; Daily Fraction of Treated Ventilated Botulism Survivors ( $S_{vent}$ ) Who Become CONV.....	5-87
Table 5-114: Daily Fraction of Treated Sub-lethal Dose Botulism Survivors ( $S_{eff}$ ) Who Become CONV.....	5-87
Table 5-115: Daily Fraction of Treated Sub-lethal Dose Botulism Survivors ( $S_{eff}$ ) Who Become RTD.....	5-87
Table 5-116: Daily Fraction of Stage 1 Treated Unventilated Botulism Survivors ( $S_{unvent-1}$ ) Who Become CONV .....	5-87
Table 5-117: Daily Fraction of Stage 1 Treated Unventilated Botulism Survivors ( $S_{unvent-1}$ ) Who Become RTD .....	5-88
Table 5-118: Daily Fraction of Stage 2 Treated Unventilated Botulism Survivors ( $S_{unvent-2}$ ) Who Become CONV .....	5-88
Table 5-119: Daily Fraction of Stage 2 Treated Unventilated Botulism Survivors ( $S_{unvent-2}$ ) Who Become RTD .....	5-88
Table 5-120: Ricin Intoxication Dose Ranges for the $F_{DR}$ Sub-Cohorts.....	5-90
Table 5-121: Ricin Intoxication Injury Profile .....	5-91
Table 5-122: Ricin Intoxication Submodel Summary.....	5-91
Table 5-123: Daily Fraction of Individuals Ill with Ricin Intoxication (E) Who Become WIA, for WIA(1+).....	5-92
Table 5-124: Dose-Dependent Day on Which Ricin Intoxication Non-Survivors ( $F_{Stg2-X}$ ) Become WIA, for WIA(2+) or WIA(3+) .....	5-92
Table 5-125: Dose-Dependent Day on Which Ricin Intoxication Non-Survivors ( $F_{Stg3-X}$ ) Enter Stage 3 of Illness .....	5-92
Table 5-126: Dose-Dependent Day on Which Ricin Intoxication Non-Survivors ( $F_{DR}$ ) DOW .....	5-92
Table 5-127: Daily Fraction of Ricin Intoxication Survivors (S) Who Become RTD.....	5-92
Table 5-128: SEB Intoxication Dose Ranges for the $S_{DR}$ Sub-Cohorts .....	5-94
Table 5-129: SEB Intoxication Injury Profile .....	5-94
Table 5-130: SEB Intoxication Submodel Summary.....	5-94

Table 5-131: Daily Fraction of Individuals Ill with SEB Intoxication (E) Who Become WIA, for Any Casualty Criterion.....	5-95
Table 5-132: Daily Fraction of SEB Intoxication Non-Survivors (F) who DOW.....	5-95
Table 5-133: Daily Fraction of SEB Intoxication Survivors (S <sub>DR</sub> ) Who Become CONV .....	5-95
Table 5-134: Daily Fraction of SEB Intoxication Survivors (S <sub>DR</sub> ) Who Become RTD 5-95	
Table 5-135: T-2 Mycotoxicosis Injury Profile.....	5-96
Table 5-136: T-2 Mycotoxicosis Submodel Summary .....	5-97
Table 5-137: Daily Fraction of Individuals Ill with T-2 Mycotoxicosis (E) Who Become WIA, for WIA(1+) or WIA(2+)* .....	5-97
Table 5-138: Daily Fraction of Individuals Ill with T-2 Mycotoxicosis (E) Who Become WIA, for WIA(3+)* .....	5-97
Table 5-139: Daily Fraction of T-2 Mycotoxicosis Non-Survivors (F) Who DOW* ..	5-97
Table 5-140: Daily Fraction of T-2 Mycotoxicosis Survivors (S) Who Become RTD . 5-97	
Table 5-141: Approximate EVD Parameter Values .....	5-98
Table 6-1: Compartments for Reporting Casualty Profile .....	6-2
Table 6-2: Casualty Category Reporting Rules for Multiple Injury Profiles .....	6-3
Table 6-3: Estimated Daily Number of New (Challenge) Casualties* .....	6-4
Table 6-4: Estimated Personnel Status for (Challenge) Casualties* .....	6-5
Table 6-5: Estimated Personnel Status for Nuclear Casualties* .....	6-7
Table A-1: User Input for Illustrative Examples Tactical Scenario .....	A-5
Table A-2: Values of Methodology Parameters for Illustrative Examples .....	A-15
Table A-3: GB CBRN Challenge Data for Selected Icons.....	A-18
Table A-4: Calculation of GB Effective CBRN Challenge for Selected Icons.....	A-19
Table A-5: Injury Profile Cohort Populations for GB Illustrative Example.....	A-21
Table A-6: Estimated Daily Number of New GB Casualties* .....	A-24
Table A-7: Estimated Personnel Status for GB Casualties* .....	A-24
Table A-8: Estimated Daily Number of New GB Casualties* .....	A-25
Table A-9: Estimated Personnel Status for GB Casualties* .....	A-25
Table A-10: CK Effective CBRN Challenge for Selected Icons.....	A-29
Table A-11: Injury Profile Cohort Populations for CK Illustrative Example.....	A-32
Table A-12: Inhaled CK Composite Injury Profiles.....	A-32
Table A-13: Estimated Daily Number of New CK Casualties* .....	A-34
Table A-14: Estimated Personnel Status for CK Casualties* .....	A-35
Table A-15: RDD CBRN Challenge Data for Selected Icons .....	A-38
Table A-16: RDD Effective CBRN Challenge for Selected Icons .....	A-39
Table A-17: Icon 26 Combined Injury Profile .....	A-40
Table A-18: Dose Range Combination Distribution Across the Task Force.....	A-40
Table A-19: Estimated Daily Number of New <sup>137</sup> Cs RDD Casualties* .....	A-42
Table A-20: Estimated Personnel Status for <sup>137</sup> Cs RDD Casualties* .....	A-43
Table A-21: Nuclear CBRN Challenge Data for Selected Icons .....	A-47
Table A-22: Calculation of Nuclear Effective CBRN Challenge for Selected Icons..A-48	
Table A-23: Nuclear Example Effective Challenge Summary for Task Force.....	A-49

Table A-24: Nuclear Example Effective Challenge Summary for Task Force ..... A-53  
 Table A-25: Estimated Daily Number of New Nuclear Casualties\* ..... A-59  
 Table A-26: Estimated Personnel Status for Nuclear Casualties\* ..... A-59  
 Table A-27: *B. anthracis* CBRN Challenge Data and Calculation of Effective CBRN  
 Challenge for Selected Icons ..... A-63  
 Table A-28: Populations of Anthrax Cohorts ..... A-64  
 Table A-29: Estimated Daily Number of New Anthrax Casualties\* ..... A-67  
 Table A-30: Estimated Personnel Status for Anthrax Casualties\* ..... A-67  
 Table A-31: Populations of Smallpox Cohorts ..... A-72  
 Table A-32: Estimated Daily Number of New Smallpox Casualties\* ..... A-75  
 Table A-33: Estimated Personnel Status for Smallpox Casualties\* ..... A-75  
 Table A-34: Estimated Daily Number of New Smallpox Casualties\* ..... A-81  
 Table A-35: Estimated Personnel Status for Smallpox Casualties\* ..... A-81



<b>CHAPTER 1 DESCRIPTION OF THE METHODOLOGY</b>
---

**1.1. INTRODUCTION AND DOCUMENT ORGANIZATION**

1. AMedP-7.5 provides a methodology for estimating casualties that occur over time following a chemical, biological, radiological, or nuclear (CBRN) incident.
2. The methodology begins by estimating each individual's CBRN challenge<sup>1</sup> resulting from a user-postulated CBRN incident. Next, human response to different agents and effects, as a function of the type and magnitude of CBRN challenge and CBRN countermeasures, is estimated. Human response is represented by Injury Profiles—descriptions of changing injury severity over time. Casualty status is then defined as a function of a user-specified casualty criterion.
3. The organization of this document is intended to facilitate understanding and implementation of the methodology.
  - a. Chapter 1 explains the terms and concepts underlying the methodology, describes in general terms how the inputs are used to generate the casualty estimate, and provides references to other NATO documents describing how the outputs may be used.
  - b. Chapter 2 fully describes the required and optional input (with examples), and describes how the utility of the output is affected by the user input.
  - c. Chapter 3 describes the general process and equations used to estimate each individual's CBRN challenge.
  - d. Chapters 4 and 5 fully describe the human response and casualty estimation processes for all included agents and effects, including all necessary equations and tables, and flowcharts that explicitly state the sequence of equations and tables necessary to estimate human response and casualties.
  - e. Chapter 6 describes how the casualty estimates from Chapters 4 and 5 are summed and reported in accordance with NATO standards.
  - f. Annex A provides step-by-step illustrative examples demonstrating how the methodology can be applied for a few selected incidents.
4. This document is supplemented by an associated Standards Related Document, *Technical Reference Manual to Allied Medical Publication 7.5 (AMedP-*

---

<sup>1</sup> In this document, "CBRN challenge" means an amount or degree of CBRN agent or effect. See Section 1.4 for additional definitions.

7.5) *NATO Planning Guide for the Estimation of CBRN Casualties* (hereafter referred to as the TRM)—see Table 1-6 for cross-references—which:

- a. Describes the sources for, and justification of, the assumptions, limitations, and constraints and recommended values employed by the methodology;
- b. Identifies, where appropriate, the sources for definitions and key terms used by the methodology, or else describes where and how new definitions and terms were derived;
- c. Documents the derivation and/or supporting reasoning for the modeled symptomatology and the associated parameter values, lookup tables, equations, assumptions, limitations, constraints, and Injury Profiles for each agent of effect included in the methodology;
- d. Provides a list of the references used in the development of this methodology and its human response models.

## 1.2. PURPOSE AND INTENDED USE

1. The purpose of this **document** is to describe a methodology for estimating casualties uniquely occurring as a consequence of CBRN incidents near Allied forces, in support of the planning processes described in Allied Joint Publication 3.8 (AJP-3.8), *Allied Joint Doctrine for NBC Defence*,<sup>2</sup> Allied Joint Publication 4.10 (AJP-4.10), *Allied Joint Medical Support Doctrine*,<sup>3</sup> Allied Joint Medical Publication 1 (AJMedP-1), *Allied Joint Medical Planning Doctrine*,<sup>4</sup> Allied Joint Medical Publication 7 (AJMedP-7), *Allied Joint Medical Doctrine for Support to CBRN Defensive Operations*,<sup>5</sup> and Allied Medical Publication 7.6 (AMedP-7.6), *Commander's Guide to Medical Support in Chemical, Biological, Radiological, and Nuclear Environments*.<sup>6</sup>

2. The purpose of the **methodology** is to estimate the number, type, severity, and timing of CBRN casualties.

---

<sup>2</sup> North Atlantic Treaty Organization (NATO), *AJP-3.8(A): Allied Joint Doctrine for CBRN Defence*, STANAG 2451 (Brussels, Belgium: NATO, March 2012).

<sup>3</sup> North Atlantic Treaty Organization (NATO), *AJP-4.10(B): Allied Joint Medical Support Doctrine*, STANAG 2228 (Brussels, Belgium: NATO, May 2015).

<sup>4</sup> North Atlantic Treaty Organization (NATO), *AJMedP-1: Allied Joint Medical Planning Doctrine*, STANAG 2542 (Brussels, Belgium: NATO, November 2009).

<sup>5</sup> North Atlantic Treaty Organization (NATO), *AJMedP-7: Allied Joint Medical Doctrine for Support to Chemical, Biological, Radiological, and Nuclear (CBRN) Defensive Operations*, STANAG 2596 (Brussels, Belgium: NATO, August 2015).

<sup>6</sup> North Atlantic Treaty Organization (NATO), *AMedP-7.6: Commander's Guide on Medical Support to Chemical, Biological, Radiological, and Nuclear (CBRN) Defensive Operations*, STANAG 2873 (Brussels, Belgium: NATO, study).

3. The purpose of **CBRN casualty estimates** is to assist planners, logisticians, and other staff officers in quantifying contingency requirements for medical force structure, specialty personnel, medical materiel, and patient transport or evacuation. Some example users and how they might use the output are:

- a. Operational planners may use CBRN casualty estimates to provide coordinating instructions to units or to assess unit casualty distributions when evaluating Courses of Action resulting from variations in a number of parameters, such as availability of medical countermeasures (e.g. prophylaxis). Allied Joint Publication 5 (AJP-5), Allied Joint Doctrine for Operational-Level Planning,<sup>7</sup> provides information for operational planners.
- b. Logistics planners may use CBRN casualty estimates to determine logistical requirements, both medical and non-medical, for the management of CBRN casualties. Allied Joint Publication 4 (AJP-4), Allied Joint Logistic Doctrine,<sup>8</sup> provides information for logistics planners.
- c. Personnel planners may use CBRN casualty estimates to plan for personnel replacements.
- d. Medical planners may use CBRN casualty estimates to identify medical resource requirements, such as pharmaceuticals, medical devices, medical supplies, bed types, and personnel specialties, for each role of medical treatment. Commanders, Medical Advisors, and Medical Directors may also use casualty estimates to evaluate medical courses of action. AMedP-7.6 and AJP-4.10 provide further information about planning for medical operations in CBRN environments.

4. The methodology described herein is of such complexity that it will be very difficult to execute it without a software-based implementation. Accordingly, the methodology is proposed solely for deliberate planning and is not intended for real-time use. Moreover, it is not intended for use in deployment health surveillance or for any post-incident uses including diagnosis, medical treatment, or epidemiology.

5. It is recommended that when this document is printed, it should be printed in color. There are many figures that use color to help visually convey information.

### 1.3. SCOPE

This document includes information necessary to estimate acute human response to a specific set of CBRN agents and effects. This set is not exhaustive, and other

---

<sup>7</sup> North Atlantic Treaty Organization (NATO), *AJP-5: Allied Joint Doctrine for Operational-Level Planning*, STANAG 2526 (Brussels, Belgium: NATO, June 2013).

<sup>8</sup> North Atlantic Treaty Organization (NATO), *AJP-4(A): Allied Joint Logistics Doctrine*, STANAG 2182 (Brussels, Belgium: NATO, March 2004).

agents or effects could be incorporated at a later time as permitted by the availability of adequate, credible data to enable model development.

### 1.3.1. Challenge Types

1. The phrase “challenge type” is used in several ways in this document.
  - a. It can be a generic descriptor, at the level of “chemical,” “biological,” “radiological,” or “nuclear.”
  - b. It can be slightly more specific by including the route of exposure, such as “inhaled chemical agent” or “nuclear blast.”
  - c. For chemical and biological agents, it can refer to the specific agent and route of exposure, such as “inhaled GB” or “inhaled *B. anthracis*.”
2. Chemical agents considered include tabun (GA), sarin (GB), soman (GD), cyclosarin (GF), VX, distilled sulfur mustard (HD), phosgene (CG), chlorine (Cl<sub>2</sub>), ammonia (NH<sub>3</sub>), hydrogen cyanide (AC), cyanogen chloride (CK), and hydrogen sulfide (H<sub>2</sub>S).

**Table 1-1: Chemical Agent Challenge Types**

Agent	Inhalation*	Percutaneous Vapour	Percutaneous Liquid
GA	X		
GB	X		
GD	X		
GF	X		
VX	X		X
HD	X	X	X
CG	X†		
Cl <sub>2</sub>	X		
NH <sub>3</sub>	X		
AC	X		
CK	X†		
H <sub>2</sub> S	X		

Note: this table is not intended to imply that the routes of exposure not included could not lead to injury; rather it is a statement of the scope of what is included in this methodology.

\* As warranted, based on the agent, ocular effects are also included within the “inhalation” models.

† Inhalation is considered in two ways: concentration time and peak concentration. See Sections 4.2.8 and 4.2.11 for further details.

3. Biological agents considered include the causative agents of anthrax, brucellosis, Eastern equine encephalitis virus (EEEV) disease, glanders, melioidosis, plague, Q fever, smallpox, tularemia, Venezuelan equine encephalitis virus (VEEV) disease, and Western equine encephalitis virus (WEEV) disease. Diseases caused by the biological toxins botulinum neurotoxin, ricin, staphylococcal enterotoxin B (SEB), and T-2 mycotoxin are also considered.

- a. Inhalation is the only challenge type considered for biological agents.

- b. Most agents listed above cause non-contagious diseases. For plague and smallpox, two separate models are provided: one for modeling them as “non-contagious” to represent effective isolation/quarantine, and another that considers the spread of contagious disease.
  - c. Ebola virus is notably absent from the list of included biological agents. Although it is recognized that Ebola virus is important, as an outbreak of Ebola Virus Disease (EVD) could cause a significant number of casualties, the 2014–2015 Ebola outbreak in West Africa has shown that previously developed human response models for EVD do not accurately reflect the propagation of disease within a population. Further, at the time this document was prepared, characterization of the 2014–2015 outbreak in the scientific literature was partial at best. Until more information on the 2014–2015 outbreak is published, confidence in the accuracy of any new EVD model will be low.
  - d. However, recognizing that in some situations, even outdated information may be better than no information at all, Section 5.2.18 contains approximations of parameter values for EVD, based largely on models that were developed *before* the 2014–2015 outbreak and some limited new information from the 2014–2015 outbreak. However, note that the information in Section 5.2.18 is intentionally presented in a format that *cannot* be easily used in the biological agent human response frameworks presented in this document.
4. Radiological agents are modeled for two source types: radiological dispersal devices (RDDs) and radioactive fallout resulting from a nuclear detonation.
- a. RDDs.
    - 1) The radioisotopes modeled are  $^{60}\text{Co}$ ,  $^{90}\text{Sr}$ ,  $^{99}\text{Mo}$ ,  $^{125}\text{I}$ ,  $^{131}\text{I}$ ,  $^{137}\text{Cs}$ ,  $^{192}\text{Ir}$ ,  $^{226}\text{Ra}$ ,  $^{238}\text{Pu}$ ,  $^{241}\text{Am}$ ,  $^{252}\text{Cf}$ .
    - 2) Whole-body irradiation (from cloudshine, groundshine,<sup>9</sup> and inhalation of radiological particles) and cutaneous radiation (from skin contamination, cloudshine, and groundshine) are the challenge types considered.
  - b. Fallout.
    - 1) Radioactive fallout deposited on the ground is not isotope-specific.
    - 2) Whole-body irradiation (from groundshine) and cutaneous radiation (from skin contamination and groundshine) are the challenge types considered.<sup>10</sup>
5. Prompt nuclear effects considered are:

---

<sup>9</sup> Cloudshine and groundshine are radioactive material in the air and on the ground, respectively.

<sup>10</sup> Note the exclusion of cloudshine and inhalation of radiological particles, which confers the assumption that the fallout cloud has settled.

- a. Whole-body external irradiation from initial ionising radiation (gamma and neutron radiation).
  - b. Primary blast effects (barotrauma) due to static overpressure, and lethal tertiary blast effects (whole-body translation coupled with decelerative tumbling) due to dynamic pressure (winds).
  - c. Partial thickness burns to skin due to thermal fluence.
6. Battle stress (also commonly referred to as “psychological”) and indirect effects (e.g., injuries resulting from car accidents following an incident, burns due to secondary fires, or opportunistic infections) are not considered.

### 1.3.2. Types of Casualty

The methodology estimates casualties with regard to the *medical* system, not the *personnel* system. Thus, it estimates killed in action (KIA), wounded in action (WIA), died of wounds received in action (DOW), convalescent (CONV), and return to duty (RTD) casualties, but does not estimate detained, captured, or missing casualties; for definitions of the included casualty categories, see Section 1.4.

### 1.3.3. Countermeasures

The methodology can account for the following types of countermeasures, which can provide the listed types of protection; for definitions, see Section 1.4.

- a. Individual protective equipment (IPE).
  - 1) Inhalation protection.
  - 2) Percutaneous liquid and vapour protection.
- b. Physical protection.
  - 1) Inhalation and percutaneous vapour protection.
  - 2) Percutaneous liquid protection.
  - 3) Gamma ray shielding.
  - 4) Neutron shielding.
  - 5) Blast shielding.
  - 6) Thermal shielding.
- c. Collective Protection (ColPro).
  - 1) Inhalation and percutaneous vapour protection.

- 2) Percutaneous liquid protection.
- d. Medical countermeasures.
  - 1) Dependent on the specific countermeasure.

#### 1.4. DEFINITIONS

1. Population at Risk (PAR): a group of individuals considered at risk of exposure to conditions which may cause injury or illness.<sup>11</sup> For this methodology, this is always the total number of personnel in the scenario, and is defined by user input.
2. Icon: a group of individuals sharing a common location over time. Each icon is given a unique numerical identifier and is associated with a set of attributes that is used to estimate what fraction of the CBRN Challenge will become the Effective CBRN Challenge (terms defined below).
3. CBRN Challenge:
  - a. The time-varying cumulative amount or degree of CBRN agent or effect estimated to be present in the physical environment with which icons are interacting.
  - b. For chemical agents with concentration-based effects, also includes the time-varying instantaneous (non-cumulative) concentration estimated to be present in the physical environment with which icons are interacting.
4. Effective CBRN Challenge: the cumulative (or in the case of a chemical agent peak concentration challenge, maximum instantaneous) amount or degree of CBRN agent or effect that is estimated to actually affect an icon, after accounting for the icon's attributes.<sup>12</sup> Used as input to the human response portion of the methodology. Per Table 1-2, this term is broadly used within the methodology to encompass a range of phenomena, the specific expression of which depends on the challenge type.
5. Individual protective equipment (IPE): "In chemical, biological, radiological and nuclear defence, the personal equipment intended to physically protect an individual from the effects of chemical, biological, radiological and nuclear substances."<sup>13</sup>
6. Physical protection: In chemical, biological, radiological and nuclear defence, a

---

<sup>11</sup> Note that this definition differs from AMedP-13(A), which says that all individuals in the PAR are exposed: See North Atlantic Treaty Organization (NATO), *AMedP-13(A): NATO Glossary of Medical Terms and Definitions*, STANAG 2409 (Brussels, Belgium: NATO, May 2011), 2-49.

<sup>12</sup> The definition of icon attributes is given on page 1-9.

<sup>13</sup> NTMS, NATO Agreed 2014-04-10.

vehicle or shelter that protects an individual from the effects of chemical, biological, radiological and nuclear substances.

7. Collective Protection (ColPro): “Protection provided to a group of individuals in a chemical, biological, radiological and nuclear environment, which permits relaxation of individual chemical, biological, radiological and nuclear protection.”<sup>14</sup>

**Table 1-2: Challenge Types and Associated Terminology**

Challenge Type	Specific Terminology for Effective CBRN Challenge
Inhaled Chemical Agent*†	Inhaled concentration time (Ct) Inhaled peak concentration
Percutaneous Chemical Agent* Vapour	Percutaneous vapour concentration time (Ct)
Percutaneous Chemical Agent* Liquid	Percutaneous liquid dose
Inhaled Biological Agent*	Inhaled dose
RDD or Fallout	Whole-body dose <sup>§</sup> Cutaneous dose <sup>§</sup>
Initial Ionising Radiation (Nuclear)	Whole-body dose <sup>§</sup>
Blast (Nuclear)	Blast insult <sup>15</sup>
Thermal (Nuclear)	Thermal insult

\* Challenge types include the specific chemical or biological agent name. Thus, example challenge types are Inhaled GB and Inhaled *B. anthracis*. Also, in reference to the word “inhaled,” note that, per paragraph 1.5.3, “inhaled” does not imply “retained” or “absorbed” dose.

† “Vapour” is not part of the challenge type label because inhaled chemical agent is intended to include contributions from both vapour and aerosols. Further, as noted previously, ocular effects are also included within the “inhalation” models, as warranted.

§ Throughout this document, the whole-body dose referred to should be taken as the free-in-air (FIA) dose that would be measured by instrumentation, not deep tissue or personal dose.

8. Medical Countermeasures: “Those medical interventions designed to diminish the susceptibility of personnel to the lethal and damaging effects of chemical, biological, and radiological hazards and to treat any injuries arising from challenge by such hazards.”<sup>16</sup> This document also includes nuclear hazards.

- a. Prophylaxis: medical countermeasures administered before the onset of signs and symptoms (can be pre- or post-exposure).
- b. Treatment: medical countermeasures administered after the onset of signs and symptoms. As warranted by the challenge type, first-aid/buddy aid and later medical treatment are considered separately

9. Protection Factor: “A measure of the effectiveness of a protective device or technique in preventing or reducing exposure to chemical, biological, radiological and

<sup>14</sup> NTMS, NATO Agreed 2009-08-26.

<sup>15</sup> An insult is “anything which tends to cause disease in or injury to the body or to disturb normal bodily processes,” per Oxford English Dictionary Online, s.v. “insult,” accessed October 4, 2013, <http://www.oed.com/view/Entry/97243>.

<sup>16</sup> NTMS, Not NATO Agreed 2006-07-01.



nuclear substances, or of a medical treatment in preventing or reducing the physiological effects of such substances.”<sup>17</sup> In this document, this is a factor by which the CBRN Challenge is reduced; for example, a mask protection factor of 10 reduces an inhaled *B. anthracis* dose from 100 spores to 10 spores. Protection factors are used to model the effects of IPE, physical protection, ColPro, and pre-exposure prophylaxis against Chemical/Radiological/Nuclear (CRN) challenges.

10. Aggregate Protection Factor (APF): a single protection factor used to represent all relevant<sup>18</sup> protection factors for an icon (based on icon attributes). Computed by multiplying all relevant protection factors, per Equation 2-2.

11. Icon attributes: a list of an icon’s identifying information and challenge-modifying attributes with associated protection factors. Challenge-modifying attributes and associated protection factors can change over time, as specified by the user. Default values are provided in Chapter 2.

12. Injury: general term that includes both wounds and disease.<sup>19</sup> Injuries may be caused by chemical, biological, radiological, radiation, blast, and thermal challenges.

13. Injury Severity Level: the degree of injury caused by the Effective CBRN Challenge, characterized by five integer levels and corresponding qualitative descriptions, as defined in Table 1-3. The definitions are expanded from those in AMedP-13 to include both medical requirements and operational capability.

14. Injury Profile: a tabular description of the progression of injury, expressed in terms of the step-wise Injury Severity Level changes over time, with time “zero” defined as the time at which the Effective CBRN Challenge stops accumulating.<sup>20</sup> Injury Profiles only show time points at which the Injury Severity Level changes. In some cases, the last entry in a CRN Injury Profile is non-zero, in which case it is assumed that, without medical treatment, full recovery never occurs.

15. Composite Injury Profile: an Injury Profile generated by overlaying multiple Injury Profiles and selecting the maximum Injury Severity Level at each time point. Only used to combine Injury Profiles for distinct injuries caused by a single chemical or radiological agent.

16. Casualty Criterion: the user-specified injury severity level used to determine whether an individual is wounded in action (WIA). The syntax and more specific

---

<sup>17</sup> NTMS, NATO Agreed 2014-04-10.

<sup>18</sup> Which protection factors are relevant depends on the challenge type.

<sup>19</sup> This is consistent with the usage found in AAP-6: North Atlantic Treaty Organization (NATO), *AAP-6: NATO Glossary of Terms and Definitions*, STANAG 3680 (Brussels, Belgium: NATO, April 2014), 2-W-2.

<sup>20</sup> The implied assumption, specifically stated in Section 1.5, is that each icon will receive its entire Effective CBRN Challenge prior to the onset of any symptoms.

definition for each of the possible choices for the casualty criterion are:<sup>21</sup>

- a. WIA(1<sup>+</sup>): an individual manifesting signs and/or symptoms of Severity Level 1 or greater is considered WIA.
- b. WIA(2<sup>+</sup>): an individual manifesting signs and/or symptoms of Severity Level 2 or greater is considered WIA.
- c. WIA(3<sup>+</sup>): an individual manifesting signs and/or symptoms of Severity Level 3 or greater is considered WIA.

**Table 1-3: Injury Severity Level Definitions**

	Degree	Description
0	<b>N.O.I.*</b>	Although some exposure to an agent or effect may have occurred, no observable injury (as would be indicated by manifested symptoms) has developed. Alternately, recovery from a prior injury is complete.
1	<b>Mild</b>	Injury is manifesting symptoms (and signs for biological agents) of such severity that individuals can care for themselves or be helped by untrained personnel. Condition may not impact the ability to conduct the assigned mission.
2	<b>Moderate</b>	Injury is manifesting symptoms (and signs for biological agents) of such severity that medical care may be required. General condition permits treatment as outpatient and some continuing care and relief of pain may be required before definitive care is given. Condition may be expected to interrupt or preclude the ability to conduct the assigned mission.
3	<b>Severe</b>	Injury is manifesting symptoms (and signs for biological agents) of such severity that there is cause for immediate concern, but there is no imminent danger to life. Individual is acutely ill and likely requires hospital care. Indicators are questionable—condition may or may not reverse without medical intervention. Individual is unable to conduct the assigned mission due to the severity of the injury.
4	<b>Very Severe</b>	Injury is manifesting symptoms (and signs for biological agents) of such severity that life is imminently endangered. Indicators are unfavorable—condition may or may not reverse, even with medical intervention. Prognosis is death without medical intervention. Individual is unable to conduct the assigned mission due to severity of injury.

\* N.O.I. = No Observable Injury.

Note: these definitions are intended for use in casualty estimation, not triage. Thus, they are suitable for casualty estimation, not triage.

#### 1.4.1. Types of Casualty

1. Casualty: “With regard to the medical system, a person who is lost to an organization by reason of having been declared dead, wounded, injured, or diseased.”<sup>22</sup>

<sup>21</sup> Note that since “Severe” symptoms are defined as those which preclude an individual’s ability to conduct the assigned mission, a casualty criterion of WIA(4<sup>+</sup>) is not allowed.

<sup>22</sup> NTMS, NATO Agreed 2013-05-14.

2. Chemical casualty: “A casualty caused by exposure to a chemical substance.”<sup>23</sup>
3. Biological casualty: “A casualty caused by exposure to a biological agent.”<sup>24</sup>
4. Radiological casualty: “A casualty caused by exposure to ionising radiation.”<sup>25</sup>
5. Nuclear casualty: “A casualty caused by exposure to nuclear flash, blast, heat, or radiation.”<sup>26</sup> Flash blindness is not considered in this document.
6. Wounded in Action (WIA): “a battle casualty other than ‘killed in action’ who has incurred an injury due to an external agent or cause as a result of hostile action. Note: The term encompasses all kinds of wounds and other injuries incurred in action, whether there is a piercing of the body, as in a penetrating or perforated wound, or none, as in the contused wound; all fractures, burns, blast concussions, all effects of biological and chemical warfare agents, the effects of exposure to ionising radiation or any other destructive weapon or agent.”<sup>27</sup>
7. Killed in Action (KIA): “a battle casualty who was killed outright or who died before reaching a medical treatment facility.”<sup>28</sup> By definition, in this document, a KIA was previously WIA. Also by definition, as described in Section 1.6.1.5.c, KIAs occur within 24 hours of the injury.
8. Died of Wounds received in action (DOW): “a battle casualty who died after having entered the medical care system.”<sup>29</sup> To be consistent with the definition of KIA, “the medical care system” is taken to mean a Role 1 or higher Medical Treatment Facility (MTF); if a casualty dies during evacuation to the medical care system, s/he is considered KIA. By definition, in this document, a DOW was previously WIA.
9. Convalescent (CONV): a patient who is “mostly ambulatory [and] requires limited therapeutic intervention and administration of oral medications performed by the patient.”<sup>30</sup> Alternatively, patients who are evacuated out of theatre for long-term recovery. Thus, a CONV was previously WIA, but currently requires either no or minimal in-theatre medical resources. Casualties whose recovery time can be

---

<sup>23</sup> NTMS, NATO Agreed 2014-06-25.

<sup>24</sup> Although this definition is consistent with the definitions for chemical, radiological, and nuclear casualty, as of 2014-09-19 it is only a proposed definition, and is awaiting confirmation, per NATO NSO TTF Tracker 2012-0029, “biological casualty.” There is no NTMS entry for “biological casualty.”

<sup>25</sup> NTMS, NATO Agreed 2014-06-25.

<sup>26</sup> NTMS, NATO Agreed 2014-06-25.

<sup>27</sup> NATO, *AMedP-13(A)*, 2-65. Note that this definition differs from the NTMS, which states that a WIA “has incurred a non-fatal injury,” thereby precluding the possibility that a WIA can later die—an incorrect definition.

<sup>28</sup> NTMS, NATO Agreed 2011-11-07.

<sup>29</sup> NTMS, NATO Agreed 2011-11-07.

<sup>30</sup> NATO, *AMedP-13(A)*, 2-15.

estimated will RTD; those with an unknown period of recovery or long-term/permanent disability will remain CONV.

10. Return to Duty (RTD): “The administrative process of releasing a patient from medical treatment facility to his or her unit.”<sup>31</sup> Thus, an RTD was previously WIA (and possibly CONV), but has recovered without leaving the theatre. This methodology does not consider the impact of theatre evacuation policy on RTD—individuals in the RTD category are simply *available* to return to duty.

11. Casualty category: a group of casualties with a common prognosis and/or needing approximately the same level of medical treatment.<sup>32</sup> In the context of this document, the casualty category can be KIA, WIA, DOW, CONV, and RTD. As warranted, the WIA category can also be further subdivided based on the Injury Severity Level, into WIA(1), WIA(2), WIA(3), and WIA(4). The label “WIA” will be used to refer to WIAs generally, and the label “WIA( # )” will be used to refer collectively to the four subdivisions when the specific value of # is important.

## 1.5. GENERAL ASSUMPTIONS, LIMITATIONS, AND CONSTRAINTS

### 1. Assumptions.

- a. Individuals are normally healthy—they have no pre-existing physiological injury or condition that would alter human response.
- b. Human response begins after the challenge ends—each icon receives its entire Effective CBRN Challenge prior to the onset of any symptoms, and there is a common “time zero” at which human response begins for every individual in the scenario.
- c. Parameter values derived from *animal models* (mostly non-human primates) are applicable to *human* response models and casualty estimation.
- d. Medical treatment facilities have unlimited resources.
- e. When medical treatment is modeled, casualties reach an MTF within one day of the time at which they begin to seek medical treatment.

### 2. Limitations.

- a. Explosive trauma casualties are not considered.

---

<sup>31</sup> NTMS, NATO Agreed 2014-06-25.

<sup>32</sup> The NTMS defines casualty category as “A group of casualties having the same type of injury and causation, as used in medical planning,” and gives examples including KIA, WIA, and DOW (NATO Agreed 2011-11-07). This definition makes little sense, as there are many types of injury that might cause an individual to become KIA, WIA, or DOW. The definition used in this document follows the idea of the examples given by the NTMS (KIA, WIA, and DOW) by including CONV and RTD.

- b. Casualties resulting from secondary/indirect effects such as battle stress, burns due to secondary fires, and opportunistic infections, are not considered.
  - c. The potential for administrative declaration of “casualties” or delay of RTD out of precaution is not considered.
3. Constraint. For inhalation challenges, the methodology uses an estimated *inhaled* challenge, rather than an estimated *retained* (or absorbed) challenge.<sup>33</sup>

## 1.6. SUMMARY OF THE METHODOLOGY

The five major steps of the methodology are:

- a. INPUT: define icons, icon attributes, CBRN Challenge per icon over time,<sup>34</sup> and values of four methodology parameters. Must be provided by the user.
- b. CHALLENGE: estimate Effective CBRN Challenge per icon.
- c. RESPONSE: estimate distribution of human response in the PAR over time.
- d. STATUS: estimate distribution of casualties in the PAR over time.
- e. REPORT: report the numbers of new and total casualties in each casualty category over time.

### 1.6.1. INPUT

1. The user must determine how personnel should be grouped into icons.
2. The user must provide either the CBRN Challenge per icon over time, or the Effective CBRN Challenge per icon. In either case, the CBRN challenge data must be generated using *national tools*—there is no NATO standardized method of generating CBRN challenge estimates (ATP-45<sup>35</sup> predicts hazard *areas*, but not hazard *magnitudes*). If multiple challenges<sup>36</sup> are to be modeled, separate input must be provided for each challenge.
3. If the user provides the CBRN Challenge per icon over time, the user is advised

---

<sup>33</sup> Hazard predictions and the data underlying the parameter values in this document almost invariably relate to the amount of agent inhaled, not the amount retained after exhalation or the amount absorbed.

<sup>34</sup> Alternately, the user can provide the Effective CBRN Challenge per icon, in which case the second step is skipped.

<sup>35</sup> North Atlantic Treaty Organization (NATO), *ATP-45(E): Warning and Reporting and Hazard Prediction of Chemical, Biological, Radiological and Nuclear Incidents (Operators Manual)*, STANAG 2103 (Brussels, Belgium: NATO, January 2014). NATO UNCLASSIFIED.

<sup>36</sup> Multiple challenges can occur as a result of a single incident (nuclear detonation) or multiple incidents (e.g. GB and an RDD).

to also provide input for the icon attributes over time, such that the estimate will better reflect the user's planning scenario.

- a. For example, using input for the icon attributes over time, the methodology can reflect the impacts of icon movement, changes in respiratory minute volume (e.g., due to sprinting to cover), and changing defensive postures (e.g. due to warning and response). Chapter 2 contains guidance on providing this input.
  - b. If no input is provided for icon attributes over time, default values will be used (see Table 2-1).
4. If the user provides Effective CBRN Challenge per icon, no other information is necessary—it is assumed that the user has already accounted for all relevant icon attributes.
  5. The user must also determine whether to use default values or specify alternate values for five methodology parameters, discussed below, that affect the RESPONSE and STATUS steps.
    - a. Medical Treatment Flag ( $Flag_{MT}$ ). A binary parameter that determines whether the effects of medical treatment are modeled. If set to NO, the “Untreated” models are used; in general, these models reflect no medical treatment.<sup>37</sup> If set to YES, the “Treated” human response models are used; these models are intended to reflect all available medical treatment. The default value is YES.
    - b. Time at Injury Severity Level 4 sufficient to cause death from untreated chemical, nuclear blast, or nuclear burn injuries ( $T_{death-CN-SL4}$ ). Untreated<sup>38</sup> casualties with a chemical, nuclear blast, or nuclear burn injury that spend this threshold amount of time at Injury Severity Level 4 are assumed to die. The default value is 15 minutes.
    - c. Time to reach a medical treatment facility ( $T_{MTF}$ ). The time required for an individual who is WIA to reach a MTF. Given the definitions of KIA and DOW,  $T_{MTF}$  determines whether a WIA who dies is KIA or DOW (see Figure 1-2). The default value is 30 minutes, and a user can specify any value up to (but excluding) 1 day—the methodology is built around the assumption that casualties reach an MTF *within* one day of becoming WIA.
    - d. The casualty criterion. The user-specifiable injury severity threshold above which an individual is declared WIA. The user may choose between WIA(1+), WIA(2+), and WIA(3+). WIA(1+) will typically result in individuals being declared casualties and then reporting to the medical system sooner than would WIA(2+) or WIA(3+) (see Figure 1-1). Methodologically, reporting to the medical

---

<sup>37</sup> Models derived from animal data truly reflect no medical treatment. However, some of the biological agent models are derived from human data and include the effects of supportive care.

<sup>38</sup> Or *not yet treated* casualty en route to an MTF.

system for injuries of lower severity results in fewer deaths and more personnel in the medical system (individuals are less likely to die before reaching an MTF). The default value is WIA(1+).

- e. The day on which antibiotic or antitoxin treatment begins ( $d_{\text{trt-Q}}$ ). For some bacterial diseases and for botulism, an individual's prognosis and/or duration of illness depend upon when treatment with antibiotic or antitoxin begins. The methodology default value is day 1, which is likely to be optimistic.

6. A final aspect of user input is that the user may edit any parameter value in the methodology. All given parameter values should be considered the default or recommended value, but users who wish to change values may do so. However, users must be cautious to use realistic parameter values, or odd results may occur.

### 1.6.2. CHALLENGE

1. If the user provided the CBRN Challenge per icon over time, the methodology uses those values and the values of the icon attributes over time to estimate the Effective CBRN Challenge per icon.
2. If the user provided the Effective CBRN Challenge per icon, the values are not modified.
3. Regardless of whether it was estimated or directly provided by the user, the Effective CBRN Challenge is passed as input to the human response model.

### 1.6.3. RESPONSE and STATUS

1. The RESPONSE and STATUS steps are intertwined and are discussed together. Chapter 4 discusses them for CRN challenges, and Chapter 5 discusses them for biological challenges. Although there are general CRN, non-contagious biological, and contagious biological *frameworks*, the human response models vary widely among different challenge types, even within the same framework. Thus, the human response model used is specific to the challenge.

2. The specific human response models are summarized in the flowcharts at the end of the challenge-specific sub-sections of Section 4.2, 4.3, 4.4, and 5.2. In each case, the flowchart *begins* with taking the Effective CBRN Challenge as input, and by the *end*, the distribution of Injury Severity Levels and deaths in the PAR over time have been estimated.

3. Based on the output of the human response model five methodology parameters discussed above (Section 1.6.1, paragraph 5), the methodology estimates the distribution of casualties in the PAR over time.

- a. Figure 1-1 depicts how the casualty criterion and an individual's Injury Severity Level are used to determine whether the individual becomes WIA. The *time* at which the individual becomes a casualty depends upon the human response

model, which dictates when the individual's Injury Severity Level changes.

- b. Figure 1-2 shows the process for assigning casualty category as a function of time for any individual. In general, an individual becomes a casualty when his Injury Severity Level first meets or exceeds the casualty criterion. All other casualty categories are assigned after an individual is first declared WIA per Figure 1-1.

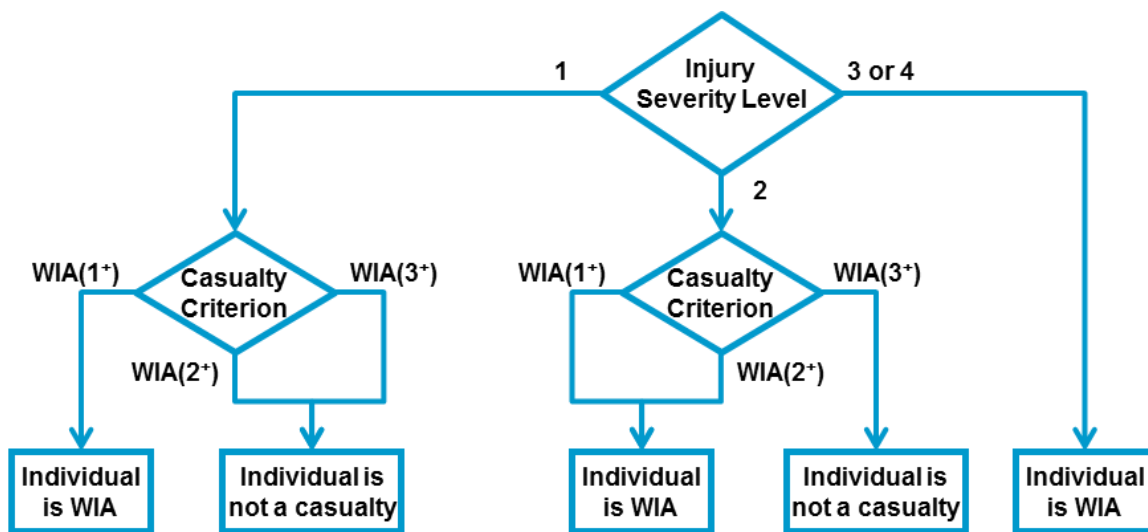

**Figure 1-1: Relationship of Casualty Criterion, Injury Severity Level, and WIA**

4. Composite Injury Profiles (for chemical and radiological agents) are the only means by which the methodology accounts for synergy between different injuries. Composite Injury Profiles are used to represent multiple challenge types from a single chemical or radiological agent (e.g., VX inhalation and percutaneous, or RDD cutaneous and whole body), but not of multiple chemical or radiological agents (e.g., VX and an RDD together).



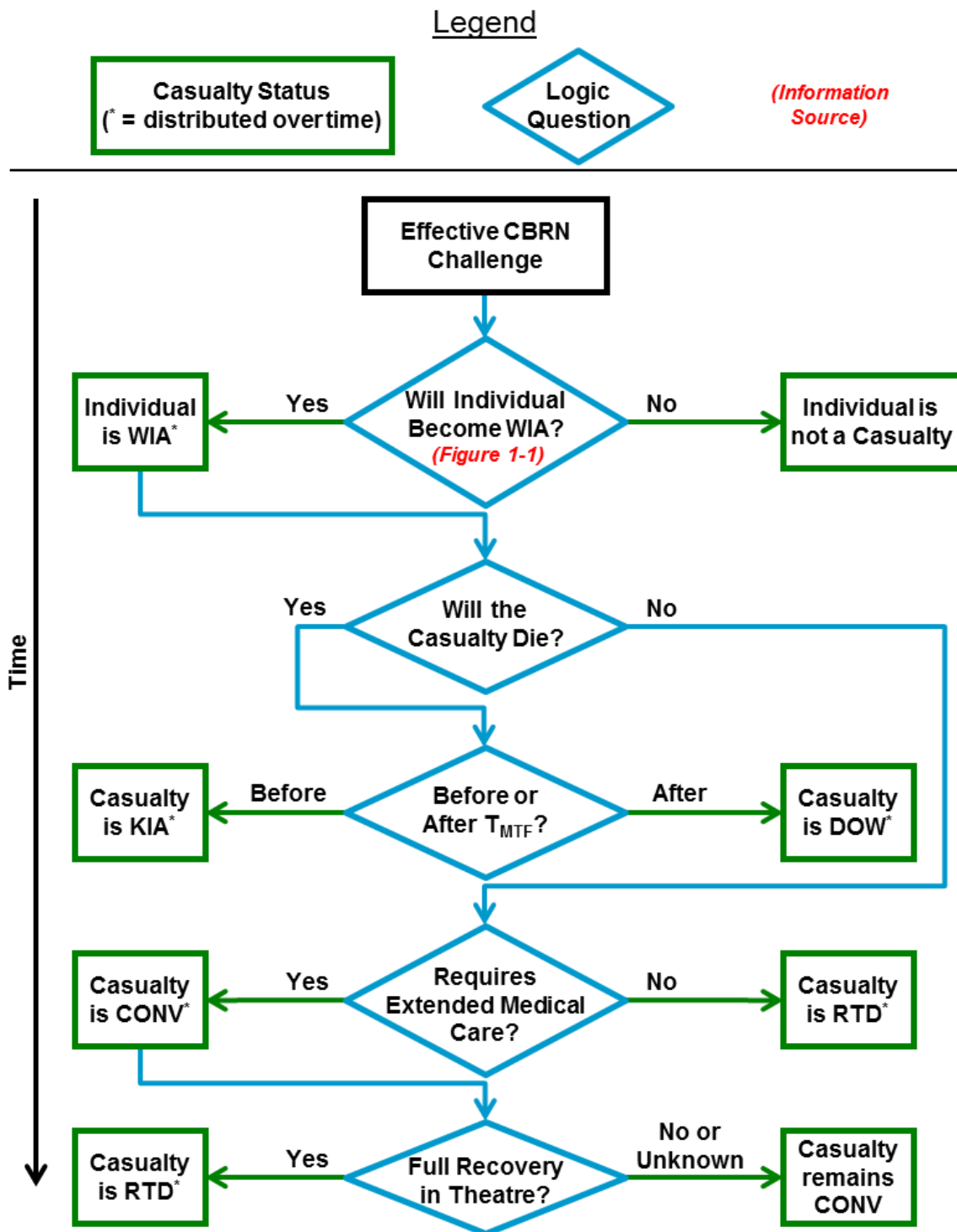

Note: if a casualty is assigned to more than one category in a calendar day, the rules specified in section 1.6.4.3 determine how the casualty is reported

**Figure 1-2: Decision Tree for Assignment of Casualty Category**

#### 1.6.4. REPORT

1. Per guidance from AJP-4.10, the four required outputs are labeled PAR, rates, flow, and profile. These provide an estimate of how many casualties occur, when they occur, the types of injury, and when changes in casualty category are expected to occur. An additional type of output, labeled “personnel status,” is also reported. Personnel status refers to the *total* number of casualties in a category on a certain day; this is contrasted to the rate, which only refers to *new* casualties.

- a. The PAR is simply the total number of personnel included in the scenario—a user input.
  - b. Output tables
    - 1) The rate table presents the number of *new* casualties in each category per day.<sup>39</sup> It reports WIA without subdividing by Injury Severity Level. This form of output will be most useful for operational and personnel planners.
    - 2) The personnel status table, which is not an AJP-4.10 requirement, reports the number of total casualties in each category on each day, with WIA subdivided by Injury Severity Level. Its purpose is to give an overall picture of the status of the force on each day. This form of output will be most useful for logistics and medical planners.
  - c. The flow characterizes the movement between casualty categories.<sup>40</sup> The casualty flow is presented within the rate tables.
  - d. The profile is a description of the relative proportions of types of injuries. Some example injury types in the context of this document are “WIA—mild rad”, “CONV—GB,” and “KIA—C” (where C indicates “chemical”). The casualty profile is presented within the rate tables.
2. Reports are generated with a time resolution of one day; this is fixed.
3. As it is possible for an individual to be assigned to multiple casualty categories within a *single* day, the rules in Table 1-4 are followed to facilitate more appropriate resource planning and to avoid double-counting.

---

<sup>39</sup> AJP-4.10 also mentions the option to report a *proportional* rate. Although this is not included in the methodology, it can easily be calculated by the planner: simply multiply the actual rate by 100 and divide by the PAR.

<sup>40</sup> AJP-4.10 also describes flow as characterizing how the timing of casualties depends on when incidents occur, which is beyond the purview of this document.

**Table 1-4: Casualty Reporting Rules**

Rule for Reporting the Value of # in WIA(#) for Personnel Status Tables			
Initial Category, Day X	Highest Severity, Day X	Report As, Day X	Report As, Day X+1
WIA(#)	WIA(#+(1, 2, or 3))	WIA(#+(1, 2, or 3))*	(no specific rule)
Rules for New Casualty and Personnel Status Tables			
Initial Category, Day X	Final Category, Day X	Report As, Day X	Report As, Day X+1
WIA	KIA <sup>§</sup>	KIA	KIA
WIA	DOW	WIA <sup>†</sup>	DOW
WIA	CONV	WIA <sup>†</sup>	CONV
WIA	RTD	WIA <sup>†</sup>	RTD
CONV	RTD	CONV	RTD

\* In other words, for personnel status tables, always report the *highest* severity (value of #) that occurred on that day.

† For personnel status tables, the Injury Severity Level must also be included (e.g., WIA(2)).

§ By definition, this can only occur on day 1.

4. One point related to Table 1-4 warrants additional clarification. If, for example, an individual is RTD as of 72 hours (the end of Day 3 and start of Day 4), the individual should be reported as RTD on Day 4, because the individual ended Day 3 as RTD (at no point on Day 4 is the Injury Severity Level greater than zero). However, if the individual was RTD as of 73 hours, that individual would be reported as WIA on Day 4 and RTD on Day 5.

5. Reporting continues until no further changes in casualty category occur.

### 1.6.5. User Aids

1. Figure 1-3 provides a methodology overview.

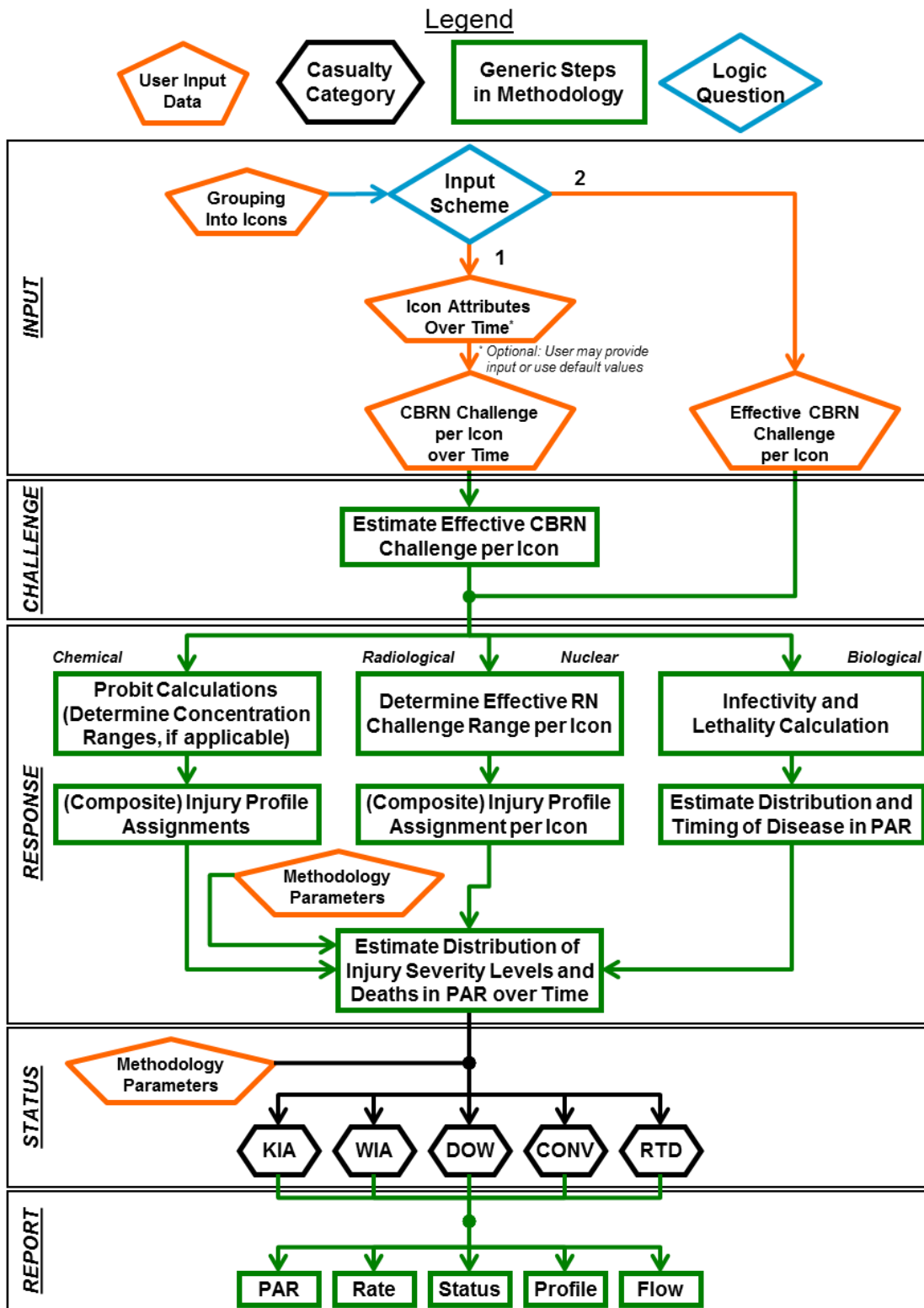

Figure 1-3: AMedP-7.5 Methodology Overview

2. Table 1-5 is a roadmap for the user. For each agent, effect, or disease, it specifies the section of this document to be used to complete each of the five steps described above.

**Table 1-5: User's Roadmap**

Agent, Effect, or Disease	Five Steps			
	INPUT	CHALLENGE	RESPONSE/STATUS	REPORT
Chemical				
GA	Ch. 2	Ch. 3	Sections 4.2.2 and 4.1	Ch. 6
GB	Ch. 2	Ch. 3	Sections 4.2.3 and 4.1	Ch. 6
GD	Ch. 2	Ch. 3	Sections 4.2.4 and 4.1	Ch. 6
GF	Ch. 2	Ch. 3	Sections 4.2.5 and 4.1	Ch. 6
VX	Ch. 2	Ch. 3	Sections 4.2.6 and 4.1	Ch. 6
HD	Ch. 2	Ch.3 and Section 4.2.7.3	Sections 4.2.7 and 4.1	Ch. 6
CG	Ch. 2	Ch. 3	Sections 4.2.8 and 4.1	Ch. 6
Cl <sub>2</sub>	Ch. 2	Ch. 3	Sections 4.2.9 and 4.1	Ch. 6
NH <sub>3</sub>	Ch. 2	Ch. 3	Sections 4.2.10 and 4.1	Ch. 6
AC	Ch. 2	Ch. 3	Sections 4.2.11 and 4.1	Ch. 6
CK	Ch. 2	Ch. 3	Sections 4.2.12 and 4.1	Ch. 6
H <sub>2</sub> S	Ch. 2	Ch. 3	Sections 4.2.13 and 4.1	Ch. 6
Radiological				
RDD	Ch. 2	Ch. 3 and Section 4.3.2.3	Sections 4.3.2 and 4.1	Ch. 6
Fallout	Ch. 2	Ch. 3 and Section 4.3.3.3	Sections 4.3.3 and 4.1	Ch. 6
Nuclear				
Initial Whole-Body Radiation	Ch. 2	Ch. 3 and Section 4.4.2.2	Sections 4.4.2 and 4.1	Ch. 6
Blast	Ch. 2	Ch. 3	Sections 4.4.3 and 4.1	Ch. 6
Thermal Fluence	Ch. 2	Section 4.4.4.2	Sections 4.4.4 and 4.1	Ch. 6
Biological				
Anthrax	Ch. 2	Ch. 3	Sections 5.2.1 and 5.1.4	Ch. 6
Brucellosis	Ch. 2	Ch. 3	Sections 5.2.2 and 5.1.4	Ch. 6
Glanders	Ch. 2	Ch. 3	Sections 5.2.3 and 5.1.4	Ch. 6
Melioidosis	Ch. 2	Ch. 3	Sections 5.2.4 and 5.1.4	Ch. 6
Plague (isolation/quarantine)	Ch. 2	Ch. 3	Sections 5.2.5 and 5.1.4	Ch. 6
Plague (contagious)	Ch. 2	Ch. 3	Sections 5.2.6 and 5.1.5	Ch. 6
Q Fever	Ch. 2	Ch. 3	Sections 5.2.7 and 5.1.4	Ch. 6
Tularemia	Ch. 2	Ch. 3	Sections 5.2.8 and 5.1.4	Ch. 6
Smallpox (isolation/quarantine)	Ch. 2	Ch. 3	Sections 5.2.9 and 5.1.4	Ch. 6
Smallpox (contagious)	Ch. 2	Ch. 3	Sections 5.2.10 and 5.1.5	Ch. 6
EEEV disease	Ch. 2	Ch. 3	Sections 5.2.11 and 5.1.4	Ch. 6
VEEV disease	Ch. 2	Ch. 3	Sections 5.2.12 and 5.1.4	Ch. 6
WEEV disease	Ch. 2	Ch. 3	Sections 5.2.13 and 5.1.4	Ch. 6
Botulism	Ch. 2	Ch. 3	Sections 5.2.14 and 5.1.4	Ch. 6
Ricin Intoxication	Ch. 2	Ch. 3	Sections 5.2.15 and 5.1.4	Ch. 6
SEB Intoxication	Ch. 2	Ch. 3	Sections 5.2.16 and 5.1.4	Ch. 6
T-2 Mycotoxicosis	Ch. 2	Ch. 3	Sections 5.2.17 and 5.1.4	Ch. 6

*Note:* Information on Ebola Virus Disease can be found in Section 5.2.18.

3. For additional information, Table 1-6 lists the cross-references between part(s) of this document and the corresponding part(s) of the TRM. Note that some portions of AMedP-7.5 do not have a corresponding section in the TRM because no further explanation was deemed necessary. Likewise, some portions of the TRM do not have a corresponding section in AMedP-7.5 because those parts provide background supporting information, but are not necessary for the execution of a casualty estimate.

**Table 1-6: Cross-References for AMedP-7.5 and Its Technical Reference Manual**

Topic	AMedP-7.5	TRM
Description of the Methodology	Chapter 1	Chapter 2
• Introduction and Document Organization	Section 1.1	N/A <sup>†</sup>
• Purpose and Intended Use	Section 1.2	N/A <sup>†</sup>
• Scope	Section 1.3	N/A <sup>†</sup>
• Definitions	Section 1.4	Section 2.B
• General Assumptions, Limitations, and Constraints	Section 1.5	Section 2.C
• Summary of the Methodology	Section 1.6	N/A <sup>†</sup>
User Input	Chapter 2	Chapter 3
• Overview of and Default Values for Challenge-Modifying Icon Attributes	Section 2.1.1	Section 3.A
○ Respiratory Minute Volume	Section 2.1.3, Table 2-1	Section 3.A.1
○ Body Surface Area	Section 2.1.4, Table 2-1	Section 3.A.2
○ IPE	Section 2.1.5, Table 2-1	Section 3.A.3
○ Vehicles and Shelters	Section 2.1.6, Table 2-1	Section 3.A.4
○ Pre-exposure Prophylaxis	Section 2.1.7, Table 2-1	Section 3.A.5
○ Uniform	Section 2.1.8, Table 2-1	Section 3.A.6
○ Aggregate Protection Factor	Section 2.1.9	N/A <sup>†</sup>
• CBRN Challenge and Effective CBRN Challenge	Section 2.1.2	Section 3.B
• Example Input and Input Schemes	Section 2.1.10	N/A <sup>†</sup>
• Default Values of Methodology Parameters	Table 2-14	Section 3.C
Calculation of Effective CBRN Challenge	Chapter 3	N/A <sup>†</sup>
Research Approach for the Development of Agent Models	N/A <sup>†</sup>	Chapter 4
CRN Human Response and Casualty Estimation	Chapter 4	Chapters 5–17
• CRN Model Framework	Section 4.1	N/A <sup>†</sup>
○ CRN Injury Profiles	Section 4.1.1	N/A <sup>†</sup>
○ Assignment of Personnel to Injury Profiles	Section 4.1.2	Section 5.D
○ Casualty Estimation	Section 4.1.3	N/A <sup>†</sup>
• Chemical Agent Assumptions and Constraint	Section 4.2.1	Section 5.A
• Chemical Agent Toxicity Source Documents	N/A <sup>†</sup>	Section 5.B
• Transition from AMedP-8(C) Threshold Model to AMedP-7.5 Probit Model	N/A <sup>†</sup>	Section 5.C
• Nerve Agent Models (GA, GB, GD, GF, and VX)	Sections 4.2.2 to 4.2.6	Chapter 6
○ Assumptions and Limitations	Sections 4.2.2.2, 4.2.3.2, 4.2.4.2, 4.2.5.2, and 4.2.6.2	Section 6.B
○ Physiological Effects	Tables 4-1, 4-4, 4-7, 4-10, 4-13, and 4-15	Section 6.C

<b>Topic</b>	<b>AMedP-7.5</b>	<b>TRM</b>
○ Injury Profiles	Tables 4-2, 4-5, 4-8, 4-11, 4-14, and 4-16	Section 6.D
○ Toxicity Parameters	Tables 4-1, 4-4, 4-7, 4-10, 4-13, and 4-15	Section 6.E
○ Medical Treatment	Tables 4-3, 4-6, 4-9, 4-12, and 4-17	Section 6.F
● HD Model	Section 4.2.7	Chapter 7
○ Assumptions	Section 4.2.7.2	Section 7.B
○ Physiological Effects	Tables 4-19, 4-21, and 4-23	Section 7.C
○ Injury Profiles	Tables 4-20, 4-22, and 4-24	Section 7.D
○ Toxicity Parameters	Tables 4-19, 4-21, and 4-23	Section 7.E
○ Medical Treatment	Table 4-25	Section 7.F
● CG Model	Section 4.2.8	Chapter 8
○ Assumptions	Section 4.2.8.2	Section 8.B
○ Physiological Effects	Tables 4-26 and 4-28	Section 8.C
○ Toxicity Parameters and Concentration Ranges	Tables 4-26 and 4-28	Section 8.D
○ Injury Profiles	Tables 4-27 and 4-29	Section 8.E
○ Medical Treatment	Table 4-30	Section 8.F
● Cl <sub>2</sub> Model	Section 4.2.9	Chapter 9
○ Assumptions	Section 4.2.9.2	Section 9.B
○ Physiological Effects	Table 4-31	Section 9.C
○ Toxicity Parameters	Table 4-31	Section 9.D
○ Injury Profile	Table 4-32	Section 9.E
○ Medical Treatment	Table 4-33	Section 9.F
● NH <sub>3</sub> Model	Section 4.2.10	Chapter 10
○ Assumptions	Section 4.2.10.2	Section 10.B
○ Physiological Effects	Table 4-34	Section 10.C
○ Toxicity Parameters	Table 4-34	Section 10.D
○ Injury Profiles	Table 4-35	Section 10.E
○ Medical Treatment	Table 4-36	Section 10.F
● AC Model	Section 4.2.11	Chapter 11
○ Assumptions	Section 4.2.11.2	Section 11.B
○ Physiological Effects	Table 4-37	Section 11.C
○ Toxicity Parameters	Table 4-37	Section 11.D
○ Injury Profiles	Table 4-38	Section 11.E
○ Medical Treatment	Table 4-39	Section 11.F
● CK Model	Section 4.2.12	Chapter 12
○ Assumptions	Section 4.2.12.2	Section 12.B
○ Physiological Effects	Tables 4-40 and 4-42	Section 12.C
○ Toxicity Parameters and Concentration Ranges	Tables 4-40 and 4-42	Section 12.D
○ Injury Profiles	Tables 4-41 and 4-43	Section 12.E
○ Medical Treatment	Table 4-44	Section 12.F
● H <sub>2</sub> S Model	Section 4.2.13	Chapter 13
○ Assumptions	Section 4.2.13.2	Section 13.B
○ Physiological Effects	Table 4-45	Section 13.C
○ Toxicity Parameters	Table 4-45	Section 13.D
○ Injury Profiles	Table 4-46	Section 13.E
○ Medical Treatment	Table 4-47	Section 13.F
● Radiological Agents (RDDs and Fallout)	Section 4.3	Chapters 14 and 15

<b>Topic</b>	<b>AMedP-7.5</b>	<b>TRM</b>
○ General Assumptions and Limitations	Section 4.3.1	Section 14.A
○ RDD Assumptions, Limitations, and Constraint	Section 4.3.2.2	Section 15.B
○ RDD Calculation of Doses	Section 4.3.2.3	N/A*
○ Fallout Assumptions, Limitations, and Constraint	Section 4.3.3.2	Section 15.C
○ Fallout Calculation of Doses	Section 4.3.3.3	N/A*
○ Threshold Lethal Dose and Time to Death	Section 4.3.4	Section 14.C
○ Physiological Effects	Tables 4-49 and 4-52	Section 15.E
○ Injury Profiles	Tables 4-50 and 4-53	Section 15.F
○ Dose Ranges	Tables 4-49 and 4-52	Section 15.G
○ Medical Treatment	Tables 4-51 and 4-54	Section 15.H
● Nuclear Effects Assumptions and Limitations	Section 4.4.1	Section 14.B
● Nuclear: Initial Whole Body Radiation	Section 4.4.2	Chapters 14 and 15
○ Assumption	Section 4.4.2.2	Section 15.D
○ Calculation of Dose	Section 4.4.2.3	N/A*
○ Threshold Lethal Dose and Time to Death	Section 4.4.2.4	Section 14.C
○ Physiological Effects	Tables 4-49 and 4-52	Section 15.E
○ Dose Ranges	Tables 4-49 and 4-52	Section 15.F
○ Injury Profiles	Tables 4-50 and 4-53	Section 15.G
○ Medical Treatment	Tables 4-51 and 4-54	Section 15.H
● Nuclear: Blast	Section 4.4.3	Chapter 16
○ Limitations and Constraints	Section 4.4.3.2	Section 16.B
○ Physiological Effects	Table 4-55	Section 16.C
○ Insult Ranges	Table 4-55	Section 16.D
○ Injury Profiles	Table 4-56	Section 16.E
○ Lethal Tertiary Effects	Section 4.4.3.4	Section 16.F
○ Medical Treatment	Table 4-57	Section 16.G
● Nuclear: Thermal Fluence	Section 4.4.4	Chapter 17
○ Assumptions, Limitations and Constraint	Section 4.4.4.2	Section 17.B
○ Calculation of Effective Insult	Section 4.4.4.3	Section 17.G
○ Physiological Effects	Table 4-60	Section 17.C
○ Insult Ranges	Table 4-60	Section 17.D
○ Injury Profiles	Table 4-61	Section 17.E
○ Medical Treatment	Table 4-62	Section 17.F
Biological Human Response and Casualty Estimation	Chapter 5	Chapters 18–33
● Human Response Submodels	Section 5.1.1	Section 18.B
● Casualty Estimation	Section 5.1.2	N/A*
● Assumptions and Limitations	Section 5.1.3	Section 18.C
● Important Biological Agent Technical References	N/A†	Section 18.D
● Non-Contagious Casualty Estimation	Section 5.1.3	Section 18.E
● Contagious Casualty Estimation	Section 5.1.4	Section 18.F
● Equations Needed to Execute Casualty Estimates	Section 5.1.6	Section 18.G
● Anthrax Model	Section 5.2.1	Chapter 19
○ Assumptions and Limitation	Section 5.2.1.2	Section 19.B
○ Human Response Model	Tables 5-6 to 5-8	Section 19.C
○ Cohorts and Special Considerations	Section 5.2.1.3	Section 19.D
● Brucellosis Model	Section 5.2.2	Chapter 20
○ Assumptions and Limitation	Section 5.2.2.2	Section 20.B



<b>Topic</b>	<b>AMedP-7.5</b>	<b>TRM</b>
○ Human Response Model	Tables 5-17 to 5-18	Section 20.C
○ Cohorts and Special Considerations	Section 5.2.2.3	Section 20.D
● Glanders Model	Section 5.2.3	Chapter 21
○ Assumptions and Limitation	Section 5.2.3.2	Section 21.B
○ Human Response Model	Tables 5-28 to 5-29	Section 21.C
○ Cohorts and Special Considerations	Section 5.2.3.3	Section 21.D
● Melioidosis Model	Section 5.2.4	Chapter 22
○ Assumptions and Limitation	Section 5.2.4.2	Section 22.B
○ Human Response Model	Tables 5-40 to 5-41	Section 22.C
○ Cohorts and Special Considerations	Section 5.2.4.3	Section 22.D
● Plague Model	Sections 5.2.5 and 5.2.6	Chapter 23
○ Assumptions and Limitation	Section 5.2.5.2 and 5.2.6.2	Section 23.B
○ Human Response Model	Tables 5-48 to 5-50 and 5-56 to 5-57	Section 23.C
○ Isolation/Quarantine Model Cohorts and Special Considerations	Section 5.2.5.3	Section 23.D
● Q Fever Model	Section 5.2.7	Chapter 24
○ Assumptions and Limitation	Section 5.2.7.2	Section 24.B
○ Human Response Model	Tables 5-59 to 5-61	Section 24.C
○ Cohorts and Special Considerations	Section 5.2.7.3	Section 24.D
● Tularemia Model	Section 5.2.8	Chapter 25
○ Assumptions and Limitation	Section 5.2.8.2	Section 25.B
○ Human Response Model	Tables 5-67 to 5-69	Section 25.C
○ Cohorts and Special Considerations	Section 5.2.8.3	Section 25.D
● Smallpox Model	Sections 5.2.9 and 5.2.10	Chapter 26
○ Assumptions and Limitation	Section 5.2.9.2 and 5.2.10.2	Section 26.B
○ Human Response Model	Tables 5-76 to 5-79 and 5-84 to 5-86	Section 26.C
○ Isolation/Quarantine Model Cohorts and Special Considerations	Section 5.2.9.3	Section 26.D
● EEEV Disease Model	Section 5.2.11	Chapter 27
○ Assumptions and Limitation	Section 5.2.11.2	Section 27.B
○ Human Response Model	Tables 5-87 to 5-88	Section 27.C
○ Cohorts and Special Considerations	Section 5.2.11.3	Section 27.D
● VEEV Disease Model	Section 5.2.12	Chapter 28
○ Assumptions and Limitation	Section 5.2.12.2	Section 28.B
○ Human Response Model	Tables 5-91 to 5-92	Section 28.C
○ Cohorts and Special Considerations	Section 5.2.12.3	Section 28.D
● WEEV Disease Model	Section 5.2.13	Chapter 29
○ Assumptions and Limitation	Section 5.2.13.2	Section 29.B
○ Human Response Model	Tables 5-97 to 5-98	Section 29.C
○ Cohorts and Special Considerations	Section 5.2.13.3	Section 29.D
● Botulism Model	Section 5.2.14	Chapter 30
○ Assumptions and Limitation	Section 5.2.14.2	Section 30.B
○ Human Response Model	Tables 5-104 to 5-106	Section 30.C
○ Cohorts and Special Considerations	Section 5.2.14.3	Section 30.D
● Ricin Intoxication Model	Section 5.2.15	Chapter 31
○ Assumptions and Limitation	Section 5.2.15.2	Section 31.B
○ Human Response Model	Tables 5-121 to 5-122	Section 31.C
○ Cohorts and Special Considerations	Section 5.2.15.3	Section 31.D
● SEB Intoxication Model	Section 5.2.16	Chapter 32

Topic	AMedP-7.5	TRM
○ Assumptions and Limitation	Section 5.2.16.2	Section 32.B
○ Human Response Model	Tables 5-129 to 5-130	Section 32.C
○ Cohorts and Special Considerations	Section 5.2.16.3	Section 32.D
• T-2 Mycotoxigenesis Model	Section 5.2.17	Chapter 33
○ Assumptions and Limitation	Section 5.2.17.2	Section 33.B
○ Human Response Model	Tables 5-135 to 5-136	Section 33.C
○ Cohorts and Special Considerations	Section 5.2.17.3	Section 33.D
• Ebola Virus Disease Information	Section 5.2.18	Chapter 34
Casualty Summation and Reporting	Chapter 6	N/A*

\* The TRM does not discuss this topic because the explanation in AMedP-7.5 was deemed sufficient.

† AMedP-7.5 does not discuss this topic because it is not necessary for the execution of the methodology; the topic is discussed in the TRM to provide supporting background information.

4. Table 1-7 provides some assistance with converting between different measurement units, because AMedP-7.5 uses units that may not be familiar to all readers.<sup>41</sup> Familiarity with metric system units and prefixes is assumed. Note that for biological agents, the conversion between organisms and colony forming units (CFU) or virions and plaque forming units (PFU) is dependent upon too many factors to be standardized—no standard exists.

**Table 1-7: Guide to AMedP-7.5 Measurement Units**

Quantity	AMedP-7.5 Units	Conversion to Other Common Units
Volume	m <sup>3</sup>	1 m <sup>3</sup> = 1000 L
Mass	kg, mg, µg	1 kg = 1000 g = 10 <sup>6</sup> mg = 10 <sup>9</sup> µg = 2.2 lb
Pressure	kPa	101.325 kPa = 1 atm = 14.7 psi
Energy	kJ	4.184 kJ = 1 kcal = 1 Cal
Respiratory Minute Volume	m <sup>3</sup> /min	1 m <sup>3</sup> /min = 1000 L/min
Radioactivity	TBq	0.037 TBq = 1 Ci*
Absorbed Radiation Dose	Gy	1 Gy = 100 rad*
Equivalent Radiation Dose	Sv	1 Sv = 100 rem*
Effective Radiation Dose	Sv	1 Sv = 100 rem*

\* “Ci” = Curie; “rem” = roentgen equivalent man; “rad” is not an abbreviation.

<sup>41</sup> See [https://en.wikipedia.org/wiki/Conversion\\_of\\_units](https://en.wikipedia.org/wiki/Conversion_of_units) for a comprehensive list of unit conversions.

## CHAPTER 2 USER INPUT

This chapter fully describes each required and optional user input—it discusses the INPUT step of the methodology. It includes example input tables, default parameter values, and guidance to the user. A final aspect of user input, not discussed any further in this chapter, is that the user may edit any parameter value in the methodology. All given parameter values should be considered the default or recommended value, but users who wish to change values may do so. However, users must be cautious to use realistic parameter values, or odd results may occur.

### 2.1. ICONS AND ICON ATTRIBUTES

1. An icon is a group of individuals sharing a common location over time. For example, four people in a tank or a grouping of personnel in a fighting position. Each icon is assigned a unique numerical identifier called the icon index ( $n$ ).
2. When defining icons, the user must determine the appropriate way to group individuals. For example, a cluster of individuals within a 10 km<sup>2</sup> area may be represented by a single icon or by multiple icons. When considering scenarios covering several hundred square kilometers in area, users may wish to choose a lower spatial resolution—where each icon covers a larger geographic area—than when considering scenarios covering only a few square kilometers.
3. The user's grouping of individuals into icons is external to the methodology. The input required by the methodology is described below in terms of icon attributes.

#### 2.1.1. Overview of Icon Attributes

1. The user must provide the number of personnel in each icon.
2. The user may provide identifying information to assist in interpreting results, such as battalion, company, platoon, and area. This information is not used by the methodology.
3. The user must provide CBRN Challenge data (Input Scheme 1) or the Effective CBRN Challenge (Input Scheme 2). These inputs must be derived from the user's national hazard prediction model, which is separate from AMedP-7.5.
4. If the user provides CBRN Challenge (Input Scheme 1), then it is strongly recommended that the user also define challenge-modifying attributes to match the planning scenario; otherwise, default values will be used. Table 2-1 summarizes the attributes, including default values, and identifies which attributes are considered when estimating an icon's Effective CBRN Challenge, as a function of the challenge type. The values of challenge-modifying icon attributes may change over time, as specified by the user.

**Table 2-1: Challenge-Modifying Icon Attributes**

Challenge Type	Attributes and Potential Methodological Relevance					
	Minute Volume	Body Surface Area	IPE	Vehicle or Shelter*	Pre-exposure Prophylaxis	Uniform
Chemical inhalation	X		X	X	X	
Chemical perc. vapour			X	X	X	
Chemical perc. liquid		X	X	X	X	
Biological inhalation	X		X	X	†	
Gamma radiation	X‡		X‡	X		
Neutron radiation	X‡		X‡	X		
Beta radiation	X‡		X‡	X		
Blast (nuclear)				X		
Thermal (nuclear)				X		X
Default Values for All Challenge Types§						
	0.015 m <sup>3</sup> /min	0.9 m <sup>2</sup>	None	None	None	Battledress Uniform (BDU) + T-shirt

\* Relates to physical protection and ColPro.

† Note that prophylaxis for biological agents is accounted for separately; see Section 5.1.

§ Used if the user does not specify alternate values.

‡ Only used for calculating inhaled dose.

‡ Used for both inhaled dose and cutaneous dose calculations.

5. If the user provides the Effective CBRN Challenge (Input Scheme 2), then the methodology will not use the challenge-modifying attributes.

6. The use of icons and icon attributes supports several important features.

a. Using icons supports the application of spatially resolved output from national hazard prediction models, despite icon location not being an input for this methodology.

b. Using icon attributes allows the user to account for a postulated distribution of defensive postures across the PAR.

c. The ability to change the values of icon attributes over time allows the user to account for warning and response, which is the combined process of gathering information indicating that a CBRN incident has occurred, assessing that information to determine its meaning and implications, and deciding upon an appropriate tactical response. Examples of tactical responses the icon attributes might account for are:

1) A command decision that all personnel must wear certain IPE because of the assessed threat.

2) Donning IPE or taking shelter in response to observing nerve agent poisoning symptoms in some personnel.

3) Donning IPE or taking shelter in response to a detector alarm.

### 2.1.2. CBRN Challenge or Effective CBRN Challenge

1. The user may supply CBRN Challenge information via one of two input schemes (summarized in the INPUT box in Figure 1-3). The choice of input scheme should be determined by whether the user is able to provide input for the challenge-modifying icon attributes. As more input is provided, the resulting casualty estimate will better match the planning scenario. For either input scheme, the CBRN challenge data must be generated using *national tools*—there is no NATO standardized method of generating CBRN challenge estimates (ATP-45<sup>42</sup> predicts hazard *areas*, but not hazard *magnitudes*).

2. CBRN Challenge (Input Scheme 1).

- a. The user must provide data for each icon at each time point. Note, however, that if desired, a user may choose to provide data at only one time point (the end of the challenge).
- b. The final time point should be the time past which the CBRN Challenge no longer increases—that is, the provided input should encompass the entire period over which icons are challenged.
- c. Time must be specified in units of minutes. The total duration, number of time points, and intervals between time points are user-specified. A varying time interval is allowed, but the time intervals must be the same for all icons. Likewise, “time zero” must be the same for all icons.
- d. The user should ensure that the national tool used to generate the challenge data has time resolution sufficient to capture the fidelity of icon movement<sup>43</sup> and defensive action the user desires to model. For example, if the user wishes to capture the ability of individuals to don a mask in 15 seconds, the time interval around the time when individuals don masks should be 15 seconds (0.25 minutes) or shorter. If icons are not moving or taking any defensive actions and the hazard changes slowly, a time interval of up to 5 minutes is acceptable. If the user is unsure of what time resolution to use, 1 minute is a reasonable default.
- e. For all challenge types other than chemical agent peak concentration, the data must be cumulative, not instantaneous. Cumulative relates to the area under the curve of a plot of challenge versus time, whereas instantaneous relates to the specific magnitude of the challenge at a given time. If the user’s national hazard prediction model only outputs instantaneous data, the user must use a numerical integration technique<sup>44</sup> to generate the cumulative input data

---

<sup>42</sup> NATO, ATP-45(E).

<sup>43</sup> Note that although the methodology does not use icon locations, icon movement could be reflected by changes in the values of challenge-modifying icon attributes.

<sup>44</sup> For example, Simpson’s rule (see [http://en.wikipedia.org/wiki/Simpson%27s\\_rule](http://en.wikipedia.org/wiki/Simpson%27s_rule)).

required by the methodology. As specified in Section 1.4.3.b., chemical agent peak concentration challenge data should be instantaneous.

3. Effective CBRN Challenge (Input Scheme 2).
  - a. The user must provide a single value for each icon.
  - b. The methodology will not modify the user-provided values. Thus, the user must already have accounted for the challenge-modifying icon attributes.
4. The input must be provided in the units specified in Table 2-2. If Input Scheme 1 is used, the methodology will calculate the Effective CBRN Challenge in the appropriate units.

**Table 2-2: Challenge Types and Associated Units for CBRN Challenges**

Agent or Effect Challenge Type (Subcomponents, if any)	Symbol (Q)	CBRN Challenge (Input Scheme 1)	Effective CBRN Challenge (Input Scheme 2)
GA Inhaled GA	GA,ih	mg-min/m <sup>3</sup>	mg-min/m <sup>3</sup>
GB Inhaled GB	GB,ih	mg-min/m <sup>3</sup>	mg-min/m <sup>3</sup>
GD Inhaled GD	GD,ih	mg-min/m <sup>3</sup>	mg-min/m <sup>3</sup>
GF Inhaled GF	GF,ih	mg-min/m <sup>3</sup>	mg-min/m <sup>3</sup>
VX Inhaled VX Percutaneous VX Liquid	VX,ih VX,pc	mg-min/m <sup>3</sup> mg/m <sup>2</sup>	mg-min/m <sup>3</sup> mg
HD Inhaled HD Ocular HD (Percutaneous Vapour) Equivalent Percutaneous HD (Percutaneous Vapour) (Percutaneous Liquid)	HD,ih HD,oc HD,pv HD,epc HD,pv HD,pl	mg-min/m <sup>3</sup>  mg-min/m <sup>3</sup>  mg-min/m <sup>3</sup> mg/m <sup>2</sup>	mg-min/m <sup>3</sup> mg-min/m <sup>3</sup>  mg-min/m <sup>3</sup>
CG Inhaled CG Peak CG Concentration	CG,ih CG,[ih]	mg-min/m <sup>3</sup> mg/m <sup>3</sup>	mg-min/m <sup>3</sup> mg/m <sup>3</sup>
Cl <sub>2</sub> Inhaled Cl <sub>2</sub>	Cl2,ih	mg-min/m <sup>3</sup>	mg-min/m <sup>3</sup>
NH <sub>3</sub> Inhaled NH <sub>3</sub>	NH3,ih	mg-min/m <sup>3</sup>	mg-min/m <sup>3</sup>
AC Inhaled AC	AC,ih	mg-min/m <sup>3</sup>	mg-min/m <sup>3</sup>
CK Inhaled CK Peak CK Concentration	CK,ih CK,[ih]	mg-min/m <sup>3</sup> mg/m <sup>3</sup>	mg-min/m <sup>3</sup> mg/m <sup>3</sup>
H <sub>2</sub> S Inhaled H <sub>2</sub> S	H2S,ih	mg-min/m <sup>3</sup>	mg-min/m <sup>3</sup>

Agent or Effect Challenge Type (Subcomponents, if any)	Symbol (Q)	CBRN Challenge (Input Scheme 1)	Effective CBRN Challenge (Input Scheme 2)
RDD Cutaneous Radiation (Skin Contamination) (Cloudshine) (Groundshine) Whole-Body Radiation (Cloudshine) (Groundshine) (Inhalation)	RDD,cut RDD,cut,s RDD,cut,cld RDD,cut,grd RDD,wb RDD,wb,cld RDD,wb,grd RDD,wb,ih	TBq/m <sup>2</sup> TBq-hr/m <sup>3</sup> TBq-hr/m <sup>2</sup> TBq-hr/m <sup>3</sup> TBq-hr/m <sup>2</sup> TBq-min/m <sup>3</sup>	Gy   Gy
Fallout Cutaneous Radiation (Skin Contamination) (Groundshine Gamma) (Groundshine Beta) Whole-Body Radiation (Groundshine)	FO,cut FO,cut,s FO,cut,grd-γ FO,cut,grd-β FO,wb FO,wb,grd	TBq-hr/m <sup>2</sup> Gy Gy Gy	Gy   Gy
Nuclear Detonation Whole-Body Radiation (Neutron) (Gamma) Blast Static Overpressure Thermal Fluence	nuc,wb nuc,wb,n <sup>0</sup> nuc,wb,γ nuc,blast nuc,thermal	Gy Gy kPa kJ/m <sup>2</sup>	Gy   kPa %BSA
Anthrax Inhaled <i>B. anthracis</i>	anth	spore-min/m <sup>3</sup>	spore
Brucellosis Inhaled <i>Brucella</i>	bruc	CFU-min/m <sup>3</sup>	CFU
Glanders Inhaled <i>B. mallei</i>	glan	organism-min/m <sup>3</sup>	organism
Melioidosis Inhaled <i>B. pseudomallei</i>	meli	CFU-min/m <sup>3</sup>	CFU
Plague Inhaled <i>Y. pestis</i>	plag	CFU-min/m <sup>3</sup>	CFU
Q fever Inhaled <i>C. burnetii</i>	Qfvr	organism-min/m <sup>3</sup>	organism
Tularemia Inhaled <i>F. tularensis</i>	tul	organism-min/m <sup>3</sup>	organism
Smallpox Inhaled <i>V. major</i>	spox	PFU-min/m <sup>3</sup>	PFU
EEEV Disease Inhaled EEEV	EEEVD	PFU-min/m <sup>3</sup>	PFU
VEEV Disease Inhaled VEEV	VEEVD	PFU-min/m <sup>3</sup>	PFU
WEEV Disease Inhaled WEEV	WEEVD	PFU-min/m <sup>3</sup>	PFU
Botulism Inhaled Botulinum neurotoxin	bot	μg-min/m <sup>3</sup>	μg
Ricin Inhaled Ricin	ricin	μg-min/m <sup>3</sup>	μg
Staphylococcal enterotoxin B (SEB) Inhaled SEB	SEB	μg-min/m <sup>3</sup>	μg
T-2 Mycotoxin Inhaled T-2 Mycotoxin	T-2	mg-min/m <sup>3</sup>	mg

Note: for assistance converting measurement units, see Table 1-7.

### 2.1.3. Respiratory Minute Volume

1. For inhaled chemical agent, inhaled biological agent, and inhaled radiological particle (contributes to whole-body dose for RDD) challenges, the respiratory minute volume (usually referred to simply as minute volume) is used in the calculation of the inhaled<sup>45</sup> concentration time (chemical), dose (biological), or dose equivalent (radiological particles).
2. The user may specify either the qualitative level of activity—which will be converted to a minute volume according to Table 2-3—or a specific minute volume in units of m<sup>3</sup>/min. If no input is provided, the default values in Table 2-3 will be used.
3. The chemical agent human response models have a built-in assumption of a 0.015 m<sup>3</sup>/min (15 L/min) minute volume. Thus, minute volume is not used directly; a unitless factor defined as the minute volume divided by 0.015 m<sup>3</sup>/min is used.
4. The biological agent and RDD human response models *do not* have a built-in minute volume assumption, so minute volume in units of m<sup>3</sup>/min is used.
5. Table 2-3 specifies the default and suggested alternate values for the minute volume. The user may specify any desired minute volume.

---

<sup>45</sup> The fraction of inhaled agent that is retained is irrelevant because the underlying models are based on the amount of inhaled agent.



**Table 2-3: Suggested and Default Respiratory Minute Volume**

Challenge Type	Optional Input		
	Activity Level	Minute Volume [m <sup>3</sup> /min] <sup>†</sup>	Unitless Factor <sup>§</sup>
Chemical Agent Inhalation	At Rest	0.0075	0.5
	Light ( <i>default</i> )	0.0150 ( <i>default</i> )	1 ( <i>default</i> )
	Moderate	0.0300	2
	Heavy	0.0750	5
Biological Agent and Radiological Particle Inhalation	At Rest	0.0075	N/A
	Light ( <i>default</i> )	0.0150 ( <i>default</i> )	N/A
	Moderate	0.0300	N/A
	Heavy	0.0750	N/A

Note: Activity level, Minute Volume, and Unitless factor are all linked; if the user specifies a value, specifying the value for one column fixes the choice for the other two columns.

\* Multiply minute volume in m<sup>3</sup>/min by 1000 to convert to L/min.

† Derived from David W. Layton, "Metabolically Consistent Breathing Rates for Use in Dose Assessments," *Health Physics* 64, no. 1 (1993): 23–36.

§ The unitless factor is calculated by dividing the actual minute volume by 0.015 m<sup>3</sup>/min.

#### 2.1.4. Body Surface Area

1. For liquid chemical agent challenges, the total body surface area challenged is used in the calculation of the dose.
2. The standard man is typically assumed to have 1.8 m<sup>2</sup> of body surface area. As most hazard prediction models do not have the fidelity to determine the orientation of personnel relative to the challenge, the default and recommended value is 0.9 m<sup>2</sup>, representing half of a person's body surface area.
3. Users may provide a different value, but must be careful not to change the body surface area in an attempt to account for IPE; other icon attributes account for those effects.

#### 2.1.5. Individual Protective Equipment (IPE)

1. IPE may provide protection against chemical, biological, and radiological particle inhalation, chemical vapour and liquid percutaneous, and beta radiation challenges.
2. These protective effects are modeled using pre-determined protection factors. Table 2-4 lists suggested values. The symbol used in this document for protection factors from IPE follows the format PF<sub>IPE,Q,n</sub>, where Q is the challenge type and *n* is the icon number.
3. IPE, clothing, and even regular combat uniforms may also provide some protection against thermal challenges, but these protective effects are incorporated into the thermal fluence thresholds listed in Table 4-59 (Section 4.4.4), so protection factors are not used.

Table 2-4: Suggested IPE Protection Factors

Optional Input					
Item		Protection Factors			
IPE Class	Example	Inhalation (PF <sub>IPE,ih,n</sub> )	Perc. Vapour (PF <sub>IPE,pv,n</sub> )	Perc. Liquid (PF <sub>IPE,pl,n</sub> )	Beta Radiation* (PF <sub>IPE,β,n</sub> )
None	Combat uniform	1	1	1	1
Mask only	M40, M50	100,000	1.05	1.05	1
Suit and boots	MOPP II	1	9.1	9.1	1
Suit, boots, and mask	MOPP III	100,000	15.4	15.4	15.4
Full protection	MOPP IV	100,000	∞	∞ <sup>†</sup>	∞

\* In this methodology, beta radiation can come from fallout or certain types of RDD.

† Such equipment is typically designed for a 10 g/m<sup>2</sup> challenge. Although the protection is not truly infinite, a protection factor of ∞ may be used for all practical purposes.

### 2.1.6. Vehicles and Shelters (Physical Protection and ColPro)

1. Vehicles and shelters may provide protection against all challenge types. The degree of protection provided generally depends on the type of shelter or vehicle.

2. These protective effects are modeled using protection factors for all challenges except thermal fluence. See Table 2-6 through Table 2-8 for suggested values. The symbol used in this document for protection factors from vehicles and shelters follows the format PF<sub>V-SH,Q,n</sub>.

- a. Vehicles and shelters are assumed to completely protect icons from liquid chemical agent challenges.
- b. Inhalation and percutaneous vapour protection afforded by vehicles and shelters *with* ColPro is modeled using pre-determined protection factors.
- c. Inhalation and percutaneous vapour protection afforded by vehicles and shelters *without* ColPro is modeled using protection factors that must be estimated on a per-icon and per-challenge basis using Equation 2-1, which depends upon the air exchange rate, the duration of occupancy, and the duration the vehicle or shelter is enveloped in the cloud.<sup>46</sup> The maximum calculated PF occurs when Occupancy<sub>n</sub> = Duration<sub>n</sub>, and the PF decreases as Occupancy<sub>n</sub> increases beyond Duration<sub>n</sub>.

$$PF_{V-SH,ih/pv,n} = \frac{AER_n \cdot Duration_n}{AER_n \cdot Duration_n + e^{(-AER_n \cdot Occupancy_n)} - e^{AER_n \cdot (Duration_n - Occupancy_n)}}, \quad (2-1)$$

where:

<sup>46</sup> William K. Blewett et al., *Expedient Sheltering in Place: An Evaluation for the Chemical Stockpile Emergency Preparedness Program* (Aberdeen Proving Ground, MD: Edgewood Research Development and Engineering Center, June 1996), 14–20.

$PF_{V-SH,ih/pv,n}$  is the protection factor for icon  $n$  for the duration of Occupancy $_n$ ,

AER $_n$  is the air exchange rate at icon  $n$  [air changes per hour (ACH)]—Table 2-5 provides suggested air exchange rates for various vehicles and shelters,

Duration $_n$  is the length of time the cloud envelopes the vehicle/structure while it is occupied by icon  $n$  [hr], and

Occupancy $_n$  is the length of time of vehicle/structure occupancy from the time of cloud arrival at icon  $n$  [hr], which must be greater than or equal to Duration $_n$ .

Note for Input Scheme 1: if an icon leaves the vehicle or shelter while it is still enveloped, Duration $_n$  and Occupancy $_n$  must be set equal to avoid negative numbers. Accordingly, the resulting protection factor must only be applied to the time steps during which the icon occupied the vehicle or shelter.

**Table 2-5: Suggested Air Exchange Rates for Vehicles and Shelters Without ColPro**

Optional Input		
Vehicle or Shelter Ventilation Class	Examples	AER $_n$ [ACH]
Residential Building – Closed Windows	Barracks	0.5
Nonresidential Building – Closed Windows	Administrative, Control and Work Buildings	1.3
Residential Building – Open Windows	Hangar	6.4
Stationary Vehicle – Open Windows, No Ventilation	Chem-Bio Protective System (CBPS), Tent <sup>†</sup> , Tactical Operations Center (TOC)	20
Stationary Vehicle – Closed Windows, Fan on Recirculation	Self-Propelled Howitzer, Truck/Van, Recovery	2.5
Stationary Vehicle – Closed Windows, No Ventilation		2
Moving Vehicle – Closed Windows	Armored Engineer Vehicle (AEV), Armored Personnel Carrier (APC)	36
Stationary Vehicle – Open Windows, Fan on Fresh Air	Truck/Van	40

\* Adapted from J. H. Park et al., "Measurement of Air Exchange Rate of Stationary Vehicles and Estimation of in-Vehicle Exposure," *Journal of Exposure Analysis and Environmental Epidemiology* 8, no. 1 (1998): 65–78 and Ted Johnson, *A Guide to Selected Algorithms, Distributions, and Databases Used in Exposure Models Developed by the Office of Air Quality Planning and Standards* (Chapel Hill, NC: TRJ Environmental, Inc., 2002).

† Tents are assumed to have an ACH of 20, the same as a stationary vehicle with windows open and no ventilation.

**Table 2-6: Suggested Inhalation and Percutaneous Protection Factors for Vehicles and Shelters**

Optional Input				
Vehicle or Shelter Ventilation Class	Example	Inhalation (PF <sub>V-SH,ih,n</sub> )	Perc. Vapour (PF <sub>V-SH,pv,n</sub> )	Perc. Liquid (PF <sub>V-SH,pl,n</sub> )
None	Dismounted, Foxhole	1	1	1
Vehicle w/ColPro	CBPS, TOC, Recovery, Self-Propelled Howitzer, AEV, APC	3000	3000	∞
Vehicle w/o ColPro	Mortar, Mobile Surface-to-Air Missile Launcher, Tent, Truck/Van	Use Equation 2-1		∞
Shelter w/ColPro	Admin Building, Control Building, ColPro Barracks	3000	3000	∞
Shelter w/o ColPro	Barracks, Hangar, Work Building	Use Equation 2-1		∞

- d. Radiation and blast shielding afforded by vehicles and shelters are modeled using pre-determined protection factors. Suggested protection factors are listed in Table 2-7 and Table 2-8. Note that the level of protection each vehicle or shelter provides is typically different for neutron and gamma radiation. Further, all vehicles and shelters are assumed to provide complete protection from beta radiation, so the suggested protection factor is ∞. Finally, the inhalation protection provided against radiological particles should be based on the previous discussion of inhalation protection.

**Table 2-7: Suggested Radiation Shielding Protection Factors for Vehicles and Shelters**

Optional Input		
Vehicle or Shelter Radiation Class	Neutron Radiation (PF <sub>V-SH,n<sup>0</sup>,n</sub> )	Gamma Radiation (PF <sub>V-SH,γ,n</sub> )
Armored Personnel Carrier	1.22	2.70
Earth Shelter	16.67	66.67
Exposed/Dismounted	1.00	1.00
Foxhole (nuclear only) <sup>†</sup>	3.00	10.00
Masonry Building	8.33	6.67
Multi-Story Brick Building	1.33	1.56
Tank	3.57	10.00
Tent	1.00	1.00
Truck	1.00	1.25
Van	1.05	1.05
Wood Frame Building	1.39	1.22

\* The values in this table are of the approximate range, but not exactly equal to “correct” values. “Correct” values tend to have limited distribution or be classified. Users are encouraged to use other values based on operational test data, as available, or other NATO sources such as AEP-4<sup>47</sup>

<sup>47</sup> North Atlantic Treaty Organization (NATO), *AEP-4: Nuclear Survivability Criteria for Armed Forces Material and Installations*, STANAG 4145 (Brussels, Belgium: NATO, September 1996). NATO

and ATP-45.<sup>48</sup> Values from these documents are not included here because of classification and distribution limitations.

† For RDD and fallout challenges, foxholes should be modeled with protection factors of 1.

**Table 2-8: Suggested Blast Shielding Protection Factors**

Vehicle/Shelter Blast Class	Optional Input
	Blast Shielding Protection Factor* (PF <sub>V-SH,blast,n</sub> )
All	1

\* No generally accepted blast shielding protection factors were available; this table is a placeholder. Users may input specific national data, if desired.

3. The protection vehicles and shelters provide from thermal fluence is not modeled using protection factors because the equation used to estimate thermal insults is not applicable to partially protected bodies. For details on how it is included in the human response estimates, see Section 4.4.4.

**2.1.7. Pre-Exposure Prophylaxis**

1. In general, pre-exposure prophylaxis might provide protection against any challenge type.

2. No currently fielded prophylaxis options are modeled using protection factors, so Table 2-9 is a placeholder to help illustrate how the methodology would incorporate prophylaxis, pending future development of relevant prophylaxis. The symbol used in this document for protection factors from pre-exposure prophylaxis follows the format PF<sub>proph,Q,n</sub>, where Q is the challenge type.

**Table 2-9: Suggested Protection Factors for CRN Prophylaxis**

Specific Prophylaxis	Optional Input	
	Challenge Type(s) For Which the Prophylaxis is Effective	Prophylaxis Protection Factor* (PF <sub>proph,Q,n</sub> )
None	All	1

\* No relevant prophylaxis is currently fielded; this table is a placeholder for future capabilities. Users may input specific national data, if desired.

3. Note that although vaccination and/or chemoprophylaxis are available for many biological agents, the protective effects are not modeled using a protection factor—see Section 5.2 for details on how each biological agent prophylaxis option is used in the human response estimate.

**2.1.8. Uniform**

Uniforms may provide some protection against thermal challenges, but these protective effects are incorporated into the thermal fluence thresholds listed in Table 4-59 (Section 4.4.4), so protection factors are not used.

CONFIDENTIAL.

<sup>48</sup> NATO, ATP-45(E), 6-34 and Table 6-8.

### 2.1.9. Aggregate Protection Factor

1. The protection factors associated with the IPE, vehicle or shelter, and pre-exposure prophylaxis attributes are used in Equation 2-2 to calculate an icon's Aggregate Protection Factor (APF), which is used in the equations in Chapter 3 during the calculation of an icon's Effective CBRN Challenge.

$$APF_{Q,n} = PF_{IPE,Q,n} \cdot PF_{V-SH,Q,n} \cdot PF_{proph,Q,n}, \tag{2-2}$$

where:

$APF_{Q,n}$  is icon  $n$ 's APF for challenge type  $Q$ ,

$PF_{IPE,Q,n}$  is the protection factor for challenge type  $Q$  from all IPE used by icon  $n$ ,

$PF_{V-SH,Q,n}$  is the protection factor for challenge type  $Q$  from the vehicle or shelter occupied by icon  $n$  (accounts for physical protection and ColPro), and

$PF_{proph,Q,n}$  is the protection factor for challenge type  $Q$  from any pre-exposure prophylaxis used by icon  $n$ .

2. If the user does not provide input for a particular protection factor, the default value of 1 is used. Thus, if the user provides no input for any protection factor, the  $APF = 1$ —no protection is modeled.

### 2.1.10. Example Input and Comparison of Input Schemes

1. Table 2-10 is an example of icon definitions including identifying information.

**Table 2-10: Example Definition of Icons**

Required Input		Optional Input			
Icon Index	# of Individuals	Battalion	Company	Platoon	Area
1	4	Abn Inf Bn (+)	1-A Rifle Co	1-A-HQ	1-A Co Area
2	4	Abn Inf Bn (+)	1-B Rifle Co	1-B-HQ	1-B Co Area
3	1	Abn Inf Bn (+)	HHC		1 Bn HQ
4	4	Abn Inf Bn (+)	1-C Rifle Co	1-C-HQ	1-C Co Area
5	1	Abn Inf Bn (+)	HHC		1 Bn HQ
6	7	Abn Inf Bn (+)	1-A Rifle Co	1-A-1-1	1-A Co Area

2. Table 2-11 is an example of Input Scheme 1 input for the first five icons from Table 2-10, for a notional GB incident. Data for the CBRN Challenge and various icon attributes are listed.

3. Table 2-11 shows that after the incident begins, icons 1, 2, and 4 don masks, and icons 1 and 4 also change activity levels; protection factors and minute volume change accordingly. Input Scheme 1 is able to capture those changes.

4. A user modeling the same scenario using both Input Scheme 2 would be forced to answer the following regarding the input to provide for icons 1, 2, and 4.
- Should icons 1, 2, and 4 be modeled as having the protection factor associated with masks, or not?
  - Which minute volume should be used for icons 1 and 4?
5. Table 2-12 is an example of Input Scheme 2 input for the same five icons and notional GB incident, based on the following answers to the questions posed above.
- Icon 1 should be modeled with 0.015 m<sup>3</sup>/min, and icon 4 should be modeled with 0.030 m<sup>3</sup>/min.
  - Choice 1: icons 1, 2, and 4 should be modeled using the mask protection factor.
  - Choice 2: icons 1, 2, and 4 should *not* be modeled using the mask protection factor.
6. Table 2-13 shows how the Effective CBRN Challenge as calculated by Input Scheme 1 differs from either set of Input Scheme 2 inputs. In each case, the incident scenario is the same, but because Input Scheme 1 uses time-resolved icon attributes, its Effective CBRN Challenge reflects that nobody was wearing IPE when the incident began, but several icons donned masks quickly, and the minute volume for several icons also changed as they reacted to the incident. The results for Input Scheme 2 reflect different user assumptions about minute volume and use of IPE, but neither case matches well with the result from Input Scheme 1.
7. Even without the details of how the Effective CBRN Challenge is used to estimate casualties, it is clear from Table 2-13 that three different ways of representing the same incident scenario can result in different casualty estimates.<sup>49</sup> In general, Input Scheme 1 better reflects operational reality—personnel will react to a CBRN incident; the user should use Input Scheme 1 whenever possible.

**Table 2-11: Example Input for Input Scheme 1, for a Notional GB Incident**

Required Input			Optional Input			
Icon Index	Time [min]	Concentration-time [mg-min/m <sup>3</sup> ]	Activity Level <sup>†</sup>	IPE Class <sup>†</sup>	Vehicle or Shelter Class <sup>†</sup>	Prophylaxis <sup>†</sup>
1	0	0	At Rest	None	None	None
1	1	15.0	Moderate	Mask	None	None
1	4	38.4	Light	Mask	None	None

<sup>49</sup> For the curious reader, the best example of the difference is icon 4: under Input Scheme 1, icon 4 would become WIA and eventually RTD; under Input Scheme 2 (Choice 1), icon 4 would not become casualties; under Input Scheme 2 (Choice 2), icon 4 would become KIA if untreated, or WIA and eventually permanently CONV if treated.

Required Input			Optional Input			
Icon Index	Time [min]	Concentration-time [mg-min/m <sup>3</sup> ]	Activity Level <sup>†</sup>	IPE Class <sup>†</sup>	Vehicle or Shelter Class <sup>†</sup>	Prophylaxis <sup>†</sup>
1	8	52.0	Light	Mask	None	None
1	10	55.0	Light	Mask	None	None
2	0	0	Light	None	None	None
2	1	60.2	Light	Mask	None	None
2	4	192.8	Light	Mask	None	None
2	8	312.0	Light	Mask	None	None
2	10	345.4	Light	Mask	None	None
3	0	0	At Rest	None	Shelter w/ColPro	None
3	1	0	At Rest	None	Shelter w/ColPro	None
3	4	0	At Rest	None	Shelter w/ColPro	None
3	8	0	At Rest	None	Shelter w/ColPro	None
3	10	0	At Rest	None	Shelter w/ColPro	None
4	0	0	At Rest	None	None	None
4	1	18.8	Moderate	None	None	None
4	4	23.8	Heavy	Mask	None	None
4	8	23.8	Heavy	Mask	None	None
4	10	23.8	Heavy	Mask	None	None
5	0	0	At Rest	None	Shelter w/ColPro	None
5	1	0	At Rest	None	Shelter w/ColPro	None
5	4	7.8	At Rest	None	Shelter w/ColPro	None
5	8	35.0	At Rest	None	Shelter w/ColPro	None
5	10	42.8	At Rest	None	Shelter w/ColPro	None

\* Instead of activity level, a user could provide a specific minute volume —see Table 2-3.

† Instead of these general descriptors, a user could provide a specific protection factor for each icon attribute (see Table 2-4 through Table 2-9).

**Table 2-12: Example Input for Input Scheme 2, for a Notional GB Incident**

Required Input		
Icon Index	Inhaled Concentration Time [mg-min/m <sup>3</sup> ]	
	Choice 1	Choice 2
1	0.03	55.00
2	0.21	345.40
3	0.00	0.00
4	0.03	47.60
5	0.01	0.01

Note: recall from paragraph 1.5.3 that “inhaled” does not imply retained or absorbed dose.



**Table 2-13: Example Differences in Effective CBRN Challenge Resulting from Using Different Input Schemes for the Same Notional GB Incident**

	Input Scheme 1	Input Scheme 2—Choice 1	Input Scheme 2—Choice 2
Icon Index	Inhaled Concentration Time [mg-min/m <sup>3</sup> ]	Inhaled Concentration Time [mg-min/m <sup>3</sup> ]	Inhaled Concentration Time [mg-min/m <sup>3</sup> ]
1	7.54	0.03	55.00
2	60.4	0.21	345.40
3	0.00	0.00	0.00
4	9.41	0.03	47.60
5	0.01	0.01	0.01

Note: recall from paragraph 1.5.3 that “inhaled” does not imply retained or absorbed dose.

## 2.2 METHODOLOGY PARAMETERS

1. For each parameter below, the user may specify a value. If no value is specified, the default defined in Table 2-14 will be used.
2. Medical Treatment Flag (Flag<sub>MT</sub>). A binary parameter that determines whether the effects of medical treatment are modeled. If set to NO, the “Untreated” models are used; in general, these models reflect no medical treatment.<sup>50</sup> If set to YES, the “Treated” human response models are used; these models are intended to reflect all available medical treatment. The default value is YES.
3. Time at Injury Severity Level 4 sufficient to cause death from untreated chemical, nuclear blast, or nuclear burn injuries (T<sub>death-CN-SL4</sub>). Untreated<sup>51</sup> casualties with a chemical, nuclear blast, or nuclear burn injury that spend this amount of time at Severity Level 4 are assumed to die. The default value is 15 minutes.
  - a. When Flag<sub>MT</sub> = Yes (the default value), all such casualties are KIA, because once a casualty reaches a MTF, medical treatment models are used to determine the outcome.
  - b. When Flag<sub>MT</sub> = No, all casualties follow this assumption, even after reaching a MTF. Thus, KIA and DOW casualties may be a result of extended periods of Injury Severity Level 4.
4. Time to reach a medical treatment facility (T<sub>MTF</sub>). The time required for an individual who is WIA to reach a MTF. Given the definitions of KIA and DOW, T<sub>MTF</sub> determines whether a WIA who dies is KIA or DOW (see Figure 1-2). The default value is 30 minutes, and a user can specify any value up to (but excluding) 1 day—the methodology is built around the assumption that casualties reach an MTF *within* one day of becoming WIA.

<sup>50</sup> Models derived from animal data truly reflect no medical treatment. However, some of the biological agent models are derived from human data and include the effects of supportive care.

<sup>51</sup> Including *not yet treated* casualties en route to a MTF.

5. The casualty criterion. The user-specifiable injury severity threshold above which an individual is declared WIA. The user may choose between WIA(1+), WIA(2+), and WIA(3+). WIA(1+) will typically result in individuals being declared casualties and then reporting to the medical system sooner than would WIA(2+) or WIA(3+) (see Figure 1-1). Methodologically, reporting to the medical system for injuries of lower severity results in fewer deaths and more personnel in the medical system (individuals are less likely to die before reaching an MTF). The default value is WIA(1+).

6. The day on which antibiotic or antitoxin treatment begins ( $d_{\text{trt-Q}}$ ). For some bacterial diseases and for botulism, an individual's prognosis and/or duration of illness depend upon when treatment with antibiotic or antitoxin begins. The methodology default value is day 1, which is likely to be optimistic. It is recommended that the user specify values based the following considerations, three of which are operation-specific.

- a. The difficulty of differential diagnosis of the disease in the absence of specific intelligence information.
- b. Anticipated intelligence regarding enemy capabilities and intentions, which might raise a doctor's index of suspicion, facilitating quicker diagnosis.
- c. Anticipated real-time or near-real-time detection of the attack.
- d. Logistics delays, if a specialized treatment is required but not stocked locally.

**Table 2-14: Default Values for Methodology Parameters**

Parameter	Default
Time to Reach a Medical Treatment Facility ( $T_{\text{MTF}}$ )	30 minutes
Time at Severity Level 4 Sufficient to Cause Death From Chemical, Nuclear Blast, or Nuclear Burn Injuries ( $T_{\text{death-CN-SL4}}$ )	15 minutes
Medical Treatment Flag ( $\text{Flag}_{\text{MT}}$ )	Yes
Casualty Criterion	WIA(1+)
The day on which antibiotic or antitoxin treatment begins ( $d_{\text{trt-Q}}$ )	Day 1

**CHAPTER 3 EFFECTIVE CBRN CHALLENGE ESTIMATION**

This chapter provides the general framework for calculating the Effective CBRN Challenge from the inputs described in Chapter 2—it discusses the CHALLENGE step of the methodology. Special considerations for certain challenge types are fully described in Chapter 4, Sections 4.2 through 4.4. The CBRN Challenge inputs needed for the equations in this chapter ( $X_{Q,n,t_k}$ ) must be derived from the user's national hazard prediction model.

### 3.1. INPUT SCHEME 1

1. For each challenge type other than inhaled chemical agent peak concentration, each icon's Effective CBRN Challenge is estimated using Equation 3-1, which incrementally sums (over time) the portion of the CBRN Challenge that becomes the Effective CBRN Challenge. The difference term in parentheses calculates the incremental CBRN Challenge during the timestep from  $t_k$  to  $t_{k-1}$ , and  $Z$  and  $APF_{Q,n,t_{k-1}}$  convert the incremental CBRN Challenge into the incremental Effective CBRN Challenge. See Table 2-11 for an example of input that could be used with Equation 3-1.

$$X_{Q,n}^{\text{eff}} = \sum_{k=1}^f \frac{(X_{Q,n,t_k} - X_{Q,n,t_{k-1}}) \cdot Z}{APF_{Q,n,t_{k-1}}}, \quad (3-1)$$

where:

$X_{Q,n}^{\text{eff}}$  is the Effective CBRN Challenge for challenge type  $Q$  and icon  $n$ ,

$t_k$  is the time variable,

$t_0$  is the first time point with non-zero CBRN Challenge,

$t_f$  is the time at which the CBRN Challenge ends,

$X_{Q,n,t_k}$  is the CBRN Challenge for challenge type  $Q$  and icon  $n$  at time  $t_k$  (derived from the output of the user's national hazard prediction model),

$APF_{n,t_{k-1}}$  is the Aggregate Protection Factor for icon  $n$  for time  $t_{k-1} \leq t < t_k$ , and

$Z$  is a special factor whose value depends upon the context, per the following list:

- a. For an inhaled chemical agent challenge,  $Z$  is the unitless factor described in Table 2-3 (related to the minute volume icon attribute). The

value can vary by time step and icon, so  $Z$  becomes  $Z_{n,t_{k-1}}$ .

- b. For an inhaled biological agent challenge,  $Z$  is the minute volume icon attribute [ $\text{m}^3/\text{min}$ ]. Table 2-3 lists default and suggested values. The value can vary by time step and icon, so  $Z$  becomes  $Z_{n,t_{k-1}}$ .
- c. For a percutaneous liquid chemical agent challenge,  $Z$  is the body surface area icon attribute [ $\text{m}^2$ ]. The default value is  $1 \text{ m}^2$ , and Section 2.1.4 contains user guidance relating to changing the value.
- d. For RDD challenges other than inhalation,  $Z$  is a dose conversion factor—it is used to convert from units of radioactivity (TBq) to units of absorbed dose (gray). Dose conversion factors do not vary with time or by icon, but they are isotope-specific and have different values for cloudshine, groundshine, skin contamination, and inhalation. Table 3-1 provides default values.
- e. For RDD inhalation challenge,  $Z$  is the mathematical product of the dose conversion factor for inhalation, default values of which are given in Table 3-1, and the minute volume icon attribute [ $\text{m}^3/\text{min}$ ]. Table 2-3 lists default and suggested values for the minute volume. As minute volume can vary by time step and icon,  $Z$  becomes  $Z_{n,t_{k-1}}$ .
- f. For a fallout groundshine challenge,  $Z$  is a gamma-to-beta dose conversion factor—it is used to calculate the beta radiation dose based on the gamma radiation dose. Table 3-2 provides default values.
- g. For a fallout skin contamination challenge,  $Z$  is a dose conversion factor—it is used to convert from units of radioactivity (TBq per area) to units of absorbed dose rate (gray per hour). The dose conversion factor does not vary by icon, and its variance with time is sufficiently slow and low-magnitude that it can be ignored. Table 3-2 provides default values.
- h. For nuclear challenges,  $Z$  is not needed, so its value is 1.

**Table 3-1: Suggested Dose Conversion Factors for RDDs for Selected Isotopes (Daughter Products Included)\***

Isotope*	Cloudshine [(Gy/hr)/(TBq/m <sup>3</sup> )]		Groundshine [(Gy/hr)/(TBq/m <sup>2</sup> )]		Skin Contamination [(Gy/hr)/(TBq/m <sup>2</sup> )]	Inhalation [Gy/TBq]
	Whole-Body (Z <sub>RDD,wb,cld,r</sub> )	Cutaneous (Z <sub>RDD,cut,cld,r</sub> )	Whole-Body (Z <sub>RDD,wb,grd,r</sub> )	Cutaneous (Z <sub>RDD,cut,grd,r</sub> )	Cutaneous (Z <sub>RDD,cut,s,r</sub> )	Whole-Body (Z <sub>RDD,wb,ih,r</sub> )
<sup>60</sup> Co†	6.4 x 10 <sup>2</sup>	7.3 x 10 <sup>2</sup>	8.5 x 10 <sup>0</sup>	9.9 x 10 <sup>0</sup>	7.8 x 10 <sup>1</sup>	7.2 x 10 <sup>2</sup>
<sup>90</sup> Sr§	3.8 x 10 <sup>-2</sup>	4.6 x 10 <sup>1</sup>	1.0 x 10 <sup>-3</sup>	5.0 x 10 <sup>-1</sup>	3.5 x 10 <sup>2</sup>	3.7 x 10 <sup>3</sup>
<sup>99</sup> Mo§	3.7 x 10 <sup>1</sup>	1.6 x 10 <sup>2</sup>	5.3 x 10 <sup>-1</sup>	1.4 x 10 <sup>-1</sup>	1.9 x 10 <sup>2</sup>	2.0 x 10 <sup>2</sup>
<sup>125</sup> I†	2.6 x 10 <sup>0</sup>	7.0 x 10 <sup>0</sup>	1.5 x 10 <sup>-1</sup>	4.1 x 10 <sup>-1</sup>	2.1 x 10 <sup>0</sup>	1.5 x 10 <sup>1</sup>
<sup>131</sup> I†	9.2 x 10 <sup>1</sup>	1.5 x 10 <sup>2</sup>	1.4 x 10 <sup>0</sup>	2.3 x 10 <sup>0</sup>	1.6 x 10 <sup>2</sup>	6.1 x 10 <sup>1</sup>
<sup>137</sup> Cs†	1.5 x 10 <sup>2</sup>	2.3 x 10 <sup>2</sup>	2.1 x 10 <sup>0</sup>	6.9 x 10 <sup>0</sup>	1.6 x 10 <sup>2</sup>	7.9 x 10 <sup>2</sup>
<sup>192</sup> Ir†	2.0 x 10 <sup>2</sup>	2.8 x 10 <sup>2</sup>	2.9 x 10 <sup>0</sup>	4.4 x 10 <sup>0</sup>	1.9 x 10 <sup>2</sup>	4.3 x 10 <sup>2</sup>
<sup>226</sup> Ra‡	1.6 x 10 <sup>0</sup>	2.4 x 10 <sup>0</sup>	2.3 x 10 <sup>-2</sup>	2.9 x 10 <sup>-2</sup>	0	2.2 x 10 <sup>3</sup>
<sup>238</sup> Pu‡	2.5 x 10 <sup>-2</sup>	2.1 x 10 <sup>-1</sup>	3.0 x 10 <sup>-3</sup>	3.5 x 10 <sup>-2</sup>	3.7 x 10 <sup>-1</sup>	1.4 x 10 <sup>4</sup>
<sup>241</sup> Am†	4.1 x 10 <sup>0</sup>	6.5 x 10 <sup>0</sup>	9.9 x 10 <sup>-2</sup>	3.0 x 10 <sup>-1</sup>	1.9 x 10 <sup>0</sup>	7.4 x 10 <sup>3</sup>
<sup>252</sup> Cf¥	2.5 x 10 <sup>-2</sup>	1.6 x 10 <sup>-1</sup>	2.6 x 10 <sup>-3</sup>	2.1 x 10 <sup>-2</sup>	3.2 x 10 <sup>-1</sup>	3.3 x 10 <sup>4</sup>

\* Values in this table were converted from units of sievert (equivalent dose) to gray (absorbed dose) assuming a relative biological effectiveness (RBE) of 1.<sup>52</sup> For cloudshine, the effective dose was multiplied by 1.4 to estimate the FIA whole body dose. The source of the inhalation factors states that they are for red marrow, not whole-body, but whole-body values are not available.

† Primarily a gamma emitter.

§ Primarily a beta emitter.

‡ Primarily an alpha emitter.

¥ Primarily a neutron emitter.

<sup>52</sup> Cloudshine: Keith F. Eckerman and Jeffrey C. Ryman, *External Exposure to Radionuclides in Air, Water, and Soil*, Federal Guidance Report No. 12, EPA-402-R-93-081 (Washington, DC: U.S. Environmental Protection Agency, September 1993), 58–73 (Table III.1). Groundshine: *ibid.*, 94–109 (Table III.3). Skin contamination: International Atomic Energy Agency (IAEA), *Generic Procedures for Assessment and Response During a Radiological Emergency*, IAEA-TECDOC-1162 (Vienna: IAEA, 2000), 103–104. Inhalation: International Atomic Energy Agency (IAEA), *Dangerous Quantities of Radioactive Material* (Vienna: IAEA, August 2006), 85–92.

**Table 3-2: Suggested Conversion Factors for Fallout**

Time After Detonation	Groundshine* (Z <sub>FO,cut,grd-β</sub> ) [(Gy from β)/Gy from γ]	Skin Contamination† (Z <sub>FO,cut,s</sub> ) [(Gy/hr)/(TBq/m <sup>2</sup> )]
0.5 hours	9.6	N/A
1 hour	8.2	2.62×10 <sup>-7</sup>
2 hours	7.8	2.59×10 <sup>-7</sup>
4 hours	9.5	2.59×10 <sup>-7</sup>
6 hours	11.7	2.59×10 <sup>-7</sup>
12 hours	13.7	2.57×10 <sup>-7</sup>
24 hours (1 day)	10.9	2.54×10 <sup>-7</sup>
48 hours (2 days)	8.2	2.49×10 <sup>-7</sup>
72 hours (3 days)	6.7	2.46×10 <sup>-7</sup>
168 hours (1 week)	5.0	2.41×10 <sup>-7</sup>
336 hours (2 weeks)	5.3	2.41×10 <sup>-7</sup>
720 hours (1 month)	6.7	2.43×10 <sup>-7</sup>
1440 hours (2 months)	8.5	2.41×10 <sup>-7</sup>
2880 hours (4 months)	9.6	2.38×10 <sup>-7</sup>
4320 hours (6 months)	11.0	2.38×10 <sup>-7</sup>
6480 hours (9 months)	16.0	2.41×10 <sup>-7</sup>
8760 hours (1 year)	26.5	2.41×10 <sup>-7</sup>
17,520 hours (2 years)	88.1	2.43×10 <sup>-7</sup>

\* For bare skin exposed to mixed fission products, 120 cm above ground.<sup>53</sup>

† For mixed fission products and a basal cell layer depth of 40 μm.<sup>54</sup>

- For chemical agent peak concentration, Equation 3-2 is used to identify the highest inhaled chemical agent concentration, after accounting for the APF.

$$X_{Q,n}^{\text{eff}} = \text{MAX} \left( \frac{X_{Q,n,t_k}}{\text{APF}_{n,t_k}} \right), \text{ for } 0 \leq k \leq f, \quad (3-2)$$

where all variables are as defined for Equation 3-1.

### 3.2. INPUT SCHEME 1 WITH TOXIC LOAD FOR CHEMICAL AGENTS

- For all chemical agent challenge types other than peak concentration, the user has the option to estimate the Effective CBRN Challenge while accounting for toxic load effects—that is, while (empirically) accounting for the body's natural repair and recovery mechanisms. One envisioned use of this option is to perform two separate casualty estimates—one with and one without accounting for toxic load effects—such that the results give a range that can be used for planning purposes.
- The toxic load-adjusted CBRN Effective Challenge can be calculated with

<sup>53</sup> Neil M. Barss and Ronald L. Weitz, "Reconstruction of External Dose for Beta Radiation Sources of Nuclear Weapon Origin," *Health Physics* 91, no. 4 (2006): 379–389, 385.

<sup>54</sup> Defense Threat Reduction Agency (DTRA), *Standard Method ED04 – Skin Dose from Dermal Contamination*, 1.3 ed. (Fort Belvoir, VA: DTRA, 31 January 2010), 9.

Equation 3-3. The basic form of the equation is the same as Equation 3-1. The difference is the additional term involving the TLE, or toxic load exponent, the purpose of which is to account for the rapidity with which the challenge accumulates as compared to the rapidity with which the body recovers from the challenge.

$$X_{Q,n}^{\text{TLE-eff}} = \sum_{k=1}^f \left[ \left( \frac{(X_{Q,n,t_k} - X_{Q,n,t_{k-1}}) \cdot Z_{n,t_{k-1}}}{\text{APF}_{Q,n,t_{k-1}}} \right) \cdot \left( \frac{t_k - t_{k-1}}{2 \text{ minutes}} \right)^{\left( \frac{1}{\text{TLE}} - 1 \right)} \right], \quad (3-3)$$

where:

$X_{Q,n}^{\text{TLE-eff}}$  is the Effective CBRN Challenge for challenge type Q and icon  $n$  as calculated while accounting for toxic load effects,

TLE is the toxic load exponent (values given in agent-specific subsections of Section 4.2), and

all other symbols and variables are as defined for Equation 3-1.

### 3.3. INPUT SCHEME 2

Each icon's Effective CBRN Challenge is not estimated by the methodology; rather, it is provided by the user as input (see Table 2-12 for example input).

**INTENTIONALLY BLANK**



## CHAPTER 4 CHEMICAL, RADIOLOGICAL, AND NUCLEAR HUMAN RESPONSE AND CASUALTY ESTIMATION

This chapter begins with a summary of the CRN modeling framework. Then, in separate sections for chemical agents, radiological agents, and nuclear effects, it discusses assumptions, limitations, and constraints, and describes, on an agent/effect-specific basis, how the methodology uses the Effective CBRN Challenge to estimate human response and casualties, including one flowchart per agent/effect that summarizes the process. In short, this chapter discusses the RESPONSE and STATUS steps of the methodology for CRN agents and effects.

### 4.1. CRN MODEL FRAMEWORK

#### 4.1.1. Human Response–Injury Profiles (CRN)

1. Each CRN agent and effect is associated with at least one challenge type (listed in Section 1.3.1). Each challenge type is further associated with a set of Injury Profiles. The method by which the challenged population is assigned to the different Injury Profiles depends upon the type of challenge, and is explained in Section 4.1.2.
2. Injury Profiles are the core of the CRN human response model.
  - a. Injury Profiles represent the time-dependent severity of symptoms manifested in physiological systems expected to manifest symptoms earliest and at the highest severity (lesser symptoms are ignored).
  - b. Injury Profiles model changes in Injury Severity Level as step functions; the step occurs when the new value is reported. Thus, for example, the GB Mild Injury Profile (Table 4-5) indicates Injury Severity Level 1 between 15 and 150 minutes, and an abrupt change to Injury Severity Level 0 at 150 minutes.
  - c. Each Injury Profile relates to a set of symptoms that is clinically differentiable from each other Injury Profile for the given agent or effect.
  - d. Injury Profiles are intended to represent the typical individual exhibiting the given level of response.
  - e. The methodology accounts for the synergy of multiple challenge types from a single agent or effect via Composite Injury Profiles. Specifically, VX, HD, CG, CK, RDDs, and fallout each have multiple challenge types that are combined via Composite Injury Profiles, as shown in the flowcharts in Sections 4.2 and 4.3. The three separate effects of nuclear weapons *cannot* be combined via Composite Injury Profiles.
  - f. Composite Injury Profiles are produced by overlaying multiple individual Injury

Profiles and selecting the maximum Injury Severity Level at each time point. Figure 4-1 provides the logic for generating Composite Injury Profiles, and Figure 4-2 is an example of a Composite Injury Profile based on three notional Injury Profiles.

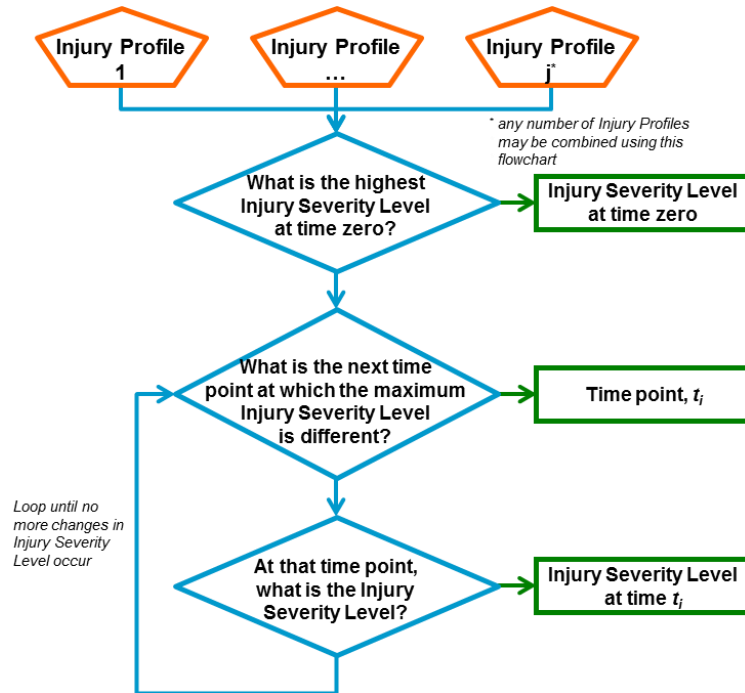

Figure 4-1: Flowchart for Generation of Composite Injury Profiles

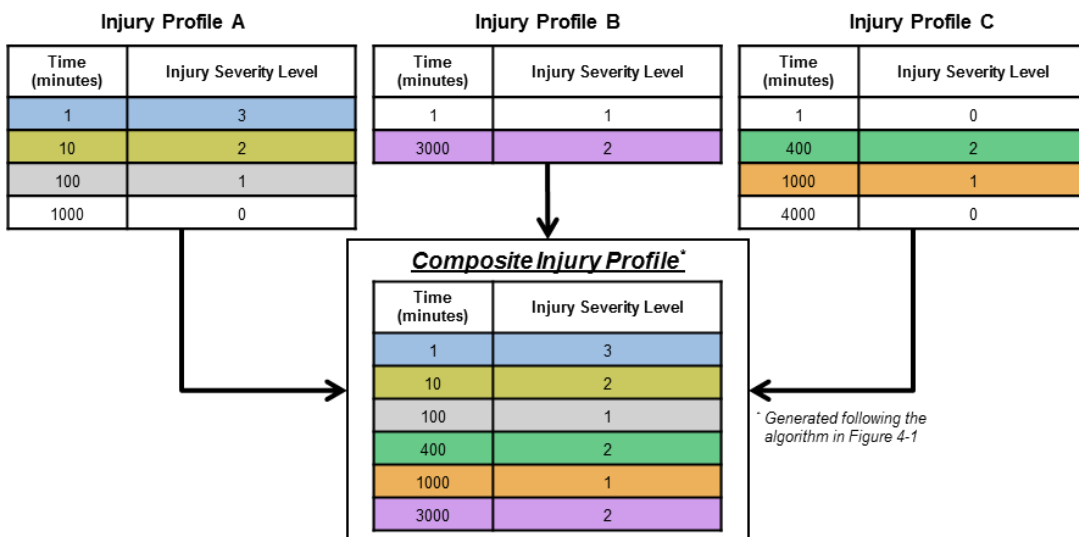

Figure 4-2: Notional Example of Composite Injury Profile Generation

3. The group of individuals assigned to a given (Composite) Injury Profile<sup>55</sup> is referred to as an Injury Profile cohort.
4. The Injury Profile is input to the casualty estimation portion of the methodology, which determines outcomes for the Injury Profile cohort.
5. If Flag<sub>MT</sub> = No (untreated models).
  - a. Injury Profiles are used to determine when changes in casualty category occur, including changes in the Injury Severity Level of WIAs (changes in the # in WIA(#)).
  - b. All individuals in each Injury Profile cohort (chemical) or in each icon (radiological/nuclear) are estimated to exhibit the same human response.
6. If Flag<sub>MT</sub> = Yes (treated models).
  - a. Injury Profiles are only used until the cohort or icon enters the medical system—the Injury Profile is used to determine when the individuals become WIA, the value of # when the casualties enter the medical system, and if/when the casualties become KIA.
  - b. The medical treatment models do *not* have information on changes in Injury Severity Level over time; rather, they only show if/when the casualties become DOW, CONV, or RTD. Thus, when Flag<sub>MT</sub> = Yes, the personnel status output tables cannot report changes in Injury Severity Level over time.
  - c. To avoid the nonsensical situation of a cohort or icon entering the medical system at Injury Severity Level 4 (per the Injury Profile), remaining at Injury Severity Level 4, and then becoming CONV or RTD days later, survivors in cohorts and icons that are WIA(4) on Day 1 and reach medical treatment will be reported as WIA(3) on Day 2, after which they will remain as WIA(3) until otherwise indicated by the medical treatment outcome reporting table.
  - d. Finally, all individuals in an Injury Profile cohort or icon are not necessarily estimated to have the same outcome.
7. Medical treatment outcome reporting tables (such as Table 4-6, for GB) specify how outcomes for each Injury Profile cohort are *reported*. WIA and KIA are not included because they occur before casualties reach the medical system. The DOW, CONV, and RTD columns specify what fraction of casualties (if any) are reported as DOW, CONV, or RTD on a given day (consistent with the rules in Table 1-4). The values are not cumulative over time.

---

<sup>55</sup> As appropriate, later references to “Injury Profile” in this chapter should be taken to mean either an Injury Profile or a Composite Injury Profile.

#### 4.1.2. Assignment of Personnel to Injury Profiles

1. Chemical agents.
  - a. The PAR must be split into Injury Profile cohorts. Several agents require the use of Composite Injury Profiles, and determining the population of each Injury Profile cohort is not trivial because of the probabilistic nature of the models.
  - b. For all chemical agent challenge types except CG and CK peak concentration, the first step is to use probit calculations to estimate the probability of individuals exhibiting certain effects. Probit calculations use toxicity parameters (ECt<sub>50</sub><sup>56</sup> and probit slope, or PS).
    - 1) For some generic health effect, *k*, caused by challenge type Q, the probability that an individual in icon *n* will exhibit effect *k* is calculated according to Equation 4-1.

$$p_{Q,k,n} = \Phi \left( PS_{Q,k} \cdot \log_{10} \left( \frac{X_{Q,n}^{\text{eff}}}{ECt_{50,Q,k}} \right) \right), \quad (4-1)$$

where:

the value of *k* is typically either mild, moderate, severe, or very severe,<sup>57</sup>

$p_{Q,k,n}$  is the probability that the individual in icon *n* will exhibit symptoms related to challenge type Q that are *at least as severe* as effect *k*,

$\Phi$  is the standard normal cumulative distribution function,

$PS_{Q,k}$  is the base 10 probit slope associated with challenge type Q and effect *k* (values given in agent-specific parts of Section 4.2),

ECt<sub>50,Q,k</sub> is the median toxicity associated with challenge type Q and effect *k* (values given in agent-specific parts of Section 4.2), and

$X_{Q,n}^{\text{eff}}$  is the Effective CBRN Challenge for challenge type Q and icon *n*.

- 2) Each challenge type is associated with multiple sets of toxicity parameters, with each set representing a different severity of effect. The population exhibiting more severe effects is a subset of the population exhibiting less severe effects. Double counting is avoided, mathematically, via Equation 4-2, which calculates the probability that the *worst* symptoms related to challenge type Q that an individual in icon *n* will exhibit are those of effect *k*.

<sup>56</sup> Or ED<sub>50</sub>, LCt<sub>50</sub>, or LD<sub>50</sub>; ECt<sub>50</sub> will be used in the following discussion and equations.

<sup>57</sup> "Very severe" is used to be consistent with Table 1-3, but the toxicity parameters are typically reported in other documents as for "lethal," that is, as LCt<sub>50</sub> or LD<sub>50</sub> and PS<sub>lethal</sub>.

$$p_{w,Q,k,n} = p_{Q,k,n} - p_{Q,k+1,n}, \quad (4-2)$$

where:

$p_{w,Q,k,n}$  is the probability that the *worst* symptoms an individual in icon  $n$  will exhibit related to challenge type  $Q$  are those of effect  $k$ ,

$p_{Q,k,n}$  is as defined for Equation 4-1, and

$p_{Q,k+1,n}$  is the probability that an individual in icon  $n$  will exhibit symptoms from challenge type  $Q$  that are *worse* than those associated with effect  $k$  (calculated using Equation 4-1 with toxicity parameters *one step worse* than those associated with effect  $k$ <sup>58</sup>).

- 3) In the preceding explanation,  $k$  has related to specific effects. However, methodologically, it can also relate to a specific threshold value of the Effective CBRN Challenge. For example, the four Injury Profiles for GB (Table 4-5) each relate to specific effects. However, when Flag<sub>MT</sub> = Yes, the GB medical treatment outcome reporting table (Table 4-6) shows that Very Severe casualties are actually split into two cohorts, based on whether  $X_{GB,ih,n}^{eff}$  is greater than or less than a specified threshold. Several other agents also have Injury Profiles defined by *both* the effect (in general terms like Mild or Severe) *and* by whether the Effective CBRN Challenge is greater than or less than some threshold. In the following discussion, the symbol  $k$  represents Injury Profiles in general, whether they are defined only by an effect, or by an effect and a threshold.

- c. For CG and CK peak concentration, Effective CBRN Challenge *ranges* (listed in Table 4-28 and Table 4-42) are used to determine the population of the Injury Profile cohorts. Effective CBRN Challenge ranges are a set of mutually exclusive bins into which an icon may be placed, depending on its Effective CBRN Challenge. Each bin is associated with a specific Injury Profile. Equation 4-3 is used to calculate probabilities related to Effective CBRN Challenge ranges.

$$p_{w,Q,k,n} = \begin{cases} 1 & \text{if } X_{Q,k,min}^{eff} \leq X_{Q,n}^{eff} < X_{Q,k,max}^{eff}, \\ 0 & \text{otherwise} \end{cases}, \quad (4-3)$$

where:

$X_{Q,k,min}^{eff}$  is the lower end of the Effective CBRN Challenge range associated with challenge type  $Q$  and Injury Profile  $k$ ,

$X_{Q,k,max}^{eff}$  is the upper end of the Effective CBRN Challenge range

---

<sup>58</sup> For example, if effect  $k$  is related to the Mild toxicity parameters, then  $p_{Q,k+1,n}$  would be calculated using the Moderate toxicity parameters.

associated with challenge type Q and Injury Profile  $k$ ,  
and other symbols are as previously defined.

- d. For chemical agents with only one challenge type (GB, Cl<sub>2</sub>, AC, H<sub>2</sub>S—see Table 2-2), the results of Equation 4-2 are directly used to determine the Injury Profile cohort populations, per Equation 4-4.

$$\text{Pop}_{\text{IP,Q}_k} = \sum_n (i_n \cdot p_{w,Q_k,n}), \quad (4-4)$$

where:

Pop<sub>IP,Q<sub>k</sub></sub> is the population of the Injury Profile cohort associated with challenge type Q and effect  $k$ ,

the  $p_{w,Q_k,n}$  come from Equation 4-2, and

$i_n$  is the population of icon  $n$ .

- e. For chemical agents with two challenge types (CG, CK, and VX—see Table 2-2), the different probabilities related to the different challenge types must be combined appropriately. The following sub-points use the following construct: effects of severity  $k$  result from challenge type A, and effects of severity  $j$  result from challenge type B;  $k$  and  $j$  have multiple possible values (levels of severity), including “no effect.”

- 1) Equation 4-5 is used to calculate the population of the Composite Injury Profile cohorts related to the combined effects of challenge types A and B. For any combination of effect  $k$  and effect  $j$ , the *worst* effect exhibited from challenge type A is effect  $k$ , and the worst effect exhibited from challenge type B is  $j$ . This equation should be used for each relevant combination of  $k$  and  $j$  in which neither  $k$  nor  $j$  relates to “no symptoms.”<sup>59</sup>

$$\text{Pop}_{\text{IP,A}_k\text{,B}_j} = \sum_n [i_n \cdot (p_{w,A_k,n} \cdot p_{w,B_j,n})], \quad (4-5)$$

where:

Pop<sub>IP,A<sub>k</sub>,B<sub>j</sub></sub> is the cohort population for the Composite Injury Profile generated by combining the Injury Profiles for effects  $k$  and  $j$ ,

the  $p_{w,A_k,n}$  and  $p_{w,B_j,n}$  come from Equation 4-2 or 4-3, and

other symbols are as previously defined.

- 2) Continuing from the above scenario, the population that exhibits *only* effect

<sup>59</sup> The number of possible combinations depends on the agent, but as an example, if both effects could be Mild, Moderate, Severe, or Very Severe, there are  $4 * 4 = 16$  possible combinations.

$k$  can be calculated by Equation 4-6, which subtracts the population that exhibits effect  $k$  plus any other effect from the total population that exhibits effect  $k$ . Equation 4-7 analogously calculates the population that exhibits *only* effect  $j$ .

$$\text{Pop}_{\text{IP,A}_k} = \sum_n \left[ i_n \cdot \left( p_{w,A_k,n} - \sum_j (p_{w,A_k,n} \cdot p_{w,B_j,n}) \right) \right], \quad (4-6)$$

$$\text{Pop}_{\text{IP,B}_j} = \sum_n \left[ i_n \cdot \left( p_{w,B_j,n} - \sum_k (p_{w,B_j,n} \cdot p_{w,A_k,n}) \right) \right], \quad (4-7)$$

where:

$\text{Pop}_{\text{IP,A}_k}$  is the cohort population following the effect  $k$  Injury Profile,

$\text{Pop}_{\text{IP,B}_j}$  is the cohort population following the effect  $j$  Injury Profile,

the  $p_{w,A_k,n}$  and  $p_{w,B_j,n}$  could come from Equation 4-2 or 4-3, and

other symbols are as previously defined.

- f. For chemical agents with three challenge types (only HD—see Table 2-2), a process analogous to that used for chemical agents with two challenge types is used to determine the cohort populations for the various possible combinations. As the concept is the same, the equations are simply stated below, without explanation. The construct is that effects of severity  $k$  result from challenge type A, effects of severity  $j$  result from challenge type B, and effects of severity  $i$  result from challenge type C;  $k$ ,  $j$ , and  $i$  have multiple possible values (levels of severity).

$$\text{Pop}_{\text{IP,A}_k\text{B}_j\text{C}_i} = \sum_n \left[ i_n \cdot (p_{w,A_k,n} \cdot p_{w,B_j,n} \cdot p_{w,C_i,n}) \right] \quad (4-8)$$

$$\text{Pop}_{\text{IP,A}_k\text{B}_j} = \sum_n \left[ i_n \cdot \left( p_{w,A_k,n} \cdot p_{w,B_j,n} - \sum_i (p_{w,A_k,n} \cdot p_{w,B_j,n} \cdot p_{w,C_i,n}) \right) \right] \quad (4-9)$$

$$\text{Pop}_{\text{IP,A}_k\text{C}_i} = \sum_n \left[ i_n \cdot \left( p_{w,A_k,n} \cdot p_{w,C_i,n} - \sum_j (p_{w,A_k,n} \cdot p_{w,B_j,n} \cdot p_{w,C_i,n}) \right) \right] \quad (4-10)$$

$$\text{Pop}_{\text{IP,B}_j\text{C}_i} = \sum_n \left[ i_n \cdot \left( p_{w,B_j,n} \cdot p_{w,C_i,n} - \sum_k (p_{w,A_k,n} \cdot p_{w,B_j,n} \cdot p_{w,C_i,n}) \right) \right] \quad (4-11)$$

$$\text{Pop}_{\text{IP,A}_k} = \sum_n \left[ i_n \cdot \left( p_{w,A_k,n} - \sum_j (p_{w,A_k,n} \cdot p_{w,B_j,n}) - \sum_i (p_{w,A_k,n} \cdot p_{w,C_i,n}) \right) \right] \quad (4-12)$$

$$\text{Pop}_{\text{IP,B}_j} = \sum_n \left[ i_n \cdot \left( p_{w,B_j,n} - \sum_k (p_{w,A_k,n} \cdot p_{w,B_j,n}) - \sum_i (p_{w,B_j,n} \cdot p_{w,C_i,n}) \right) \right] \quad (4-13)$$

$$\text{Pop}_{\text{IP,C}_i} = \sum_n \left[ i_n \cdot \left( p_{w,C_i,n} - \sum_k (p_{w,A_k,n} \cdot p_{w,C_i,n}) - \sum_j (p_{w,B_j,n} \cdot p_{w,C_i,n}) \right) \right] \quad (4-14)$$

2. Radiological agents. As with chemical agents, the PAR must be split into Injury Profile cohorts. Because of the non-probabilistic nature of Effective CBRN Challenge ranges, the process of determining the populations of the Composite Injury Profile cohorts is relatively simple, and is done entirely within the flowcharts in Section 4.3.

3. Nuclear effects. For each individual effect, the process is similar to radiological agents, and is described in the flowcharts in Section 4.4. Each icon will belong to three different dose or insult ranges, one per challenge type.

#### 4.1.3. Casualty Estimation

1. In all cases, individuals become WIA if/when dictated by their Injury Profile and the logic in Figure 1-1.

2. KIA and DOW.

- a. In general, Equation 4-15 is used to determine whether a casualty who dies is KIA or DOW: if Equation 4-15 is TRUE, the casualty is KIA, and if it is FALSE, the casualty is DOW.

$$T_{\text{death,Q}} < T_{\text{MTF}} + T_{\text{WIA}}, \quad (4-15)$$

where:

$T_{\text{death,Q}}$  is the time at which the casualty is estimated to die from injuries caused by challenge type Q,

$T_{\text{MTF}}$  is as defined in Section 2.2 (default value of 30 minutes, per Table 2-14), and

$T_{\text{WIA}}$  is the time at which the casualty was declared WIA.

- b. Untreated<sup>60</sup> chemical, nuclear blast, and nuclear burn casualties are estimated

<sup>60</sup> Including *not yet treated* casualties en route to a MTF (relevant when  $\text{Flag}_{\text{MT}} = \text{Yes}$ ). Once such casualties reach a MTF, their outcomes are determined by the appropriate medical treatment model.



to die if their symptoms are at Injury Severity level 4 for longer than  $T_{\text{death-CN-SL4}}$ . In that case,  $T_{\text{death,Q}}$  is replaced by  $T_{\text{death,CN}}$ , which is estimated according to Equation 4-21.

$$T_{\text{death,CN}} = T_{\text{SL4}} + T_{\text{death-CN-SL4}}, \quad (4-16)$$

where:

$T_{\text{SL4}}$  is the time at which the casualty's Injury Severity Level becomes 4, and

$T_{\text{death-CN-SL4}}$  is as defined in Section 2.2 (default value of 15 minutes, per Table 2-14).

- c. Treated chemical, nuclear blast, and nuclear burn casualties are estimated as DOW if so indicated by the relevant medical treatment outcome reporting table (tables located in sub-parts of Sections 4.2, 4.3, and 4.4).
  - d. Regardless of the value of  $\text{Flag}_{\text{MT}}$ , RDD, fallout, and initial whole-body radiation (nuclear) casualties are estimated to die if their icon's total whole-body dose [Gy] is greater than a threshold dose.
    - 1) For RDDs and fallout, that threshold is  $D_{\text{death,wb},n}$ , which is calculated as described in Section 4.3.4. Time of death is estimated by Equation 4-33.
    - 2) For initial whole-body radiation (nuclear), that threshold is 4.5 Gy. Time of death is estimated by Equation 4-35.
3. CONV and RTD
- a. If  $\text{Flag}_{\text{MT}} = \text{No}$ , casualties become RTD if/when their Injury Severity Level returns to zero, as indicated by their Injury Profile. CONV is not estimated.
  - b. If  $\text{Flag}_{\text{MT}} = \text{Yes}$ , casualties become CONV and/or RTD as dictated by the relevant line of the medical treatment outcome reporting table for the challenge that caused their injury (tables located in sub-parts of Sections 4.2, 4.3, and 4.4).
4. The agent/effect-specific flowcharts in Sections 4.2, 4.3, and 4.4 contain declarations of how casualties should be reported, such as "Report as KIA." Each flowchart also notes that specific information is to be passed to Equation 4-17 (chemical), which sums over the different Injury Profile cohorts, or to Equation 4-18 (radiological and nuclear), which sums over all icons. Each equation generates the overall daily new casualty estimate for each casualty category. As indicated in the flowcharts, casualty information relating only to personnel status is not used in these equations.

$$\text{New}_{\text{CAT}}(d) = \sum_{\text{IPs}} (\text{Pop}_{\text{IP}} \cdot f_{\text{new-CAT}}(d)), \quad (4-17)$$

$$\text{New}_{\text{CAT}}(d) = \sum_n (i_n \cdot f_{\text{new-CAT}}(d)), \quad (4-18)$$

where:

CAT is a casualty category (KIA, WIA, DOW, CONV, or RTD),

$\text{New}_{\text{CAT}}(d)$  is the number of individuals who are reported as *new* CAT on day  $d$ , rounded to the nearest integer,<sup>61</sup>

$\text{Pop}_{\text{IP}}$  is the population of a given Injury Profile cohort (calculated in Section 4.1.2),

$i_n$  is the number of individuals in icon  $n$ ,

$f_{\text{new-CAT}}(d)$  is the fraction of the Injury Profile cohort or icon that is reported as new CAT on day  $d$ , as indicated by an agent- or effect-specific flowchart in Section 4.2, 4.3, or 4.4 (the value is typically 1.0, but may be lower if  $\text{Flag}_{\text{MT}} = \text{Yes}$ ), and

the summation in Equation 4-17 should be over all relevant Injury Profiles and/or Composite Injury Profiles.

5. Once the daily new casualty estimate has been produced, the daily personnel status estimate—total numbers of casualties reported in each category on each day—can be produced using Equations 4-19 and 4-20.

$$\text{Tot}_{\text{CAT}}(d) = \text{Tot}_{\text{CAT}}(d - 1) + \sum_{\text{IPs}} (\text{Pop}_{\text{IP}} \cdot (f_{\text{new-CAT}}(d) - f_{\text{ex-CAT}}(d))), \quad (4-19)$$

$$\text{Tot}_{\text{CAT}}(d) = \text{Tot}_{\text{CAT}}(d - 1) + \sum_n (i_n \cdot (f_{\text{new-CAT}}(d) - f_{\text{ex-CAT}}(d))), \quad (4-20)$$

where:

CAT is a casualty category (KIA, a WIA(#), DOW, CONV, or RTD),

$\text{Pop}_{\text{IP}}$ ,  $i_n$ , and  $f_{\text{new-CAT}}(d)$  are as defined above,

$\text{Tot}_{\text{CAT}}(d)$  is the number of individuals who are reported as CAT on day  $d$ , rounded to the nearest integer,<sup>61</sup>

$f_{\text{ex-CAT}}(d)$  is the number of individuals who were CAT on day  $(d - 1)$  but are no longer CAT as of day  $d$ , as indicated by an agent- or effect-specific flowchart in Sections 4.2, 4.3, or 4.4, and

<sup>61</sup> Because of how the agent/effect-specific flowcharts and related equations are constructed, these values will intrinsically be consistent with the reporting rules of Table 1-4.

the summation in Equation 4-19 should be over all relevant Injury Profiles and/or Composite Injury Profiles.

6. After Equation 4-17 or 4-18 and Equation 4-19 or 4-20 are applied to each casualty category on each day, the methodology continues by reporting the outputs, as described in Chapter 6.

## 4.2. CHEMICAL AGENT MODELS

This section begins with a discussion of methodological features and assumptions that apply only to chemical agents. Following that is one section on each chemical agent, each of which describes in full detail how the methodology uses the Effective CBRN Challenge to estimate human response and casualties for one agent. For each agent, a flowchart summarizes the process from Effective CBRN Challenge to casualty estimate. As necessary, agent-specific equations for estimating Effective CBRN Challenge, and other special considerations, are also discussed.

### 4.2.1. Assumption and Constraint

1. Assumption. All individuals are 70 kilogram males.
2. Constraint. The user must choose to use either Haber's rule or toxic load modeling. Haber's rule states that the severity of toxic effects from chemical agents depends only upon the total challenge, independent of the duration during which the challenge was accumulated. Toxic load modeling is an empirical attempt to account for the body's natural repair and recovery mechanisms. For agents with toxic load exponent greater than 1.0, the effect of toxic load modeling is that if the challenge is accumulated over a relatively long time, the human response will be less severe than if the challenge was accumulated over a relatively short time. No agents in this methodology have toxic load exponent less than 1.0. It is not clear which choice produces a more accurate casualty estimate; having the option allows the user to generate a range of estimates by running the methodology once for each option.

### 4.2.2. GA

1. Figure 4-3 summarizes the human response and casualty estimation processes for GA.
2. Assumption and limitation.
  - a. Assumption. Percutaneous exposure to GA vapor is negligible.
  - b. Limitation. Percutaneous exposure to GA liquid is not included; note, however, that the GA percutaneous liquid threat is not negligible.
3. Inhalation is the only GA challenge type considered. Each icon's inhaled Ct ( $X_{GA,ih,n}^{eff}$ ) is estimated according to Chapter 3.

4. Special consideration for GA. If  $Flag_{MT} = \text{Yes}$ , the user must further specify whether the available medical treatment includes only self-aid and buddy aid (individual issue autoinjectors), or if it also includes further medical treatment at a MTF. This choice is captured in the parameter  $MT_{GA}$ , which can have the values “SABA” (self-aid/buddy aid) or “FMT” (further medical treatment). The default value is FMT. Using SABA may be warranted in MASCAL scenarios where it is anticipated that insufficient resources will be available.

5. For inhaled GA, Table 4-1 summarizes the toxicity parameters and associated symptoms, Table 4-2 fully describes the associated Injury Profiles, and Table 4-3 describes the outcomes associated with medical treatment.

**Table 4-1: Inhaled GA Toxicity Parameters and Symptoms**

Injury Profile Label	EC <sub>t50</sub> [mg-min/m <sup>3</sup> ]	Probit Slope [probits/log(dose)]	TLE	Associated Symptoms
Mild	0.4	4.5	1.5	Miosis; rhinorrhea; transient chest tightness
Moderate	1.2	12	1.5	Rhinorrhea; blurred vision or eye pain with sensitivity to light; mild headache; excessive airway secretions induce frequent cough; nausea
Severe	50	12	1.5	Increased secretions and eye effects; vomiting; abdominal cramps; severe headache with anxiety and confusion; tight chest; twitching; weakness; diarrhea; convulsions
Very Severe	70	12	1.5	Collapse; respiratory failure; death without (and maybe in spite of) medical intervention

**Table 4-2: Inhaled GA Injury Profiles**

Time Point [min]	Injury Profile			
	Mild	Moderate	Severe	Very Severe
1	0	2	3	4
3	1	2	3	4
15	1	2	3	4*
150	0	2	3	
1000	0	2	2	
1940	0	1	2	
8640	0	1	1	

\* According to the default value for  $T_{\text{death-CN-SL4}}$ , death would be modeled at this point.

**Table 4-3: GA Medical Treatment Outcome Reporting**

Injury Profile	DOW*	CONV*	RTD*
Mild	0%	Day 2: 100%	Day 8: 100%
Moderate	0%	Day 3: 100%	Day 15: 100%
Severe	0%	Day 4: 50% Day 5: 50%	Day 31: 100%

Injury Profile	DOW*	CONV*	RTD*
If $MT_{GA} = \text{SABA}$ (self-aid/buddy aid only)			
Very Severe, $X_{GA,ih}^{eff} < 210$	0%	Day 15: 100%†	0%
Very Severe, $X_{GA,ih}^{eff} \geq 210$	Day 2: 100%	0%	0%
If $MT_{GA} = \text{FMT}$ (self-aid/buddy aid + further medical treatment)			
Very Severe, $X_{GA,ih}^{eff} < 350$	0%	Day 15: 100%†	0%
Very Severe, $X_{GA,ih}^{eff} \geq 350$	Day 2: 100%	0%	0%

\* Reported values indicate the fraction that changes status on a given day; they are not cumulative.

† In the personnel status table, these individuals are reported as WIA(3) on Day 2 and remain there until becoming CONV.

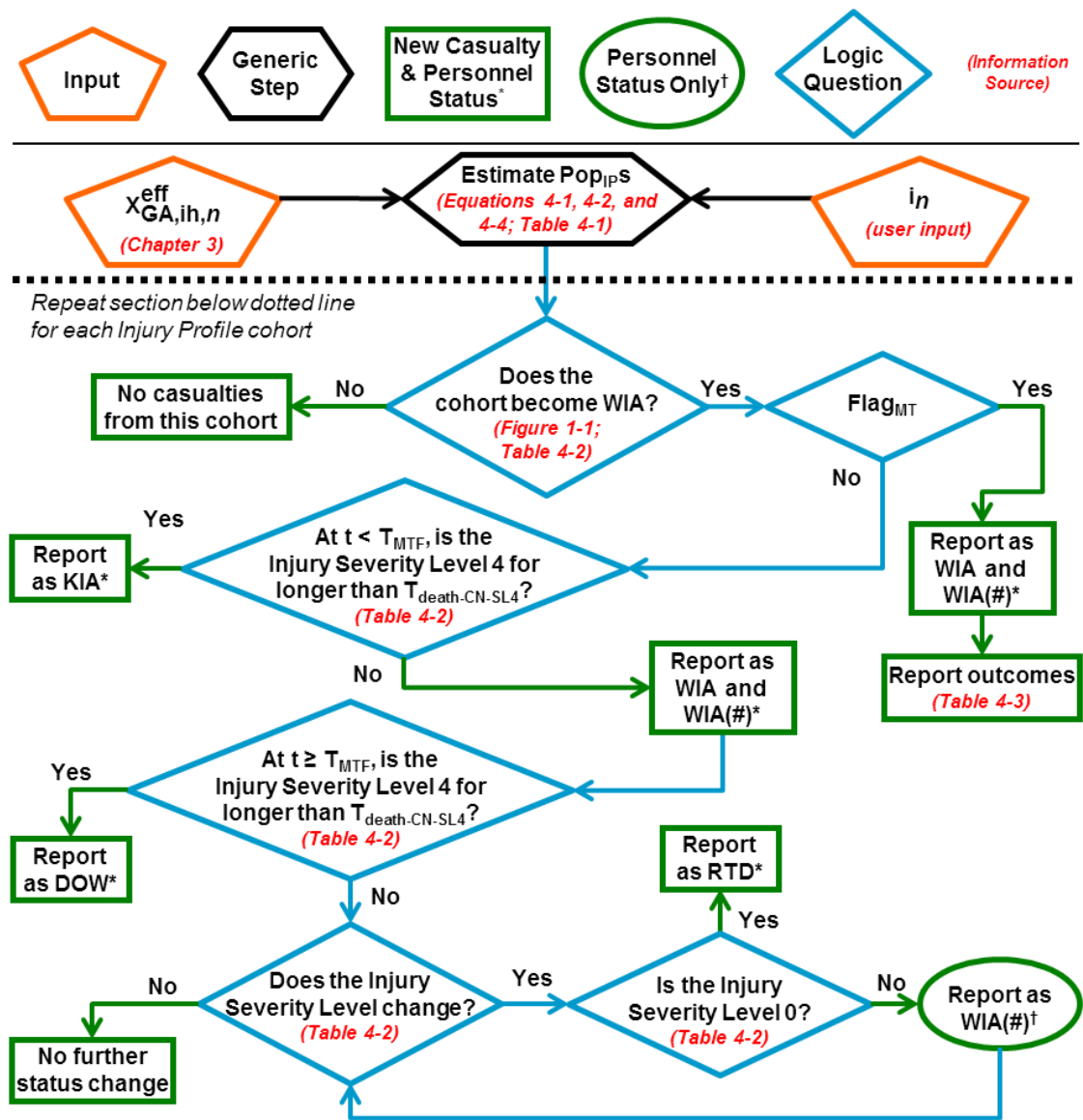

\* Casualty information ( $Pop_{IP}$ ,  $CAT$ ,  $f_{new-CAT}$ ,  $f_{ex-CAT}$ , and  $d$ ) is passed to Equations 4-17 and 4-19.

† Personnel status information ( $Pop_{IP}$ ,  $CAT$ ,  $f_{new-CAT}$ ,  $f_{ex-CAT}$ , and  $d$ ) is passed to Equation 4-19.

Figure 4-3: Human Response Casualty Estimation Flowchart for GA

### 4.2.3. GB

1. Figure 4-4 summarizes the human response and casualty estimation processes for GB.
2. Assumption. Percutaneous exposure to GB vapour and liquid are negligible.
3. Inhalation is the only GB challenge type considered. Each icon's inhaled Ct ( $X_{GB,ih,n}^{eff}$ ) is estimated according to Chapter 3.
4. Special consideration for GB. If  $Flag_{MT} = \text{Yes}$ , the user must further specify whether the available medical treatment includes only self-aid and buddy aid (individual issue autoinjectors), or if it also includes further medical treatment at a MTF. This choice is captured in the parameter  $MT_{GB}$ , which can have the values "SABA" (self-aid/buddy aid) or "FMT" (further medical treatment). The default value is FMT. Using SABA may be warranted in MASCAL scenarios where it is anticipated that insufficient resources will be available.
5. For inhaled GB, Table 4-4 summarizes the toxicity parameters and associated symptoms, Table 4-5 fully describes the associated Injury Profiles, and Table 4-6 describes the outcomes associated with medical treatment.

**Table 4-4: Inhaled GB Toxicity Parameters and Symptoms**

Injury Profile Label	EC <sub>50</sub> [mg-min/m <sup>3</sup> ]	Probit Slope [probits/log(dose)]	TLE	Associated Symptoms
Mild	0.4	4.5	1.4	Miosis; rhinorrhea; transient chest tightness
Moderate	1.2	12	1.5	Rhinorrhea; blurred vision or eye pain with sensitivity to light; mild headache; excessive airway secretions induce frequent cough; nausea
Severe	25	12	1.5	Increased secretions and eye effects; vomiting; abdominal cramps; severe headache with anxiety and confusion; tight chest; twitching; weakness; diarrhea; convulsions
Very Severe	33	12	1.5	Collapse; respiratory failure; death without (and maybe in spite of) medical intervention

**Table 4-5: Inhaled GB Injury Profiles**

Time Point [min]	Injury Profile			
	Mild	Moderate	Severe	Very Severe
1	0	2	3	4
3	1	2	3	4
15	1	2	3	4*
150	0	2	3	
1000	0	2	2	
1940	0	1	2	
8640	0	1	1	

\* According to the default value for  $T_{\text{death-CN-SL4}}$ , death would be modeled at this point.

**Table 4-6: GB Medical Treatment Outcome Reporting**

Injury Profile	DOW*	CONV*	RTD*
Mild	0%	Day 2: 100%	Day 8: 100%
Moderate	0%	Day 3: 100%	Day 15: 100%
Severe	0%	Day 4: 50% Day 5: 50%	Day 31: 100%
If $MT_{\text{GB}} = \text{SABA}$ (self-aid/buddy aid only)			
Very Severe, $X_{\text{GB,ih}}^{\text{eff}} < 100$	0%	Day 15: 100%†	0%
Very Severe, $X_{\text{GB,ih}}^{\text{eff}} \geq 100$	Day 2: 100%	0%	0%
If $MT_{\text{GB}} = \text{FMT}$ (self-aid/buddy aid + further medical treatment)			
Very Severe, $X_{\text{GB,ih}}^{\text{eff}} < 165$	0%	Day 15: 100%†	0%
Very Severe, $X_{\text{GB,ih}}^{\text{eff}} \geq 165$	Day 2: 100%	0%	0%

\* Reported values indicate the fraction that changes status on a given day; they are not cumulative.

† In the personnel status table, these individuals are reported as WIA(3) on Day 2 and remain there until becoming CONV.

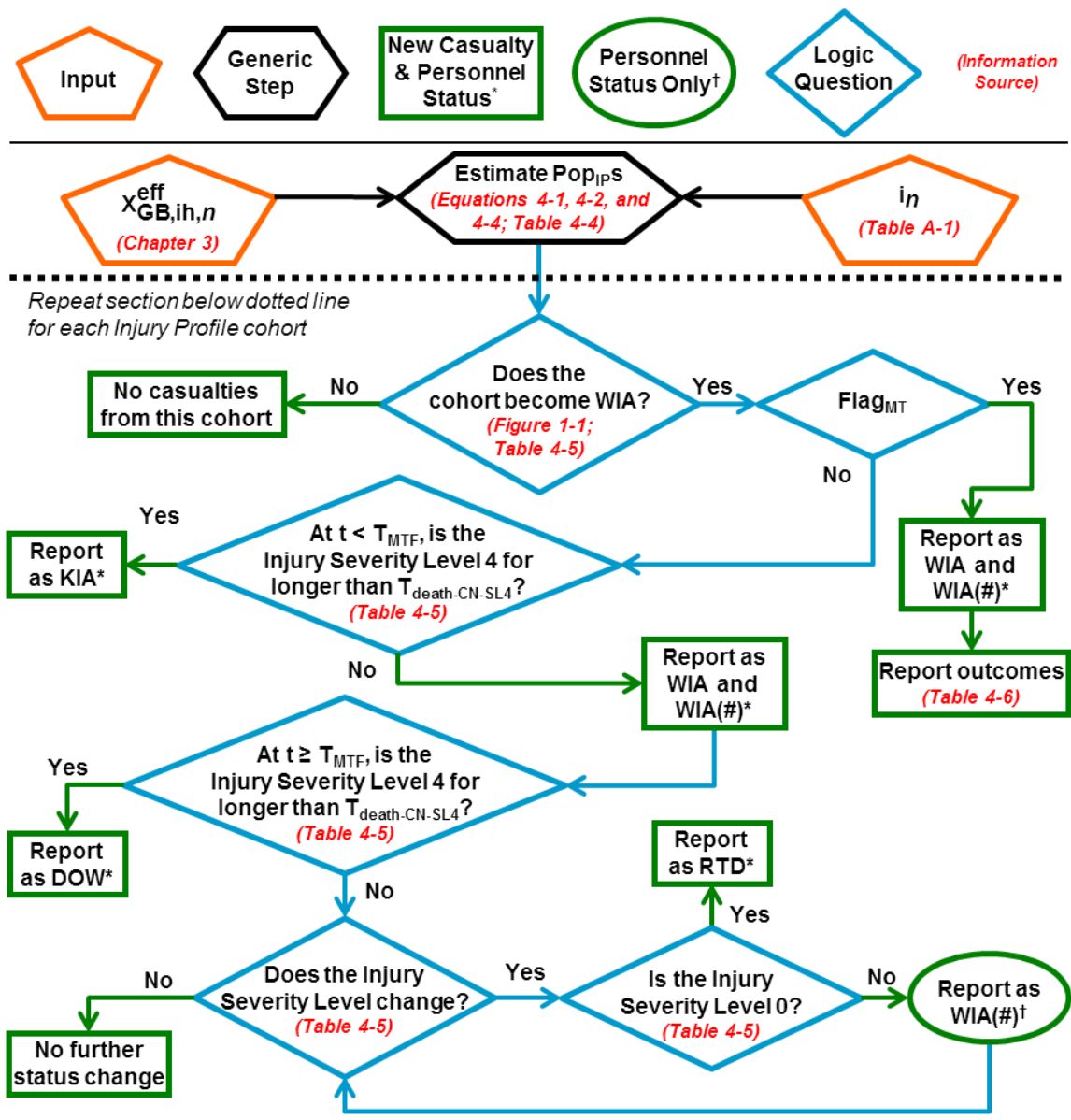

\* Casualty information ( $Pop_{IP}$ ,  $CAT$ ,  $f_{new-CAT}$ ,  $f_{ex-CAT}$ , and  $d$ ) is passed to Equations 4-17 and 4-19.  
 † Personnel status information ( $Pop_{IP}$ ,  $CAT$ ,  $f_{new-CAT}$ ,  $f_{ex-CAT}$ , and  $d$ ) is passed to Equation 4-19.

**Figure 4-4: Human Response Casualty Estimation Flowchart for GB**

**4.2.4. GD**

1. Figure 4-5 summarizes the human response and casualty estimation processes for GD.
2. Assumption and limitation.
  - a. Assumption. Percutaneous exposure to GD vapor is negligible.
  - b. Limitation. Percutaneous exposure to GD liquid is not included; note, however, that the GD percutaneous liquid threat is not negligible.



3. Inhalation is the only GD challenge type considered. Each icon’s inhaled Ct ( $X_{GD,ih,n}^{eff}$ ) is estimated according to Chapter 3.

4. Special consideration for GD. If  $Flag_{MT} = \text{Yes}$ , the user must further specify whether the available medical treatment includes only self-aid and buddy aid (individual issue autoinjectors), or if it also includes further medical treatment at a MTF. This choice is captured in the parameter  $MT_{GD}$ , which can have the values “SABA” (self-aid/buddy aid) or “FMT” (further medical treatment). The default value is FMT. Using SABA may be warranted in MASCAL scenarios where it is anticipated that insufficient resources will be available. When  $Flag_{MT} = \text{Yes}$ , it is assumed that all personnel have taken pyridostigmine bromide (PB) pretreatment.

5. For inhaled GD, Table 4-7 summarizes the toxicity parameters and associated symptoms, Table 4-8 fully describes the associated Injury Profiles, and Table 4-9 describes the outcomes associated with medical treatment.

**Table 4-7: Inhaled GD Toxicity Parameters and Symptoms**

Injury Profile Label	ECT <sub>50</sub> [mg-min/m <sup>3</sup> ]	Probit Slope [probits/log(dose)]	TLE	Associated Symptoms
Mild	0.2	4.5	1.4	Miosis; rhinorrhea; transient chest tightness
Moderate	0.6	12	1.5	Rhinorrhea; blurred vision or eye pain with sensitivity to light; mild headache; excessive airway secretions induce frequent cough; nausea
Severe	25	12	1.5	Increased secretions and eye effects; vomiting; abdominal cramps; severe headache with anxiety and confusion; tight chest; twitching; weakness; diarrhea; convulsions
Very Severe	33	12	1.5	Collapse; respiratory failure; death without (and maybe in spite of) medical intervention

**Table 4-8: Inhaled GD Injury Profiles**

Time Point [min]	Injury Profile			
	Mild	Moderate	Severe	Very Severe
1	0	2	3	4
3	1	2	3	4
15	1	2	3	4*
150	0	2	3	
1000	0	2	2	
1940	0	1	2	
8640	0	1	1	

\* According to the default value for  $T_{death-CN-SL4}$ , death would be modeled at this point.

**Table 4-9: GD Medical Treatment Outcome Reporting**

Injury Profile	DOW <sup>*</sup>	CONV <sup>*</sup>	RTD <sup>*</sup>
Mild	0%	Day 2: 100%	Day 8: 100%
Moderate	0%	Day 3: 100%	Day 15: 100%
Severe	0%	Day 4: 50% Day 5: 50%	Day 31: 100%
If MT <sub>GD</sub> = SABA (PB pretreatment + self-aid/buddy aid)			
Very Severe, $X_{GD,ih}^{eff} < 100$	0%	Day 15: 100% <sup>†</sup>	0%
Very Severe, $X_{GD,ih}^{eff} \geq 100$	Day 2: 100%	0%	0%
If MT <sub>GD</sub> = FMT (PB pretreatment + self-aid/buddy aid + further medical treatment)			
Very Severe, $X_{GD,ih}^{eff} < 165$	0%	Day 15: 100% <sup>†</sup>	0%
Very Severe, $X_{GD,ih}^{eff} \geq 165$	Day 2: 100%	0%	0%

\* Reported values indicate the fraction that changes status on a given day; they are not cumulative.

† In the personnel status table, these individuals are reported as WIA(3) on Day 2 and remain there until becoming CONV.

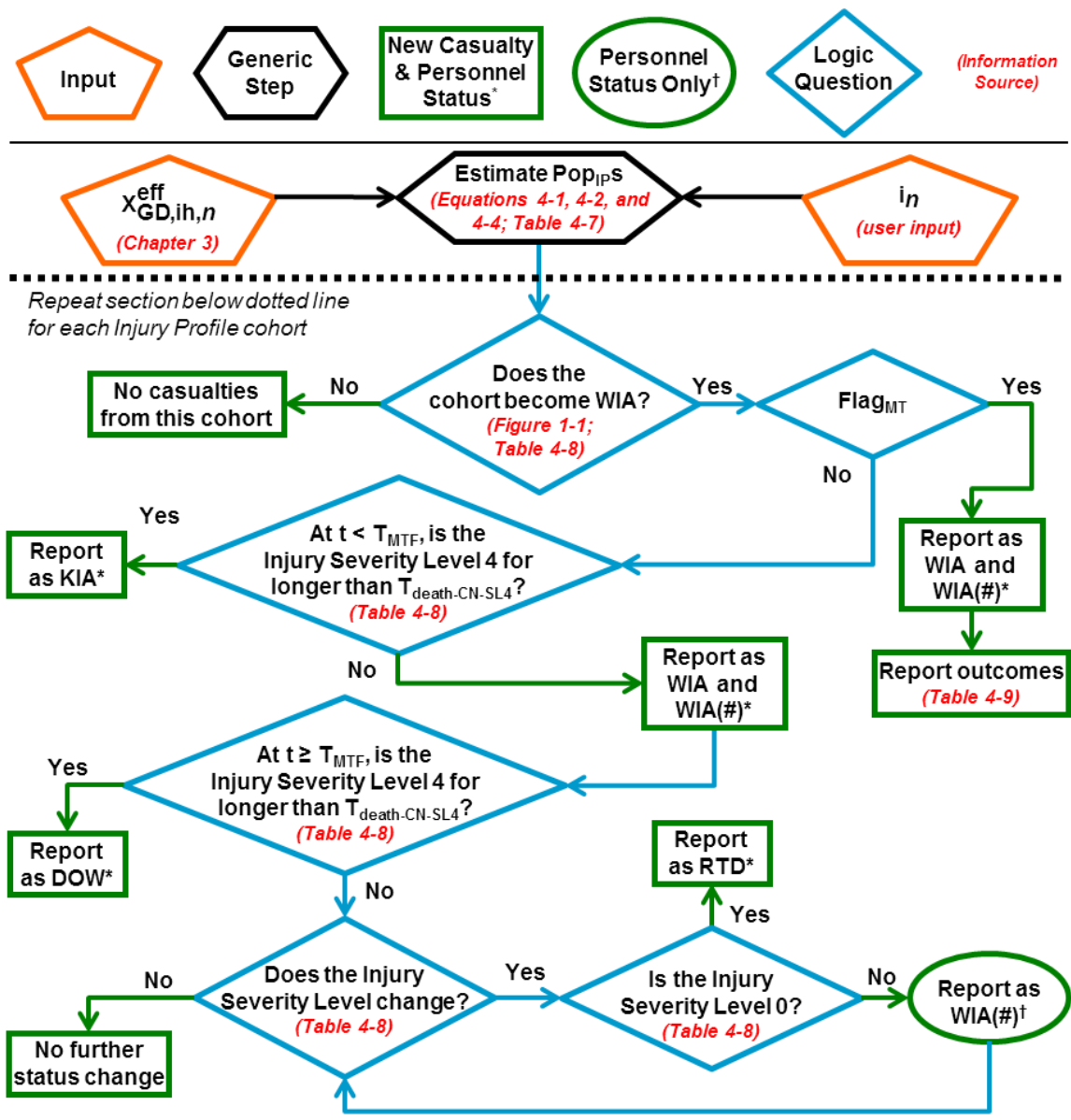

\* Casualty information ( $Pop_{IP}$ ,  $CAT$ ,  $f_{new-CAT}$ ,  $f_{ex-CAT}$ , and  $d$ ) is passed to Equations 4-17 and 4-19.  
 † Personnel status information ( $Pop_{IP}$ ,  $CAT$ ,  $f_{new-CAT}$ ,  $f_{ex-CAT}$ , and  $d$ ) is passed to Equation 4-19.

**Figure 4-5: Human Response Casualty Estimation Flowchart for GD**

**4.2.5. GF**

1. Figure 4-6 summarizes the human response and casualty estimation processes for GF.
2. Assumption and limitation.
  - a. Assumption. Percutaneous exposure to GF vapor is negligible.
  - b. Limitation. Percutaneous exposure to GF liquid is not included; note, however, that the GF percutaneous liquid threat is not negligible.

3. Inhalation is the only GF challenge type considered. Each icon's inhaled  $Ct$  ( $X_{GF,ih,n}^{eff}$ ) is estimated according to Chapter 3.

4. Special consideration for GF. If  $Flag_{MT} = \text{Yes}$ , the user must further specify whether the available medical treatment includes only self-aid and buddy aid (individual issue autoinjectors), or if it also includes further medical treatment at a MTF. This choice is captured in the parameter  $MT_{GF}$ , which can have the values "SABA" (self-aid/buddy aid) or "FMT" (further medical treatment). The default value is FMT. Using SABA may be warranted in MASCAL scenarios where it is anticipated that insufficient resources will be available.

5. For inhaled GF, Table 4-10 summarizes the toxicity parameters and associated symptoms, Table 4-11 fully describes the associated Injury Profiles, and Table 4-12 describes the outcomes associated with medical treatment.

**Table 4-10: Inhaled GF Toxicity Parameters and Symptoms**

Injury Profile Label	$ECt_{50}$ [mg-min/m <sup>3</sup> ]	Probit Slope [probits/log(dose)]	TLE	Associated Symptoms
Mild	0.4	4.5	1.4	Miosis; rhinorrhea; transient chest tightness
Moderate	1.2	12	1.25	Rhinorrhea; blurred vision or eye pain with sensitivity to light; mild headache; excessive airway secretions induce frequent cough; nausea
Severe	31	12	1.25	Increased secretions and eye effects; vomiting; abdominal cramps; severe headache with anxiety and confusion; tight chest; twitching; weakness; diarrhea; convulsions
Very Severe	41	12	1.25	Collapse; respiratory failure; death without (and maybe in spite of) medical intervention

**Table 4-11: Inhaled GF Injury Profiles**

Time Point [min]	Injury Profile			
	Mild	Moderate	Severe	Very Severe
1	0	2	3	4
3	1	2	3	4
15	1	2	3	4*
150	0	2	3	
1000	0	2	2	
1940	0	1	2	
8640	0	1	1	

\* According to the default value for  $T_{\text{death-CN-SL4}}$ , death would be modeled at this point.

**Table 4-12: GF Medical Treatment Outcome Reporting**

Injury Profile	DOW*	CONV*	RTD*
Mild	0%	Day 2: 100%	Day 8: 100%
Moderate	0%	Day 3: 100%	Day 15: 100%
Severe	0%	Day 4: 50% Day 5: 50%	Day 31: 100%
If MT <sub>GF</sub> = SABA (self-aid/buddy aid only)			
Very Severe, X <sub>GF,ih</sub> <sup>eff</sup> < 123	0%	Day 15: 100%†	0%
Very Severe, X <sub>GF,ih</sub> <sup>eff</sup> ≥ 123	Day 2: 100%	0%	0%
If MT <sub>GF</sub> = FMT (self-aid/buddy aid + further medical treatment)			
Very Severe, X <sub>GF,ih</sub> <sup>eff</sup> < 205	0%	Day 15: 100%†	0%
Very Severe, X <sub>GF,ih</sub> <sup>eff</sup> ≥ 205	Day 2: 100%	0%	0%

\* Reported values indicate the fraction that changes status on a given day; they are not cumulative.

† In the personnel status table, these individuals are reported as WIA(3) on Day 2 and remain there until becoming CONV.

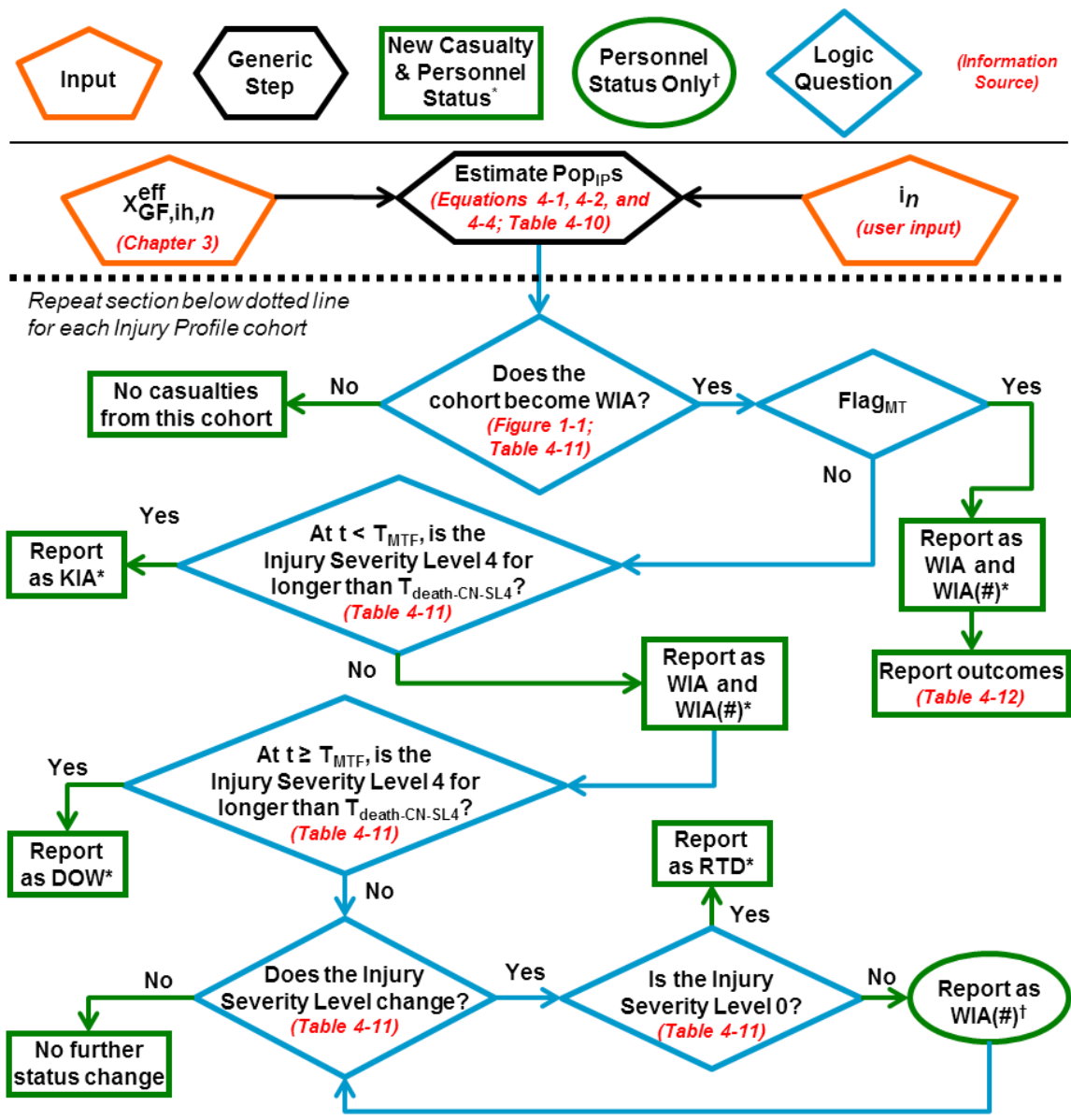

**Figure 4-6: Human Response Casualty Estimation Flowchart for GF**

**4.2.6. VX**

1. Figure 4-7 summarizes the human response and casualty estimation processes for VX.
2. Assumption and limitation.
  - a. Assumption. Human response due to inhaled VX and percutaneous VX liquid are independent of one another—the effects of each challenge type are modeled separately and only combined in the form of a Composite Injury Profile.

- b. Limitation. Percutaneous exposure to VX vapour is not included; note, however, that the VX percutaneous vapour threat is not negligible.
3. Inhalation and percutaneous liquid are the challenge types considered for VX. Each icon's inhaled Ct ( $X_{VX,ih,n}^{eff}$ ) and percutaneous liquid dose ( $X_{VX,pc,n}^{eff}$ ) are estimated according to Chapter 3.
4. Special consideration for VX. If  $Flag_{MT} = \text{Yes}$ , the user must further specify whether the available medical treatment includes only self-aid and buddy aid (individual issue autoinjectors), or if it also includes further medical treatment at a MTF. This choice is captured in the parameter  $MT_{VX}$ , which can have the values "SABA" (self-aid/buddy aid) or "FMT" (further medical treatment). The default value is FMT. Using SABA may be warranted in MASCAL scenarios where it is anticipated that insufficient resources will be available.
5. For inhaled VX, Table 4-13 summarizes the toxicity parameters and associated symptoms and Table 4-14 fully describes the associated Injury Profiles. Likewise, Table 4-15 and Table 4-16 describe the toxicity parameters, symptoms, Injury Profiles for percutaneous VX liquid. Finally, Table 4-17 describes the outcomes associated with medical treatment.

**Table 4-13: Inhaled\* VX Toxicity Parameters and Symptoms**

Injury Profile Label	EC <sub>t50</sub> [mg-min/m <sup>3</sup> ]	Probit Slope [probits/log(dose)]	TLE	Associated Symptoms
Mild	0.04	4.5	1.4	Miosis; rhinorrhea; transient chest tightness
Moderate	0.36	12	1	Rhinorrhea; blurred vision or eye pain with sensitivity to light; mild headache; excessive airway secretions induce frequent cough; nausea
Severe	9	12	1	Increased secretions and eye effects; vomiting; abdominal cramps; severe headache with anxiety and confusion; tight chest; twitching; weakness; diarrhea; convulsions
Very Severe	12	12	1	Collapse; respiratory failure; death without (and maybe in spite of) medical intervention

\* Ocular effects are also included in the Injury Profiles—note that the Associated Symptoms include ocular symptoms.

**Table 4-14: Inhaled\* VX Injury Profiles**

Time Point [min]	Injury Profile			
	Mild	Moderate	Severe	Very Severe
1	0	2	3	4
3	1	2	3	4
15	1	2	3	4 <sup>†</sup>
150	0	2	3	
1000	0	2	2	
1940	0	1	2	

Time Point [min]	Injury Profile			
	Mild	Moderate	Severe	Very Severe
8640	0	1	1	

\* Ocular effects are also included in the Injury Profiles (see symptoms in Table 4-13).

† According to the default value for  $T_{\text{death-CN-SL4}}$ , death would be modeled at this point.

**Table 4-15: Percutaneous VX Liquid Toxicity Parameters and Symptoms**

Injury Profile Label	ED <sub>50</sub> [mg]	Probit Slope [probits/log(dose)]	TLE	Associated Symptoms
Moderate	1.2	6	1	Muscle twitching; chest tightness and shortness of breath; episodes of vomiting
Severe	2	6	1	Severe generalized trembling with possible convulsions; feelings of confusion and anxiety; respiratory congestion and bronchorrhea
Very Severe	3	5.5	1	Unconsciousness; paralysis; breathing stops completely or struggling to breathe

**Table 4-16: Percutaneous VX Liquid Injury Profiles**

Time Point [min]	Injury Profile			Time Point [min]	Injury Profile		
	Moderate	Severe	Very Severe		Moderate	Severe	Very Severe
1	0	0	0	100	1	2	
8	0	1	1	150	1	3	
10	1	1	1	360	2	3	
30	1	1	2	1000	1	3	
36	1	1	4	1440	0	3	
51	1	1	4*	2400	0	2	

\* According to the default value for  $T_{\text{death-CN-SL4}}$ , death would be modeled at this point.

6. Medical treatment-related outcomes for icons challenged via both inhalation and percutaneous liquid are dictated by the more severe challenge, where the severity of the challenge increases as one moves down the rows in Table 4-17.

**Table 4-17: VX Medical Treatment Outcome Reporting**

Inhalation Injury Profile	Percutaneous Injury Profile	DOW*	CONV*	RTD*
Mild	(n/a)	0%	Day 2: 100%	Day 8: 100%
Moderate	Moderate	0%	Day 3: 100%	Day 15: 100%
Severe	Severe	0%	Day 4: 50% Day 5: 50%	Day 31: 100%
If $MT_{\text{VX}} = \text{SABA}$ (self-aid/buddy aid only)				
Very Severe, $X_{\text{VX,ih}}^{\text{eff}} < 36$	Very Severe, $X_{\text{VX,pc,n}}^{\text{eff}} < 9$	0%	Day 15: 100%†	0%
Very Severe, $X_{\text{VX,ih}}^{\text{eff}} \geq 36$	Very Severe, $X_{\text{VX,pc,n}}^{\text{eff}} < 9$	Day 2: 100%	0%	0%
If $MT_{\text{VX}} = \text{FMT}$ (self-aid/buddy aid + further medical treatment)				
Very Severe, $X_{\text{VX,ih}}^{\text{eff}} < 60$	Very Severe, $X_{\text{VX,pc,n}}^{\text{eff}} < 15$	0%	Day 15: 100%†	0%
Very Severe, $X_{\text{VX,ih}}^{\text{eff}} \geq 60$	Very Severe, $X_{\text{VX,pc,n}}^{\text{eff}} < 15$	Day 2: 100%	0%	0%

\* Reported values indicate the fraction that changes status on a given day; they are not cumulative.

† In the personnel status table, these individuals are reported as WIA(3) on Day 2 and remain there until becoming CONV.



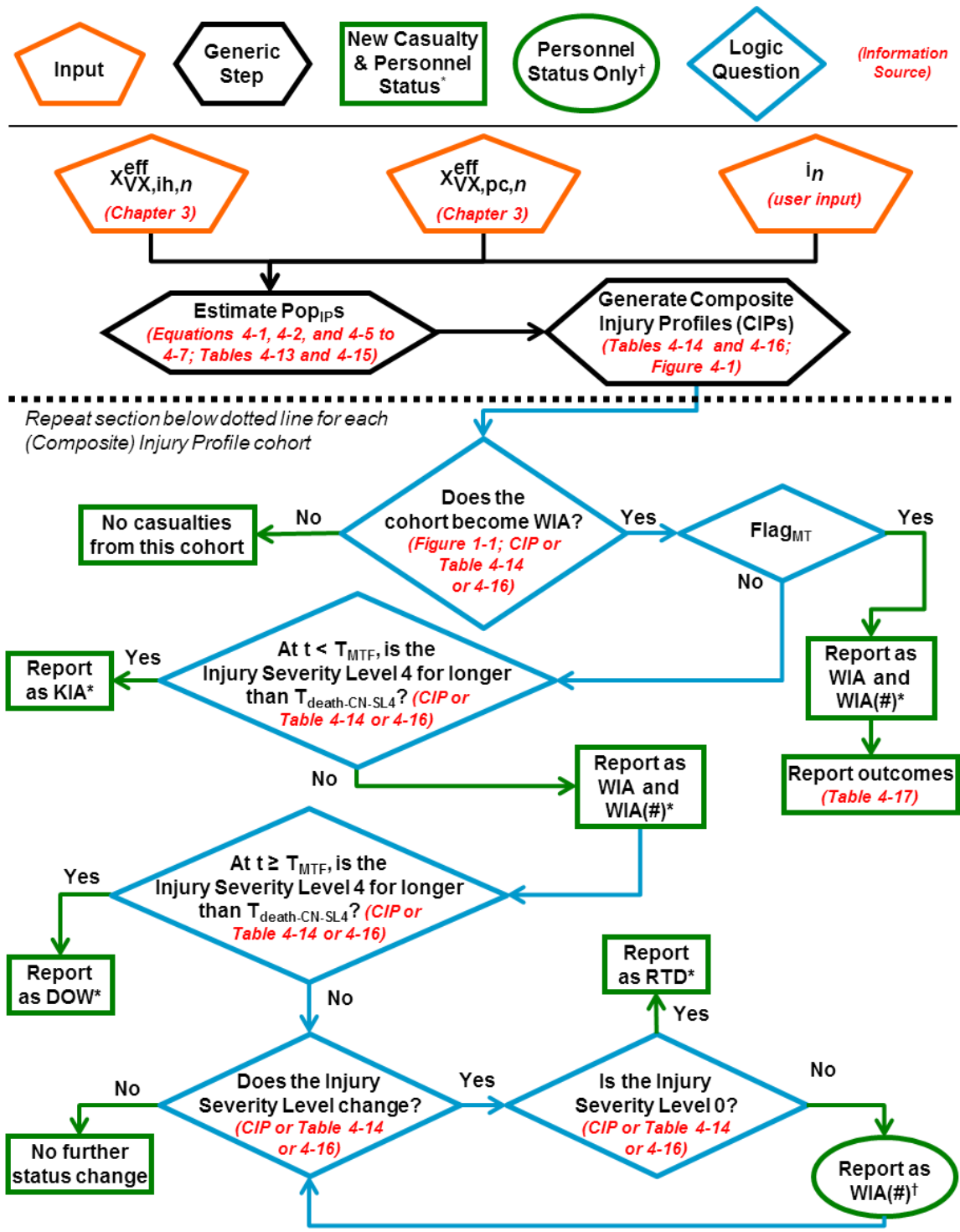

\* Casualty information (Pop<sub>IP</sub>, CAT,  $f_{new-CAT}$ ,  $f_{ex-CAT}$ , and d) is passed to Equations 4-17 and 4-19.

† Personnel status information (Pop<sub>IP</sub>, CAT,  $f_{new-CAT}$ ,  $f_{ex-CAT}$ , and d) is passed to Equation 4-19.

Figure 4-7: Human Response and Casualty Estimation Flowchart for VX

#### 4.2.7. HD

1. Figure 4-8 summarizes the human response and casualty estimation processes for HD.
2. Assumption. Human response due to inhaled HD, percutaneous HD vapour, and percutaneous HD liquid are independent of one another—the effects of each challenge type are modeled separately and only combined in the form of Composite Injury Profiles and the Equivalent Percutaneous Vapour challenge type.
3. Inhalation, ocular vapour, and equivalent percutaneous vapour (which contains contributions from percutaneous liquid and percutaneous vapour—see Table 2-2) are the challenge types considered for HD.
  - a. Each icon's inhaled Ct ( $X_{HD,ih,n}^{eff}$ ) is estimated according to Chapter 3.
  - b. Each icon's ocular vapour Ct ( $X_{HD,oc,n}^{eff}$ ) is estimated according to Chapter 3, using percutaneous vapour data as input; the ocular vapour Ct is considered equivalent to the percutaneous vapour Ct.
  - c. Each icon's equivalent percutaneous vapour Ct ( $X_{HD,epc,k,n}^{eff}$ ) is estimated using both percutaneous vapour and percutaneous liquid input data, according to Equation 4-21.<sup>62</sup> Because Equation 4-21 contains a term whose value depends upon the health effect being considered (lethal or mild/severe), the symbol for equivalent percutaneous vapour Ct contains  $k$  in its subscript. Further,  $X_{HD,epc,lethal,n}^{eff}$  and  $X_{HD,epc,mild/severe,n}^{eff}$  must both be computed, and each must be used appropriately when calculating the populations of Injury Profile cohorts in accordance with Section 4.1.2.

$$X_{HD,epc,k,n}^{eff} = X_{HD,pv,n}^{eff} + X_{HD,pl,n}^{eff} \cdot CF_{HD,k}, \quad (4-21)$$

where:

$X_{HD,epc,k,n}^{eff}$  is the equivalent percutaneous vapour Ct for icon  $n$  [mg-min/m<sup>3</sup>],

$X_{HD,pv,n}^{eff}$  is the percutaneous vapour Ct for icon  $n$  as calculated according to Chapter 3 [mg-min/m<sup>3</sup>],

$X_{HD,pl,n}^{eff}$  is the percutaneous liquid dose for icon  $n$  as calculated according to Chapter 3 [mg], and

$CF_{HD,k}$  is the percutaneous liquid to equivalent vapour conversion factor for

<sup>62</sup> Gene E. McClellan, George H. Anno, and Leigh N. Matheson, *Consequence Analytic Tools for NBC Operations Volume 3: Chemical Agent Exposure and Casualty Estimation* (Alexandria, VA: Defense Special Weapons Agency, 1998), 32–35.

HD [(mg-min/m<sup>3</sup>) / (mg)], as defined in Equation 4-22.<sup>63</sup>

$$CF_{HD,k} = \frac{\text{vapour toxicity}}{\text{liquid toxicity}}, \quad (4-22)$$

where:

$k$  can be “lethal” or “mild/severe”,

vapour toxicity is either the EC<sub>50-severe</sub> (when  $k$  is “mild/severe”) or the LC<sub>50</sub> (when  $k$  is “lethal”) listed in Table 4-18, and

liquid toxicity is either the ED<sub>50-severe</sub> (when  $k$  is “mild/severe”) or the LD<sub>50</sub> (when  $k$  is “lethal”) listed in Table 4-18.

**Table 4-18: Recommended Parameter Values for Equivalent Vapour Conversion Factors for HD (CF<sub>HD,k</sub>)**

Toxicity Parameter	Recommended Parameter Value*
EC <sub>50-severe</sub> (percutaneous vapour)	500 mg-min/m <sup>3</sup> † 200 mg-min/m <sup>3</sup> §
ED <sub>50-severe</sub> (percutaneous liquid)	600 mg
LC <sub>50</sub> (percutaneous vapour)	10,000 mg-min/m <sup>3</sup> † 5,000 mg-min/m <sup>3</sup> §
LD <sub>50</sub> (percutaneous liquid)	1,400 mg

\* U.S. Army Chemical School (USACMLS), *Potential Military Chemical/Biological Agents and Compounds*, FM 3-11.9/MCRP 3-37.1B/NTRP 3-11.32/AFTTP(I) 3-2.55 (Washington, DC: U.S. Government Printing Office, January 2005), II-40.

† Value to be used for temperatures between 18.33 and 29.44 °C (65 and 85 °F).

§ Value to be used for temperatures above 29.44 °C (85 °F).

4. Special consideration for HD. The percutaneous vapor toxicity values used for calculating the equivalent vapor conversion factor and for assigning individuals to Injury Profiles are dependent on temperature. The ranges to which each value applies are specified in notes for Table 4-18 and Table 4-23. The user must determine which values should be used based on the scenario being modeled.

5. For inhaled HD, Table 4-19 summarizes the toxicity parameters and associated symptoms and Table 4-20 fully describes the associated Injury Profiles. Likewise, Table 4-21 and Table 4-22 describe the symptoms and Injury Profiles for ocular HD vapour, and Table 4-23 and Table 4-24 describe the symptoms and Injury Profiles for equivalent percutaneous HD vapour. Finally, Table 4-25 describes the outcomes associated with medical treatment.

<sup>63</sup> Equation generalized from McClellan, Anno, and Matheson, *Consequence Analytic Tools for NBC Operations Volume 3: Chemical Agent Exposure and Casualty Estimation*, 32–35.

**Table 4-19: Inhaled HD Toxicity Parameters and Symptoms**

Injury Profile Label	EC <sub>50</sub> [mg-min/m <sup>3</sup> ]	Probit Slope [probits/log(dose)]	TLE	Associated Symptoms
IH Mild, $X_{HD,ih}^{eff} < 70$	73	6	1.5	Nauseated; swallows often
IH Mild, $X_{HD,ih}^{eff} \geq 70$				Dry mouth; dry cough; sneezing; runny nose; headache; nauseated; vomited once or twice
IH Moderate	146	6	1.5	Sore throat; continuous cough; hoarseness; chest feels tight; headache; fever
IH Severe	220	6	1.5	Hurts to breathe; hacking cough; cannot speak; headache; dry heaves; fatigued from vomiting
IH Very Severe, $X_{HD,ih}^{eff} < 1200$	1000	6	1.5	Awful chest pain; wheezing and shortness of breath; coughs up red colored mucous
IH Very Severe, $X_{HD,ih}^{eff} \geq 1200$				

**Table 4-20: Inhaled HD Injury Profiles**

Time Point [hr]	Injury Profile					
	Mild $X_{HD,ih}^{eff} < 70$	Mild $X_{HD,ih}^{eff} \geq 70$	Moderate	Severe	Very Severe $X_{HD,ih}^{eff} < 1200$	Very Severe $X_{HD,ih}^{eff} \geq 1200$
1	0	0	0	1	1	1
4	0	0	0	1	2	2
6	0	1	1	2	2	2
8	1	1	1	2	2	2
20	0	1	1	2	2	2
24	0	1	1	2	3	3
36	0	1	2	3	3	3
48	0	1	2	3	3	4*
72	0	1	2	3	4*	
168	0	0	2	3		
336	0	0	1	2		
720	0	0	0	1		
1008	0	0	0	0		

\* According to the default value for  $T_{death-CN-SL4}$ , death would be modeled at this point.

**Table 4-21: Ocular HD Vapour Toxicity Parameters and Symptoms**

Injury Profile Label	EC <sub>50</sub> [mg-min/m <sup>3</sup> ]	Probit Slope [probits/log(dose)]	TLE	Associated Symptoms
OC Moderate, $X_{HD,oc}^{eff} < 26$	25	3	1	Eyes sting; tears; blurred vision; miosis; blepharospasm; conjunctival erythema
OC Moderate, $X_{HD,oc}^{eff} \geq 26$ and $< 50$				
OC Moderate, $X_{HD,oc}^{eff} \geq 50$				Eyes feel gritty and sensitive to light; non-stop tears flood eyes; miosis
OC Severe	75	3	1	Eyelids are swollen shut and burning; eyes are too painful to open

**Table 4-22: Ocular HD Vapour Injury Profiles**

Time Point [hr]	Injury Profile			
	Moderate $X_{HD,oc}^{eff} < 26$	Moderate $X_{HD,oc}^{eff} \geq 26$ and $< 50$	Moderate $X_{HD,oc}^{eff} \geq 50$	Severe
1	0	0	0	0
3	0	0	0	1
4	0	0	1	2
5	0	1	1	2
6	0	1	2	2
9	1	1	2	2
12	1	2	2	3
18	2	2	2	3
36	1	2	2	3
60	0	1	2	3
108	0	0	2	3
168	0	0	2	2
504	0	0	1	1
672	0	0	0	0

**Table 4-23: Equivalent Percutaneous HD Vapour Toxicity Parameters and Symptoms**

Injury Profile Label	EC <sub>t50</sub> [mg-min/m <sup>3</sup> ]	Probit Slope [probits/log(dose)]	TLE	Associated Symptoms
EPC Mild, $X_{HD,epc}^{eff} < 125$	50* 25†	3	1	Skin sensitive to touch in tender areas (crotch, armpits, inside of elbow and knee)
EPC Mild, $X_{HD,epc}^{eff} \geq 125$				Skin sore in tender areas; painful when moving; redness of the skin; tiny blisters on hands and neck
EPC Severe	500* 200†	3	1	Skin peels off leaving open raw areas and painful ulcers in tender areas
EPC Very Severe	10,000* 5,000†	7	1	Skin symptoms from above, plus eventual death due to secondary effects related to bone marrow stem cell depression

\* Value to be used for temperatures between 18.33 and 29.44 °C (65 and 85 °F).

† Value to be used for temperatures above 29.44 °C (85 °F).

**Table 4-24: Equivalent Percutaneous HD Vapour Injury Profiles**

Time Point [hr]	Injury Profile			
	Mild $X_{HD,epc}^{eff} < 125$	Mild $X_{HD,epc}^{eff} \geq 125$	Severe	Very Severe
1	0	0	0	0
2	0	0	1	1
5	0	0	2	2
18	0	1	2	2
24	0	1	3	3
36	1	1	3	3
96	0	1	3	3
168	0	0	3	3
336	0	0	3	4*
504	0	0	1	
588	0	0	0	

\* Death is modeled at this point regardless of the values of the various methodology parameters.

Table 4-25: HD Medical Treatment Outcome Reporting

Injury Profile	DOW*	CONV*	RTD*
<b>Inhalation Injury Profiles</b>			
IH Mild, $X_{HD,ih}^{eff} < 70$	0%	0%	Day 2: 100%
IH Mild, $X_{HD,ih}^{eff} \geq 70$	0%	0%	Day 4: 20% Day 5: 20% Day 6: 20% Day 7: 20% Day 8: 20%
IH Moderate	0%	Day 14: 27% Day 21: 73%	0%
IH Severe	0%	Day 28: 50% Day 35: 50%	0%
IH Very Severe, $X_{HD,ih}^{eff} < 1200$	Day 7: 14% Day 14: 24.5% Day 21: 24.5% Day 28: 24.5%	Day 35: 12.5%	0%
IH Very Severe, $X_{HD,ih}^{eff} \geq 1200$	Day 3: 100%	0%	0%
<b>Ocular Injury Profiles</b>			
OC Moderate $X_{HD,oc}^{eff} < 26$	0%	0%	Day 2: 50% Day 3: 50%
OC Moderate, $X_{HD,oc}^{eff} \geq 26$ and $< 50$	0%	Day 4: 50% Day 5: 50%	0%
OC Moderate $X_{HD,oc}^{eff} \geq 50$	0%	Day 7: 22% Day 14: 78%	0%
OC Severe	0%	Day 21: 50% Day 28: 50%	0%
<b>Equivalent Percutaneous Injury Profiles</b>			
EPC Mild $X_{HD,epc}^{eff} < 125$	0%	0%	Day 3: 33% Day 4: 33% Day 5: 34%
EPC Mild $X_{HD,epc}^{eff} \geq 125$	0%	Day 6: 33% Day 7: 33% Day 8: 34%	0%
EPC Severe	0%	Day 21: 64% Day 28: 36%	0%
EPC Very Severe	Day 10: 8%	Day 28: 36% Day 35: 14% Day 42: 14% Day 49: 14% Day 56: 14%	0%

\* Reported values indicate the fraction that changes status on a given day; they are not cumulative.

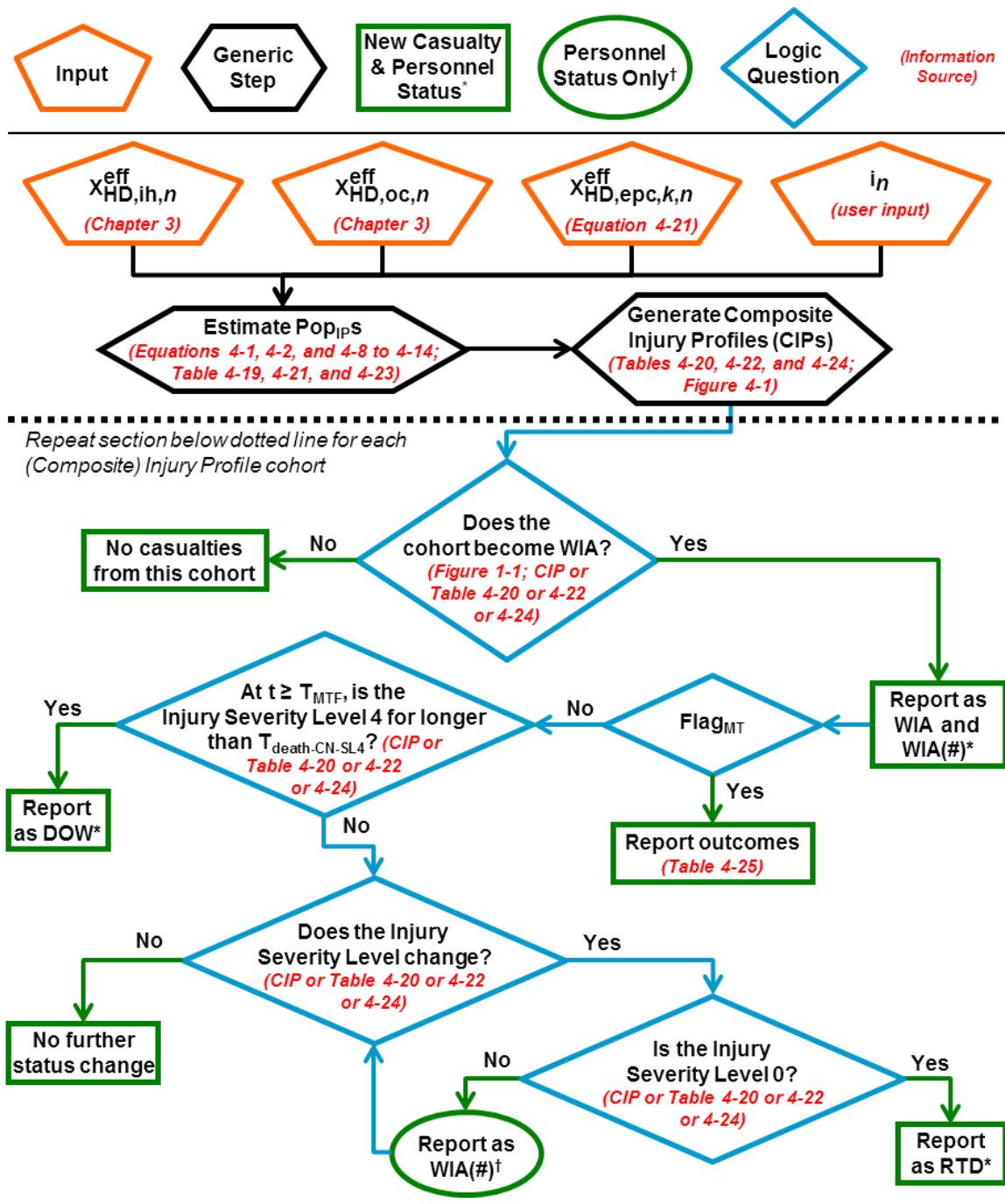

\* Casualty information ( $Pop_{IP}$ , CAT,  $f_{new-CAT}$ ,  $f_{ex-CAT}$ , and d) is passed to Equations 4-17 and 4-19.  
 † Personnel status information ( $Pop_{IP}$ , CAT,  $f_{new-CAT}$ ,  $f_{ex-CAT}$ , and d) is passed to Equation 4-19.

**Figure 4-8: Human Response and Casualty Estimation Flowchart for HD**



#### 4.2.8. CG

1. Figure 4-9 summarizes the human response and casualty estimation processes for CG.
2. Assumption. Percutaneous exposure to CG vapour and liquid are negligible.
3. Two inhalation CG challenge types are considered. Each icon's inhaled Ct ( $X_{CG,ih,n}^{eff}$ ) and peak concentration ( $X_{CG,[ih],n}^{eff}$ ) are estimated according to Chapter 3.
4. For inhaled CG Ct-based effects, Table 4-26 summarizes the toxicity parameters and associated symptoms and Table 4-27 fully describes the associated Injury Profiles. Likewise, Table 4-28 and Table 4-29 describe the symptoms and Injury Profiles for inhaled CG concentration-based effects. Finally, Table 4-30 describes the outcomes associated with medical treatment.

**Table 4-26: Inhaled CG Toxicity Parameters and Symptoms**

Injury Profile Label	ECt <sub>50</sub> [mg-min/m <sup>3</sup> ]	Probit Slope [probits/log(dose)]	TLE	Associated Symptoms
Severe	250	11.0	1	Pulmonary edema (progressive respiratory distress; anxiety; dry and then painful wet cough; chest pain; nausea and vomiting)
Very Severe	1500	11.0	1	More severe and rapidly progressing pulmonary edema (progressive respiratory distress; anxiety; dry and then painful wet cough; chest pain; nausea and vomiting; loss of consciousness)

**Table 4-27: Inhaled CG Injury Profiles**

Time Point [min]	Injury Profile	
	Severe	Very Severe
1	0	0
240	0	3
360	0	4*
720	3	
870	4*	

\* According to the default value for T<sub>death-CN-SL4</sub>, death would be modeled at this point.

**Table 4-28: Peak CG Concentration Ranges**

Peak Concentration Range [mg/m <sup>3</sup> ]	Description
< 12	No observable injury
≥ 12	Nausea; transient irritation to the eyes, nose and throat; anxiety; shortness of breath; mild dry cough

**Table 4-29: Peak CG Concentration Injury Profile**

Time Point [min]	Injury Profile ≥ 12 mg/m <sup>3</sup>
1	1
15	0

**Table 4-30: CG Medical Treatment Outcome Reporting**

Injury Profile	DOW <sup>*</sup>	CONV <sup>*</sup>	RTD <sup>*</sup>
> 12 mg/m <sup>3</sup>	0%	0%	Day 2: 100%
Severe	0%	Day 14: 2% <sup>†</sup> Day 21: 7% <sup>†</sup> Day 28: 12% <sup>†</sup> Day 35: 17% <sup>†</sup> Day 42: 22% <sup>†</sup> Day 49: 25% <sup>†</sup> Day 56: 13% <sup>†</sup> Day 60: 2% <sup>†</sup>	Day 90: 100%
Very Severe	Day 2: 100%	0%	0%

\* Reported values indicate the fraction that changes status on a given day; they are not cumulative.

† In the personnel status table, these individuals are reported as WIA(3) on Day 2 and remain there until becoming CONV.

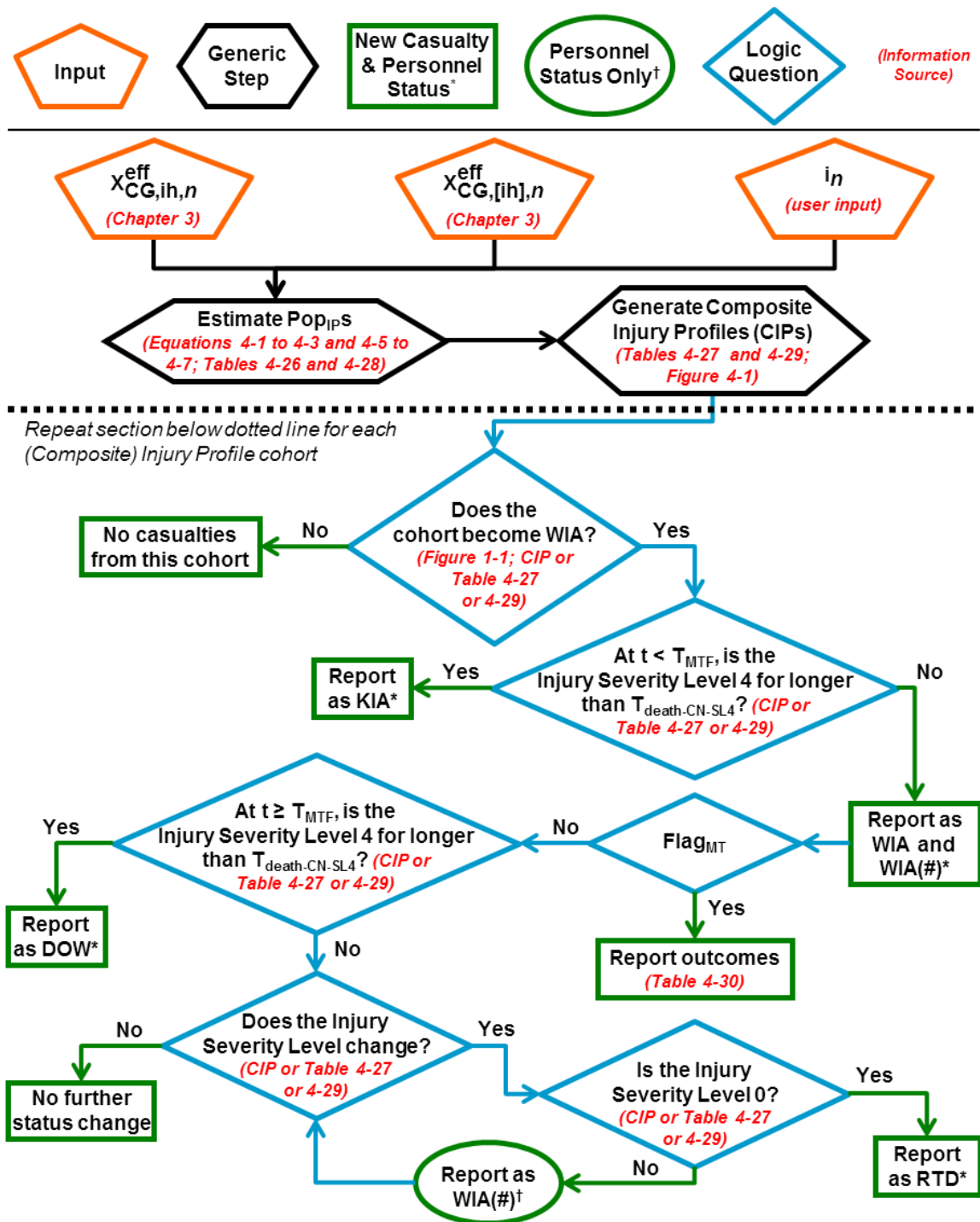

\* Casualty information (Pop<sub>IP</sub>, CAT,  $f_{new-CAT}$ ,  $f_{ex-CAT}$ , and d) is passed to Equations 4-17 and 4-19.  
 † Personnel status information (Pop<sub>IP</sub>, CAT,  $f_{new-CAT}$ ,  $f_{ex-CAT}$ , and d) is passed to Equation 4-19.

Figure 4-9: Human Response and Casualty Estimation Flowchart for CG

#### 4.2.9. Cl<sub>2</sub>

- Figure 4-10 summarizes the human response and casualty estimation processes for Cl<sub>2</sub>.
- Assumption. Percutaneous exposure to Cl<sub>2</sub> vapour and liquid are negligible.
- Inhalation is the only Cl<sub>2</sub> challenge type considered. Each icon's inhaled Ct ( $X_{Cl_2,ih,n}^{eff}$ ) is estimated according to Chapter 3.
- For inhaled Cl<sub>2</sub>, Table 4-31 summarizes the toxicity parameters and associated symptoms, Table 4-32 fully describes the associated Injury Profiles, and Table 4-33 describes the outcomes associated with medical treatment.

**Table 4-31: Inhaled Cl<sub>2</sub> Toxicity Parameters and Symptoms**

Injury Profile Label	EC <sub>50</sub> [mg-min/m <sup>3</sup> ]	Probit Slope [probits/log(dose)]	TLE	Associated Symptoms
Mild	70	10.5	2.75	Nausea; desire to vomit; mild eye irritation; mild shortness of breath; chest tightness, slight irritation of nose and throat; cough; minor nasal congestion and runny nose; headache and dizziness
Moderate	325	10.5	2.75	Vomiting; severe eye irritation; moderate shortness of breath; some chest pain; difficulty breathing; more pronounced coughing and irritation of the throat; nasal and respiratory congestion with possible phlegm
Severe	1300	10.5	2.75	Severe shortness of breath; marked chest pain; rapid and restricted breathing; intense coughing; tracheo-bronchitis; delayed onset of pulmonary edema and/or toxic pneumonitis or bronchio-pneumonia
Very Severe	13500	10.5	2.75	Extreme shortness of breath; decreased breath sounds; production of large amounts of frothy liquid; rapid onset of pulmonary edema; coma; death

**Table 4-32: Inhaled Cl<sub>2</sub> Injury Profiles**

Time Point [min]	Injury Profile			
	Mild	Moderate	Severe	Very Severe
1	1	2	2	3
120	1	2	3	4
135	1	2	3	4*
360	0	2	3	
720	0	1	3	
1440	0	0	3	
10080	0	0	0	

\* According to the default value for T<sub>death-CN-SL4</sub>, death would be modeled at this point.

**Table 4-33: Cl<sub>2</sub> Medical Treatment Outcome Reporting**

Injury Profile	DOW*	CONV*	RTD*
Mild	0%	0%	Day 2: 100%
Moderate	0%	0%	Day 2: 100%
Severe	0%	0%	Day 5: 100%
Very Severe	Day 2: 7%	Day 7: 27% <sup>†</sup> Day 14: 22% <sup>†</sup> Day 21: 22% <sup>†</sup> Day 28: 22% <sup>†</sup>	Day 60: 93%

\* Reported values indicate the fraction that changes status on a given day; they are not cumulative.

† In the personnel status table, these individuals are reported as WIA(3) on Day 2 and remain there until becoming CONV.

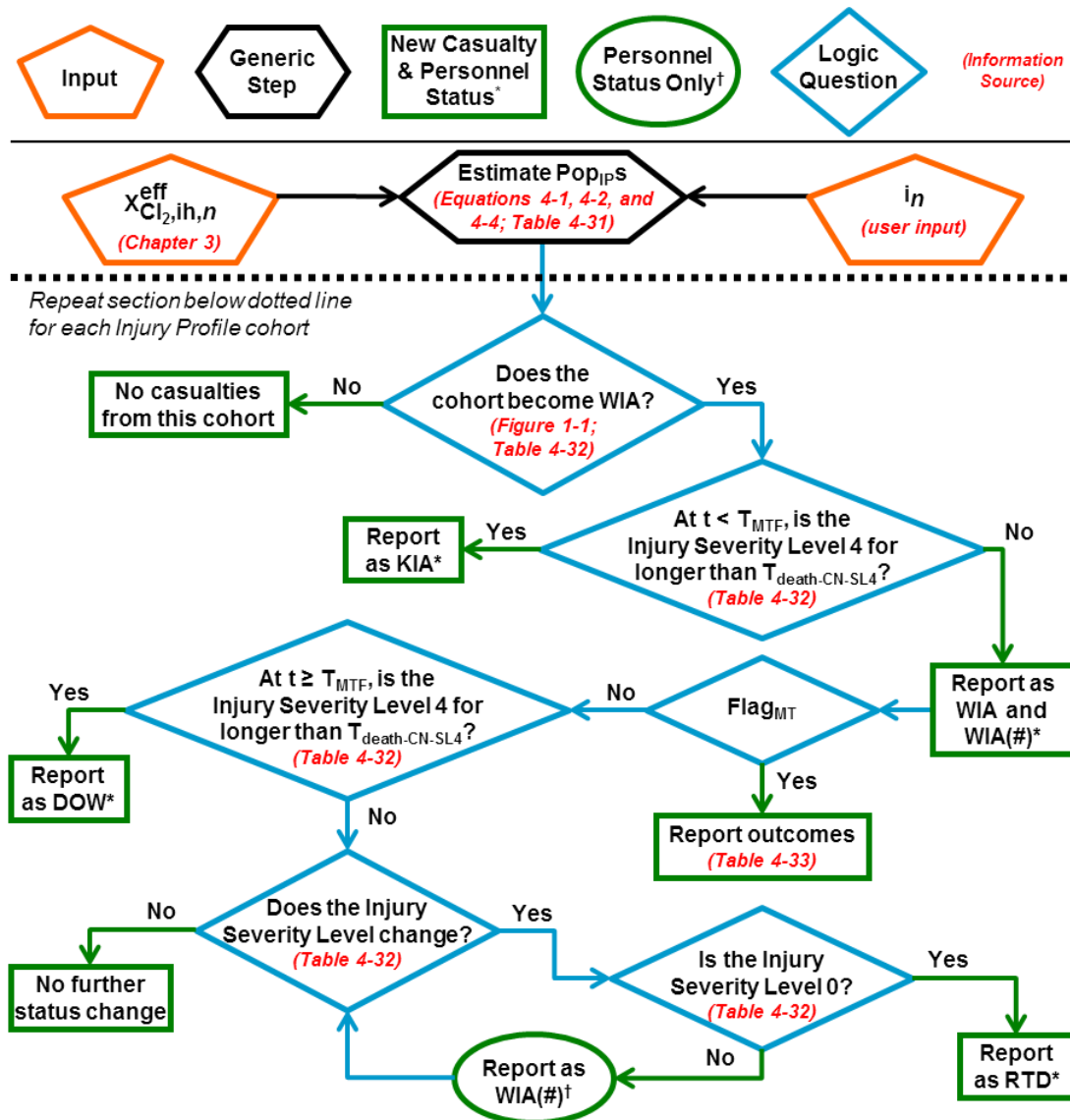

\* Casualty information ( $Pop_{IP}$ ,  $CAT$ ,  $f_{new-CAT}$ ,  $f_{ex-CAT}$ , and  $d$ ) is passed to Equations 4-17 and 4-19.

† Personnel status information ( $Pop_{IP}$ ,  $CAT$ ,  $f_{new-CAT}$ ,  $f_{ex-CAT}$ , and  $d$ ) is passed to Equation 4-19.

**Figure 4-10: Human Response and Casualty Estimation Flowchart for Cl<sub>2</sub>**

#### 4.2.10. NH<sub>3</sub>

- Figure 4-11 summarizes the human response and casualty estimation processes for NH<sub>3</sub>.
- Assumption. Percutaneous exposure to NH<sub>3</sub> vapour and liquid are negligible.
- Inhalation is the only NH<sub>3</sub> challenge type considered. Each icon's inhaled Ct ( $X_{\text{NH}_3, \text{ih}, n}^{\text{eff}}$ ) is estimated according to Chapter 3.
- For inhaled NH<sub>3</sub>, Table 4-34 summarizes the toxicity parameters and associated symptoms, Table 4-35 fully describes the associated Injury Profiles, and Table 4-36 describes the outcomes associated with medical treatment.

**Table 4-34: Inhaled NH<sub>3</sub> Toxicity Parameters and Symptoms**

Injury Profile Label	EC <sub>50</sub> [mg-min/m <sup>3</sup> ]	Probit Slope [probits/log(dose)]	TLE	Associated Symptoms
Mild	350	16.5	2.0	Mild eye irritation; rhinorrhea; cough; sneezing; drooling; dyspnea; headache
Moderate	1000	16.5	2.0	Tear production; burning sensation; blepharospasm; conjunctivitis; photophobia; more pronounced cough; pharyngitis; laryngitis; moderate throat irritation
Severe	7800	16.5	2.0	Corneal ulcerations; iritis; anterior and posterior synechia; corneal opacification; cataracts; glaucoma; retinal atrophy; directly caustic to airway; laryngospasm; bronchospasm; chest pain; loss of consciousness
Very Severe	67700	16.5	2.0	Sloughing and necrosis of airway mucosa; severe chest pain; pulmonary edema; respiratory failure; cerebral edema; seizures; coma; death

**Table 4-35: Inhaled NH<sub>3</sub> Injury Profiles**

Time Point [min]	Injury Profile			
	Mild	Moderate	Severe	Very Severe
1	1	2	2	4
15	1	2	2	4*
360	0	2	2	
720	0	2	3	
4320	0	0	3	
43200	0	0	0	

\* According to the default value for T<sub>death-CN-SL4</sub>, death would be modeled at this point.

**Table 4-36: NH<sub>3</sub> Medical Treatment Outcome Reporting**

Injury Profile	DOW*	CONV*	RTD*
Mild	0	0	Day 2: 100%
Moderate	0	0	Day 3: 100%
Severe	0	0	Day 8: 100%
Very Severe	Day 31: 27%	Day 15: 36%† Day 29: 37%†	Day 91: 73%

\* Reported values indicate the fraction that changes status on a given day; they are not cumulative.  
 † In the personnel status table, these individuals are reported as WIA(3) on Day 2 and remain there until becoming RTD.

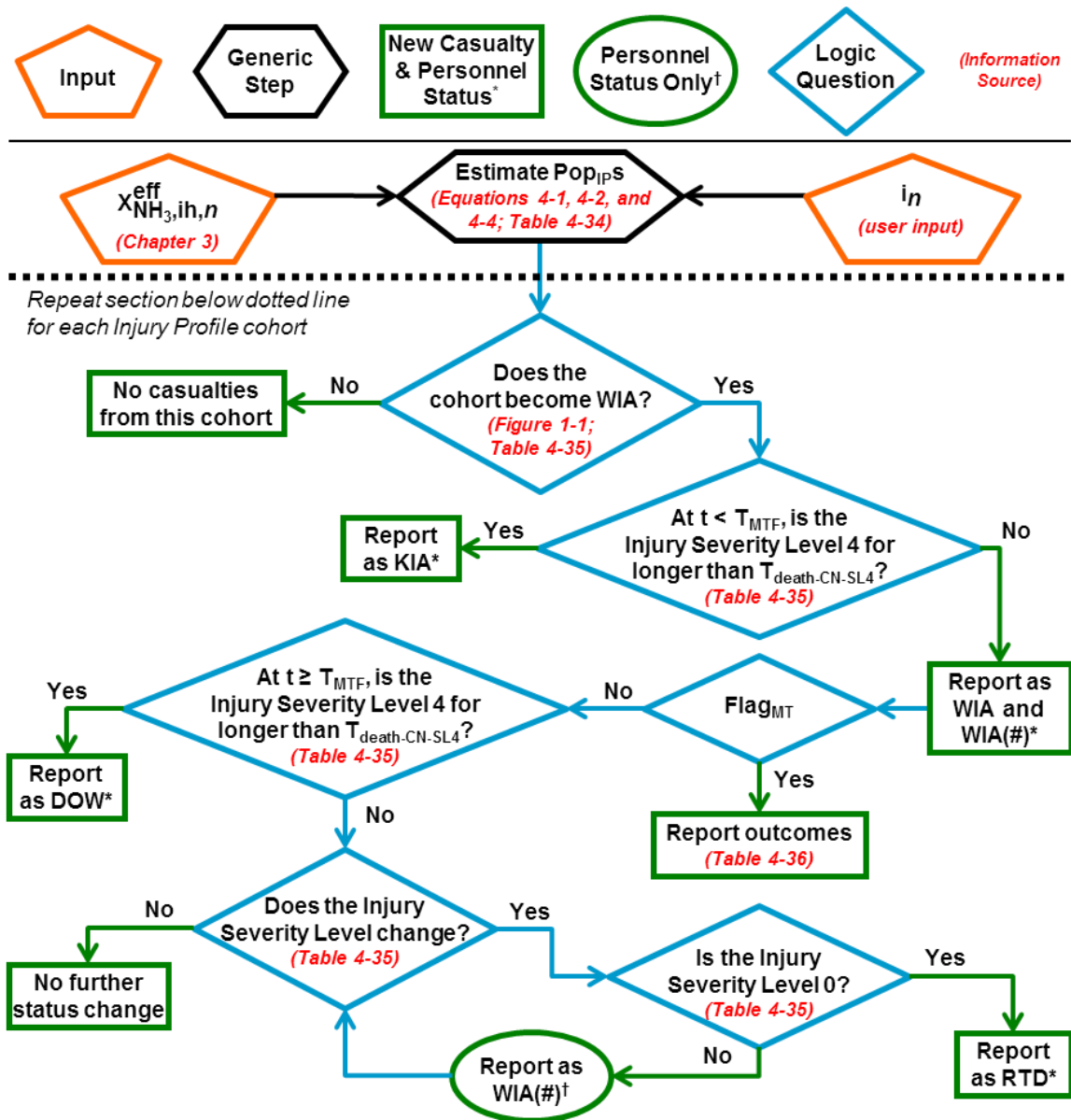

\* Casualty information ( $Pop_{IP}$ ,  $CAT$ ,  $f_{new-CAT}$ ,  $f_{ex-CAT}$ , and  $d$ ) is passed to Equations 4-17 and 4-19.

† Personnel status information ( $Pop_{IP}$ ,  $CAT$ ,  $f_{new-CAT}$ ,  $f_{ex-CAT}$ , and  $d$ ) is passed to Equation 4-19.

**Figure 4-11: Human Response and Casualty Estimation Flowchart for NH<sub>3</sub>**

#### 4.2.11. AC

1. Figure 4-12 summarizes the human response and casualty estimation processes for AC.
2. Assumption. Percutaneous exposure to AC vapour and liquid are negligible.
3. Inhalation is the only AC challenge type considered. Each icon's inhaled Ct ( $X_{AC,ih,n}^{eff}$ ) is estimated according to Chapter 3.
4. Special consideration for AC. Even when  $Flag_{MT} = \text{Yes}$ , medical treatment will not have any effect unless the user sets  $T_{MTF} \leq T_{death-CN-SL4}$ . If this is done, the user may then also choose between whether that treatment involves supportive care alone, or supportive care plus antidote treatment. This choice is captured in the parameter  $MT_{AC}$ , which can have the values "SC" (supportive care) or "AT" (antidote treatment). The default value is AT. Using SC may be warranted in MASCAL scenarios where it is anticipated that insufficient resources will be available.
5. For inhaled AC, Table 4-37 summarizes the toxicity parameters and associated symptoms, Table 4-38 fully describes the associated Injury Profiles, and Table 4-39 describes the outcomes associated with medical treatment.

**Table 4-37: Inhaled AC Toxicity Parameters and Symptoms**

Injury Profile Label	EC <sub>50</sub> [mg-min/m <sup>3</sup> ]	Probit Slope [probits/log(dose)]	TLE	Associated Symptoms
Mild	700	12.0	2.0	Nausea; fatigue and weakness; transient rapid breathing followed by slower breathing; shortness of breath; excitement; anxiety; dizziness; headache
Moderate	1100	12.0	2.0	Episodes of vomiting; increased fatigue and weakness; muscle spasms; difficult to breathe; drowsiness
Severe	1400	12.0	2.0	Severe generalized twitching with or without convulsions; breathing sporadically stops and starts; unconsciousness
Very Severe	2600	12.0	2.0	Convulsions; breathing stops completely; coma



**Table 4-38: Inhaled AC Injury Profiles**

Time Point [min]	Injury Profile			
	Mild	Moderate	Severe	Very Severe
1	1	2	3	4
10	1	1	2	4
15	1	1	2	4*
120	0	1	1	
180	0	0	1	
480	0	0	0	

\* According to the default value for  $T_{\text{death-CN-SL4}}$ , death would be modeled at this point.

**Table 4-39: AC Medical Treatment Outcome Reporting**

Injury Profile	DOW*	CONV*	RTD*
Mild	0%	0%	Day 2: 100%
Moderate	0%	0%	Day 2: 100%
Severe	0%	0%	Day 2: 100%
If $T_{\text{MTF}} \leq T_{\text{death-CN-SL4}}$ and $MT_{\text{AC}} = \text{SC}$			
Very Severe, $X_{\text{AC,ih}}^{\text{eff}} < 5,200$	0%	0%	Day 6: 100%†
Very Severe, $X_{\text{AC,ih}}^{\text{eff}} \geq 5,200$	Day 2: 100%	0%	0%
If $T_{\text{MTF}} \leq T_{\text{death-CN-SL4}}$ and $MT_{\text{AC}} = \text{AT}$			
Very Severe, $X_{\text{AC,ih}}^{\text{eff}} < 26,000$	0%	0%	Day 4: 100%†
Very Severe, $X_{\text{AC,ih}}^{\text{eff}} \geq 26,000$	Day 2: 100%	0%	0%

Note: If  $T_{\text{MTF}} > T_{\text{death-CN-SL4}}$  (as is the default—see Table 2-14), the Very Severe cohort is KIA, so this table is not needed to estimate their outcome.

\* Reported values indicate the fraction that changes status on a given day; they are not cumulative.

† In the personnel status table, these individuals are reported as WIA(3) on Day 2 and remain there until becoming RTD.

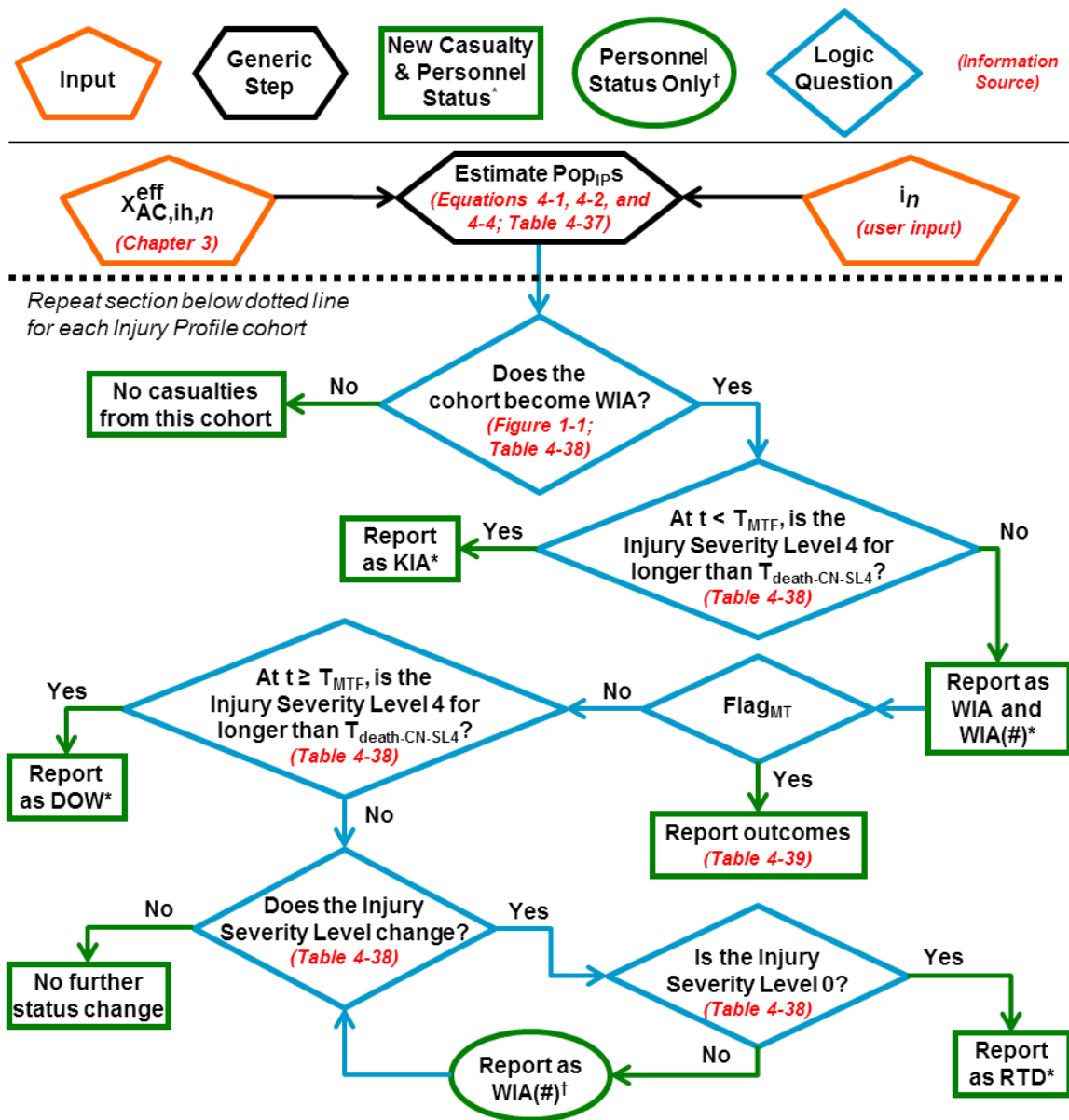

\* Casualty information ( $Pop_{IP}$ ,  $CAT$ ,  $f_{new-CAT}$ ,  $f_{ex-CAT}$ , and  $d$ ) is passed to Equations 4-17 and 4-19.

† Personnel status information ( $Pop_{IP}$ ,  $CAT$ ,  $f_{new-CAT}$ ,  $f_{ex-CAT}$ , and  $d$ ) is passed to Equation 4-19.

Figure 4-12: Human Response and Casualty Estimation Flowchart for AC

#### 4.2.12. CK

- Figure 4-13 summarizes the human response and casualty estimation processes for CK.
- Assumption. Percutaneous exposure to CK vapour and liquid are negligible.
- Inhalation is the only CK challenge type considered. Each icon's inhaled Ct ( $X_{CK,ih,n}^{eff}$ ) and peak concentration ( $X_{CK,[ih],n}^{eff}$ ) are estimated according to Chapter 3.
- Special consideration for CK. Even when  $Flag_{MT} = \text{Yes}$ , medical treatment will not have any effect unless the user sets  $T_{MTF} \leq T_{death-CN-SL4}$ . If this is done, the user may then also choose between whether that treatment involves supportive care alone, or supportive care plus antidote treatment. This choice is captured in the parameter  $MT_{CK}$ , which can have the values "SC" (supportive care) or "AT" (antidote treatment). The default value is AT. Using SC may be warranted in MASCAL scenarios where it is anticipated that insufficient resources will be available.
- For inhaled CK Ct-based effects, Table 4-40 summarizes the toxicity parameters and associated symptoms and Table 4-41 fully describes the associated Injury Profiles. Likewise, Table 4-42 and Table 4-43 describe the symptoms and Injury Profiles for inhaled CK concentration-based effects. Finally, Table 4-44 describes the outcomes associated with medical treatment.

**Table 4-40: Inhaled CK Toxicity Parameters and Symptoms**

Injury Profile Label	$ECt_{50}$ [mg-min/m <sup>3</sup> ]	Probit Slope [probits/log(dose)]	TLE	Associated Symptoms
Mild	1200	12.0	1.45	Nausea; fatigue and weakness; transient rapid breathing followed by slower breathing; shortness of breath; excitement; anxiety; dizziness; headache
Moderate	2100	12.0	1.45	Episodes of vomiting; increased fatigue and weakness; muscle spasms; difficult to breathe; drowsiness
Severe	2800	12.0	1.45	Severe generalized twitching with or without convulsions; breathing sporadically stops and starts; unconsciousness
Very Severe	4700	12.0	1.45	Convulsions; breathing stops completely; coma

**Table 4-41: Inhaled CK Injury Profiles**

Time Point [min]	Injury Profile			
	Mild	Moderate	Severe	Very Severe
1	1	2	3	4
10	1	1	2	4
15	1	1	2	4*
120	0	1	1	
180	0	0	1	
480	0	0	0	

\* According to the default value for  $T_{\text{death-CN-SL4}}$ , death would be modeled at this point.

**Table 4-42: Peak CK Concentration Ranges**

Peak Concentration Range [mg/m <sup>3</sup> ]	Description
< 1	No observable injury
1 – < 20	Ocular and upper respiratory irritation
≥ 20	Severe, but not intolerable, ocular and upper respiratory irritation

**Table 4-43: Peak CK Concentration Injury Profiles**

Time Point [min]	Peak Concentration Range	
	1 – < 20 mg/m <sup>3</sup>	≥ 20 mg/m <sup>3</sup>
1	1	2
2	0	1
10	0	0

**Table 4-44: CK Medical Treatment Outcome Reporting**

Injury Profile	DOW*	CONV*	RTD*
1 – < 20 mg/m <sup>3</sup>	0%	0%	Day 2: 100%
≥ 20 mg/m <sup>3</sup>	0%	0%	Day 2: 100%
Mild	0%	0%	Day 2: 100%
Moderate	0%	0%	Day 2: 100%
Severe	0%	0%	Day 2: 100%
If $T_{\text{MTF}} \leq T_{\text{death-CN-SL4}}$ and $MT_{\text{CK}} = \text{SC}$			
Very Severe, $X_{\text{CK,ih}}^{\text{eff}} < 9,400$	0%	0%	Day 6: 100%†
Very Severe, $X_{\text{CK,ih}}^{\text{eff}} \geq 9,400$	Day 2: 100%	0%	0%
If $T_{\text{MTF}} \leq T_{\text{death-CN-SL4}}$ and $MT_{\text{CK}} = \text{AT}$			
Very Severe, $X_{\text{CK,ih}}^{\text{eff}} < 47,000$	0%	0%	Day 4: 100%†
Very Severe, $X_{\text{CK,ih}}^{\text{eff}} \geq 47,000$	Day 2: 100%	0%	0%

Note: If  $T_{\text{MTF}} > T_{\text{death-CN-SL4}}$  (as is the default—see Table 2-14), the Very Severe cohort is KIA, so this table is not needed to estimate their outcome.

\* Reported values indicate the fraction that changes status on a given day; they are not cumulative.

† In the personnel status table, these individuals are reported as WIA(3) on Day 2 and remain there until becoming RTD.

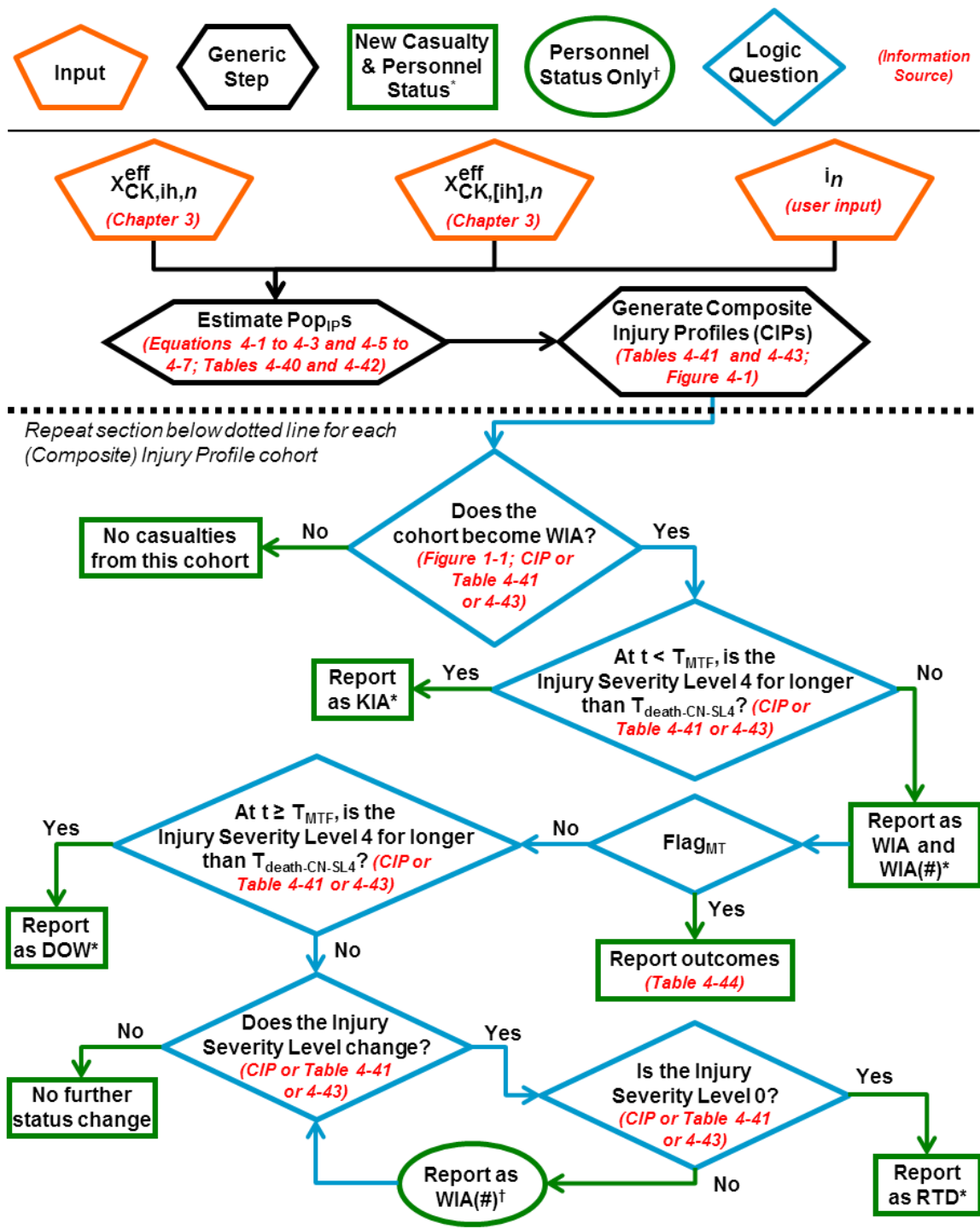

\* Casualty information (Pop<sub>IP</sub>, CAT,  $f_{new-CAT}$ ,  $f_{ex-CAT}$ , and d) is passed to Equations 4-17 and 4-19.  
 † Personnel status information (Pop<sub>IP</sub>, CAT,  $f_{new-CAT}$ ,  $f_{ex-CAT}$ , and d) is passed to Equation 4-19.

Figure 4-13: Human Response and Casualty Estimation Flowchart for CK

4.2.13. H2S

1. Figure 4-14 summarizes the human response and casualty estimation

processes for H<sub>2</sub>S.

2. Assumption. Percutaneous exposure to H<sub>2</sub>S vapour and liquid are negligible.
3. Inhalation is the only H<sub>2</sub>S challenge type considered. Each icon's inhaled Ct ( $X_{H_2S,ih,n}^{eff}$ ) is estimated according to Chapter 3.
4. For inhaled H<sub>2</sub>S, Table 4-45 summarizes the toxicity parameters and associated symptoms, Table 4-46 fully describes the associated Injury Profiles, and Table 4-47 describes the outcomes associated with medical treatment.

**Table 4-45: Inhaled H<sub>2</sub>S Toxicity Parameters and Symptoms**

Injury Profile Label	EC <sub>50</sub> [mg-min/m <sup>3</sup> ]	Probit Slope [probits/log(dose)]	TLE	Associated Symptoms
Mild	400	18.0	5.7	Nausea; fatigue and weakness; transient rapid breathing followed by slower breathing; shortness of breath; excitement; anxiety; dizziness; headache; gritty feeling in eyes; lacrimation; respiratory irritation; olfactory paralysis; cough
Moderate	1500	18.0	5.7	Episodes of vomiting; increased fatigue and weakness; muscle spasms; difficult to breathe; drowsiness; severe eye irritation; blurry vision; sensitivity to light; stronger respiratory irritation
Severe	2200	18.0	5.7	Severe generalized twitching with or without convulsions; breathing sporadically stops and starts; unconsciousness
Very Severe	3200	18.0	5.7	Convulsions; breathing stops completely; coma

**Table 4-46: Inhaled H<sub>2</sub>S Injury Profiles**

Time Point [min]	Injury Profile			
	Mild	Moderate	Severe	Very Severe
1	1	2	3	4
10	1	1	2	4
15	1	1	2	4*
60	0	1	2	
120	0	0	2	
300	0	0	1	
2880	0	0	0	

\* According to the default value for T<sub>death-CN-SL4</sub>, death would be modeled at this point.

**Table 4-47: H<sub>2</sub>S Medical Treatment Outcome Reporting**

Injury Profile	DOW*	CONV*	RTD*
Mild	0%	0%	Day 2: 100%
Moderate	0%	0%	Day 2: 100%
Severe	0%	0%	Day 3: 100%

Injury Profile	DOW*	CONV*	RTD*
If $T_{MTF} \leq T_{death-CN-SL4}$			
Very Severe, $X_{H_2S,ih}^{eff} < 6,400$	0%	0%	Day 21: 100%†
Very Severe, $X_{H_2S,ih}^{eff} \geq 6,400$	Day 21: 100%	0%	0%

Note: If  $T_{MTF} > T_{death-CN-SL4}$  (as is the default—see Table 2-14), the Very Severe cohort is KIA, so this table is not needed to estimate their outcome.

- \* Reported values indicate the fraction that changes status on a given day; they are not cumulative.
- † In the personnel status table, these individuals are reported as WIA(3) on Day 2 and remain there until becoming RTD.

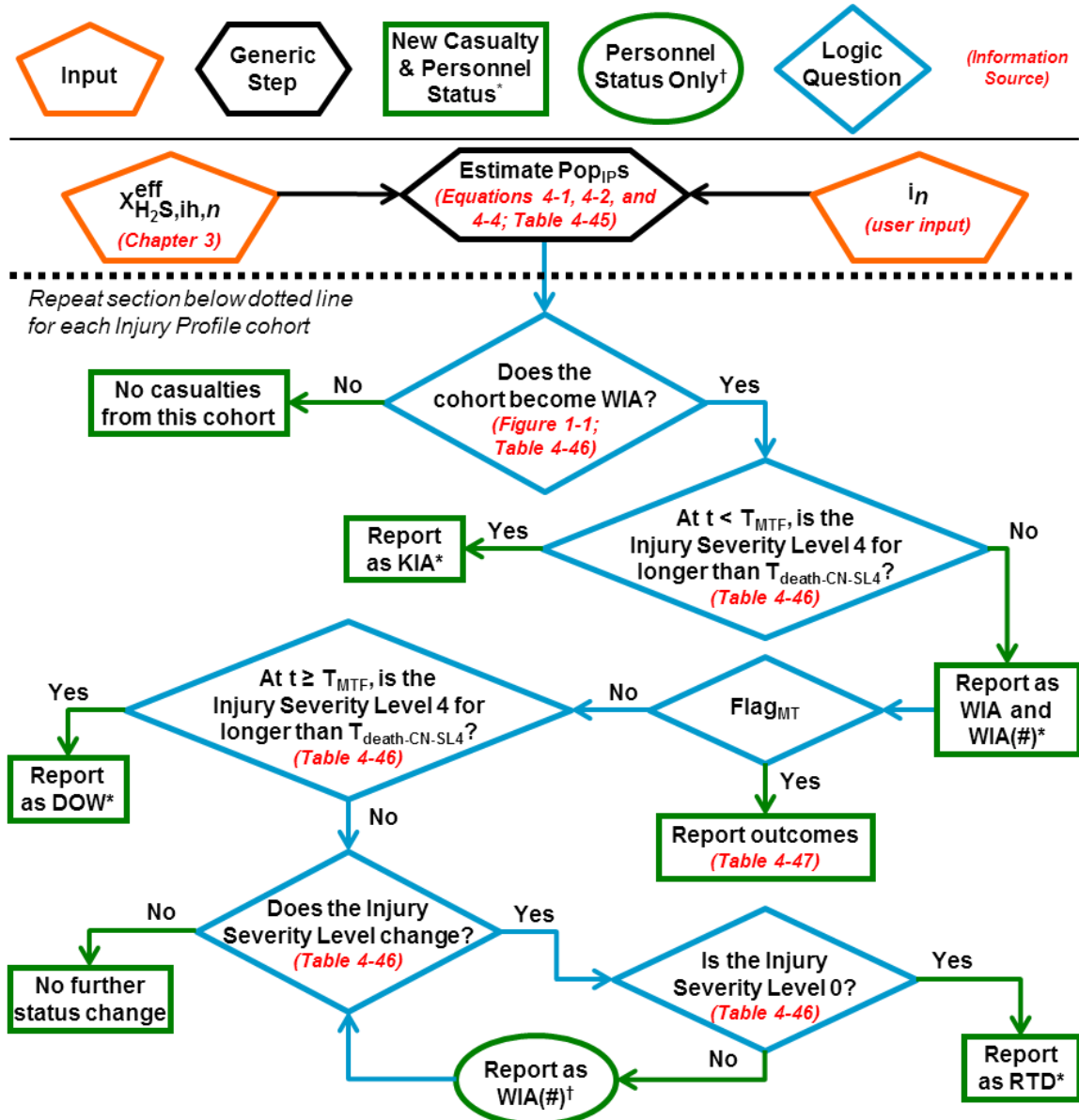

\* Casualty information ( $Pop_{IP}$ ,  $CAT$ ,  $f_{new-CAT}$ ,  $f_{ex-CAT}$ , and  $d$ ) is passed to Equations 4-17 and 4-19.

† Personnel status information ( $Pop_{IP}$ ,  $CAT$ ,  $f_{new-CAT}$ ,  $f_{ex-CAT}$ , and  $d$ ) is passed to Equation 4-19.

Figure 4-14: Human Response and Casualty Estimation Flowchart for H<sub>2</sub>S

### 4.3. RADIOLOGICAL AGENT MODELS

This section begins with a discussion of assumptions and limitations that apply only to radiological agents. Next are separate sections for RDDs and fallout that describe special methods for estimating Effective CBRN Challenge and provide a flowchart summarizing the process from Effective CBRN Challenge to casualty estimate. Following the RDD and fallout sections are two additional sections used for both RDDs and fallout:

- a. Dose ranges, Injury Profiles, and medical treatment outcome reporting tables.
- b. Special considerations for casualty estimation.

#### 4.3.1. Assumptions and Limitation

1. Assumptions
  - a. Individuals will decontaminate the skin after exiting the radiation area.
  - b. Human response is independent of the source of exposure. For example, whole-body radiation Injury Profiles for radiological incidents are identical to those used for whole-body radiation under the nuclear effects models.
  - c. Human response due to whole-body radiation dose and cutaneous radiation dose are independent of one another—the effects of each challenge type are modeled separately, and are only combined via a Composite Injury Profile.
  - d. For the purpose of estimating time to death due to whole-body radiation, each icon's dose rate is equal to the icon's total whole-body dose divided by the time during which the dose accumulated.
2. Limitation. Dose protraction—a sufficiently low dose rate such that some physiological recovery occurs simultaneously with the challenge—is only included as it pertains to determining whether a casualty will die; the Injury Profiles do not account for dose protraction.

#### 4.3.2. RDDs

1. Figure 4-15 summarizes the human response and casualty estimation processes for RDDs.
2. Assumptions, limitations, and constraint.
  - a. Assumptions.
    - 1) The activity deposited on the ground at the icon's location is equal to the activity deposited on the skin of each individual in the icon.
    - 2) For calculations of dose due to groundshine, the activity concentration at



the icon's location for the time period of interest is uniformly extended to infinity in all directions.

- 3) For the purpose of deriving the dose conversion factors in Table 3-1, absorbed dose (in units of gray) is equal to dose equivalent (in units of sievert).
- 4) Cutaneous dose due to beta emitters contaminating *the clothing* is negligible<sup>64</sup> (contamination of the *skin* is counted).
- 5) The dose from inhalation of radiological particles is equal to the 30-day committed effective dose equivalent and is combined with the cloudshine and groundshine doses to determine an overall whole-body dose.

b. Limitations.

- 1) Conventional casualties (i.e., from high explosives and fragmentation) that might occur as part of a RDD incident are ignored.
- 2) Gamma radiation due to skin contamination is ignored because it is typically only a few percent of the beta radiation dose.<sup>65</sup>

c. Constraint. Because the user is forced to choose either a gamma radiation protection factor *or* a beta radiation protection factor for each isotope, that protection factor is applied to all radiation emitted by that isotope.

3. Whole-body radiation (from cloudshine, groundshine, and inhalation) and cutaneous radiation (from cloudshine, groundshine, and skin contamination) are the challenge types considered for RDDs.

a. Whole-body radiation.

- 1) Note that the cloudshine and groundshine components of whole-body radiation from RDDs can be a mix of different types of radiation. In calculating the APF, appropriate protection factors (from Table 2-7 or national sources) must be chosen for each isotope, based on the type of radiation it *primarily* emits—see the footnote on Table 3-1.
- 2) Each icon's isotope-specific absorbed whole-body dose from cloudshine from an RDD ( $X_{\text{RDD,wb,cl,d,r,n}}^{\text{eff}}$ ) is estimated according to Chapter 3. Then, the isotope-specific doses are summed to determine the total absorbed whole-

---

<sup>64</sup> T. J. Cerveny, T. J. MacVittie, and R. W. Young, "Acute Radiation Syndrome in Humans," in *Warfare, Weaponry, and the Casualty*, ed. Richard I. Walker and T. J. Cerveny, *Textbooks of Military Medicine* (Falls Church, VA: Office of the Surgeon General, Department of the Army, 1996), 15–36, 21.

<sup>65</sup> IAEA, *Generic Procedures for a Radiological Emergency*, 104.

body dose from cloudshine from an RDD ( $X_{RDD,wb,cl,d,n}^{eff}$ ), according to Equation 4-23.

$$X_{RDD,wb,cl,d,n}^{eff} = \sum_r X_{RDD,wb,cl,d,r,n}^{eff} \quad (4-23)$$

where:

$X_{RDD,wb,cl,d,n}^{eff}$  is the absorbed whole-body cloudshine dose from an RDD for icon  $n$  [Gy], and

$X_{RDD,wb,cl,d,r,n}^{eff}$  is the absorbed whole-body cloudshine dose from the  $r^{th}$  radioisotope from an RDD for icon  $n$  [Gy] (derived according to Chapter 3, from the output of the user's national hazard prediction model).

- 3) Each icon's isotope-specific absorbed whole-body dose from groundshine from an RDD ( $X_{RDD,wb,grd,r,n}^{eff}$ ) is estimated according to Chapter 3. Then, the isotope-specific doses are summed to determine the total absorbed whole-body dose from groundshine from an RDD ( $X_{RDD,wb,grd,n}^{eff}$ ), according to Equation 4-24.

$$X_{RDD,wb,grd,n}^{eff} = \sum_r X_{RDD,wb,grd,r,n}^{eff} \quad (4-24)$$

where:

$X_{RDD,wb,grd,n}^{eff}$  is the absorbed whole-body groundshine dose from an RDD for icon  $n$  [Gy], and

$X_{RDD,wb,grd,r,n}^{eff}$  is the absorbed whole-body groundshine dose from the  $r^{th}$  radioisotope from an RDD for icon  $n$  [Gy] (derived according to Chapter 3, from the output of the user's national hazard prediction model).

- 4) Each icon's isotope-specific absorbed whole-body dose from inhalation of radiological particles from an RDD ( $X_{RDD,wb,ih,r,n}^{eff}$ ) is estimated according to Chapter 3. Then, the isotope-specific doses are summed to determine the total absorbed whole-body dose from inhalation of radiological particles from an RDD ( $X_{RDD,wb,ih,n}^{eff}$ ), according to Equation 4-26.

$$X_{RDD,wb,ih,n}^{eff} = \sum_r X_{RDD,wb,ih,r,n}^{eff} \quad (4-25)$$

where:

$X_{RDD,wb,ih,n}^{eff}$  is the absorbed whole-body dose from inhalation of radiological particles from an RDD for icon  $n$  [Gy], and

$X_{\text{RDD,wb,ih},r,n}^{\text{eff}}$  is the absorbed whole-body dose from inhalation of radiological particles of the  $r^{\text{th}}$  radioisotope from an RDD for icon  $n$  [Gy] (derived according to Chapter 3, from the output of the user's national hazard prediction model).

- 5) Finally, each icon's total absorbed whole-body dose from an RDD ( $X_{\text{RDD,wb},n}^{\text{eff}}$ ) is calculated according to Equation 4-26.

$$X_{\text{RDD,wb},n}^{\text{eff}} = X_{\text{RDD,wb,cld},n}^{\text{eff}} + X_{\text{RDD,wb,grd},n}^{\text{eff}} + X_{\text{RDD,wb,ih},n}^{\text{eff}}, \quad (4-26)$$

where:

$X_{\text{RDD,wb},n}^{\text{eff}}$  is the total absorbed whole-body dose from an RDD for icon  $n$  [Gy], and

the other terms are as previously defined.

b. Cutaneous radiation.

- 1) Note that the cloudshine and groundshine components of cutaneous radiation from RDDs can be a mix of different types of radiation. In calculating the APF, appropriate protection factors (from Table 2-7) must be chosen for each isotope, based on the type of radiation it *primarily* emits—see the footnote on Table 3-1. On the contrary, the skin contamination component is entirely from beta radiation.
- 2) Each icon's isotope-specific absorbed cutaneous dose from cloudshine from an RDD ( $X_{\text{RDD,cut,cld},r,n}^{\text{eff}}$ ) is estimated according to Chapter 3. Then, the isotope-specific doses are summed to determine the total absorbed cutaneous dose from cloudshine from an RDD ( $X_{\text{RDD,cut,cld},n}^{\text{eff}}$ ), according to Equation 4-27.

$$X_{\text{RDD,cut,cld},n}^{\text{eff}} = \sum_r X_{\text{RDD,cut,cld},r,n}^{\text{eff}}, \quad (4-27)$$

where:

$X_{\text{RDD,cut,cld},n}^{\text{eff}}$  is the absorbed cutaneous cloudshine dose from an RDD for icon  $n$  [Gy], and

$X_{\text{RDD,cut,cld},r,n}^{\text{eff}}$  is the absorbed cutaneous cloudshine dose from the  $r^{\text{th}}$  radioisotope from an RDD for icon  $n$  [Gy] (derived according to Chapter 3, from the output of the user's national hazard prediction model).

- 3) Each icon's isotope-specific absorbed cutaneous dose from groundshine from an RDD ( $X_{\text{RDD,cut,grd},r,n}^{\text{eff}}$ ) is estimated according to Chapter 3. Then, the isotope-specific doses are summed to determine the total absorbed

cutaneous dose from groundshine from an RDD ( $X_{RDD,cut,grd,n}^{eff}$ ) according to Equation 4-28.

$$X_{RDD,wb,grd,n}^{eff} = \sum_r X_{RDD,cut,grd,r,n}^{eff} \quad (4-28)$$

where:

$X_{RDD,cut,grd,n}^{eff}$  is the absorbed cutaneous groundshine dose from an RDD for icon  $n$  [Gy], and

$X_{RDD,cut,grd,r,n}^{eff}$  is the absorbed cutaneous groundshine dose from the  $r^{th}$  radioisotope from an RDD for icon  $n$  [Gy] (derived according to Chapter 3, from the output of the user's national hazard prediction model).

- 4) Each icon's isotope-specific absorbed cutaneous dose from skin contamination from an RDD ( $X_{RDD,cut,s,r,n}^{eff}$ ) is estimated according to Chapter 3, but with hazard prediction model output for groundshine as the data source for the challenge. Then, the isotope-specific doses are summed to determine the total absorbed cutaneous dose from skin contamination from an RDD ( $X_{RDD,cut,s,n}^{eff}$ ) according to Equation 4-29.

$$X_{RDD,cut,s,n}^{eff} = \sum_r X_{RDD,cut,s,r,n}^{eff} \quad (4-29)$$

where:

$X_{RDD,cut,s,n}^{eff}$  is the absorbed cutaneous dose from skin contamination from an RDD for icon  $n$  [Gy], and

$X_{RDD,cut,s,r,n}^{eff}$  is the absorbed cutaneous dose from skin contamination from the  $r^{th}$  radioisotope from an RDD for icon  $n$  [Gy] (derived according to Chapter 3, from the output of the user's national hazard prediction model).

- 5) Finally, each icon's total cutaneous dose from an RDD ( $X_{RDD,cut,n}^{eff}$ ) is estimated according to Equation 4-30.

$$X_{RDD,cut,n}^{eff} = X_{RDD,cut,cld,n}^{eff} + X_{RDD,cut,grd,n}^{eff} + X_{RDD,cut,s,n}^{eff} \quad (4-30)$$

where:

$X_{RDD,cut,n}^{eff}$  is the total cutaneous dose for from an RDD icon  $n$  [Gy], and the other terms are as previously defined.

4. For each whole-body radiation dose range, Table 4-52 summarizes the associated symptoms, Table 4-53 fully describes the associated Injury Profile for

untreated personnel, and Table 4-54 describes the outcomes associated with medical treatment. Likewise for cutaneous radiation, Table 4-49 summarizes the associated symptoms, Table 4-50 fully describes the associated Injury Profile for untreated personnel, and Table 4-51 describes the outcomes associated with medical treatment.



\* Casualty information ( $i_n$ , CAT,  $f_{new-CAT}$ ,  $f_{ex-CAT}$ , and  $d$ ) is passed to Equations 4-18 and 4-20.  
 † Personnel status information ( $i_n$ , CAT,  $f_{new-CAT}$ ,  $f_{ex-CAT}$ , and  $d$ ) is passed to Equation 4-20.

Figure 4-15: Human Response and Casualty Estimation Flowchart for RDDs

### 4.3.3. Fallout

1. Figure 4-16 summarizes the human response and casualty estimation processes for RDDs.
2. Assumptions, limitations, and constraint.
  - a. Assumptions.
    - 1) Icons enter the radiation area only after all fallout has deposited on the ground.
    - 2) The deposition concentration on the skin is equal to the ground concentration at the icon's location.
  - b. Limitations.
    - 1) Gamma radiation due to skin contamination is ignored because it is typically only a few percent of the beta radiation dose.<sup>66</sup>
    - 2) Isotope-specific dose calculations are not performed for fallout because most hazard-prediction models do not specify the distribution of radioisotopes in fallout.
  - c. Constraint. Only radiation from groundshine and skin contamination are considered.
3. Whole-body radiation (from gamma radiation due to groundshine) and cutaneous radiation (from beta and gamma radiation due to groundshine and beta radiation from skin contamination) are the challenge types considered for fallout. A key difference for fallout, relative to RDDs, is that most hazard prediction models do not specify the distribution of radioisotopes in fallout. Thus, the equations below are not isotope-specific. Note: the equations do not account for the fallout decay rate<sup>67</sup> because it is assumed the user's national hazard prediction model will do so.
  - a. Whole-body radiation. Each icon's absorbed whole-body dose from fallout ( $X_{FO,wb,n}^{eff}$ ) is estimated according to Chapter 3, based solely on input for gamma radiation due to groundshine from fallout (derived from the user's national hazard prediction model).
  - b. Cutaneous radiation.

<sup>66</sup> IAEA, *Generic Procedures for a Radiological Emergency*, 104.

<sup>67</sup> On average, the fallout dose rate decays as  $t^{-1.2}$ . See U.S. Department of the Army, *The Effects of Nuclear Weapons*, Army Pamphlet 50-3 (Washington, DC: U.S. Department of the Army, March 1977), 451 and Figure 19.6b.

- 1) Each icon's absorbed cutaneous dose from gamma radiation due to groundshine from fallout ( $X_{FO,cut,grd-\gamma,n}^{eff}$ ) is equal to its absorbed whole-body dose ( $X_{FO,wb,n}^{eff}$ ).
- 2) Each icon's absorbed cutaneous dose from beta radiation due to groundshine from fallout ( $X_{FO,cut,grd-\beta,n}^{eff}$ ) is estimated based on the gamma dose due to groundshine from fallout by means of a "gamma to beta" dose ratio. Thus, the Chapter 3 equations are fed input values for *gamma* groundshine from fallout (the same input used to calculate  $X_{FO,wb,n}^{eff}$ ), but the APF should be based on *beta* radiation protection factors (see Table 2-4 and paragraph 2.1.6.2.d).
- 3) Each icon's absorbed cutaneous dose from beta radiation due to skin contamination from resuspension of fallout ( $X_{FO,cut,s,n}^{eff}$ ) is estimated according to Chapter 3.
- 4) Finally, each icon's total cutaneous dose from fallout ( $X_{FO,cut,n}^{eff}$ ) is estimated according to Equation 4-31.

$$X_{FO,cut,n}^{eff} = X_{FO,cut,grd-\gamma,n}^{eff} + X_{FO,cut,grd-\beta,n}^{eff} + X_{FO,cut,s,n}^{eff}, \quad (4-31)$$

where:

$X_{FO,cut,n}^{eff}$  is the total cutaneous dose from fallout for icon  $n$  [Gy], and  
the other terms are as previously defined.

4. For each whole-body radiation dose range, Table 4-52 summarizes the associated symptoms, Table 4-53 fully describes the associated Injury Profile for untreated personnel, and Table 4-54 describes the outcomes associated with medical treatment. Likewise for cutaneous radiation, Table 4-49 summarizes the associated symptoms, Table 4-50 fully describes the associated Injury Profile for untreated personnel, and Table 4-51 describes the outcomes associated with medical treatment.



\* Casualty information ( $i_n$ , CAT,  $f_{new-CAT}$ ,  $f_{ex-CAT}$ , and d) is passed to Equations 4-18 and 4-20.

† Personnel status information ( $i_n$ , CAT,  $f_{new-CAT}$ ,  $f_{ex-CAT}$ , and d) is passed to Equation 4-20.

Figure 4-16: Human Response and Casualty Estimation Flowchart for Fallout



#### 4.3.4. Threshold Lethal Dose and Time to Death

1. If an icon's total absorbed whole-body dose from an RDD or fallout ( $X_{\text{RDD/FO,wb},n}^{\text{eff}}$ ) is above a certain threshold dose, labeled  $D_{\text{death,wb},n}$ , the individuals in that icon are estimated to die (time of death is discussed below). The threshold dose depends upon the dose rate, as described in Equation 4-32 (an empirical equation).<sup>68</sup>

$$D_{\text{death,wb},n} = \frac{LD_{50,MT}}{-0.2351 \cdot 0.8946 \left( \frac{X_{\text{RDD/FO,wb},n}^{\text{eff}}}{\text{Dur}_n} \right) \cdot \left( \frac{X_{\text{RDD/FO,wb},n}^{\text{eff}}}{\text{Dur}_n} \right)^{-0.2876} + 0.9947}, \quad (4-32)$$

where:

$D_{\text{death,wb},n}$  is the threshold dose above which individuals in icon  $n$  are estimated to die [Gy],

$LD_{50,MT}$  is the  $LD_{50}$  for an instantaneous challenge [gray], which is a function of whether medical treatment is provided, and if so, whether granulocyte colony-stimulating factor (G-CSF) is part of that treatment (see Table 4-48),

$X_{\text{RDD/FO,wb},n}^{\text{eff}}$  is the total absorbed whole-body dose from an RDD or from fallout for icon  $n$  [Gy], and

$\text{Dur}_n$  is the duration of exposure for Icon  $n$  [hr] (derived from the user's national hazard prediction model).

**Table 4-48: Whole-Body Radiation  $LD_{50}$  for Instantaneous Challenges**

Situation	$LD_{50}$ [Gy]
No medical treatment	4.5
Medical treatment excluding G-CSF	6.8
Medical treatment including G-CSF	8.5

2. For icons with total absorbed whole-body dose above  $D_{\text{death,wb},n}$ , the time to death is estimated by an empirical equation, Equation 4-33.<sup>69</sup>

$$T_{\text{death,wb},n} = 429 \cdot \left( X_{\text{RDD/FO,wb},n}^{\text{eff}} \right)^{-1.3}, \quad (4-33)$$

where:

<sup>68</sup> Derived from data presented in Gene E. McClellan, David J. Crary, and Darren R. Oldson, *Approximating the Probability of Mortality Due to Protracted Radiation Exposures*, DTRA-TR-16-054 (Fort Belvoir, VA: Defense Threat Reduction Agency, June 2016), 11, Table 1. Since Equation 4-32 treats the dose rate as constant, it is best applied in scenarios such as involving long-lived radioisotopes from an RDD or a fallout area more than few hours old.

<sup>69</sup> Derived from data presented in U.S. Department of the Army, *Personnel Risk and Casualty Criteria for Nuclear Weapons Effects*, Army Pamphlet 50-7 (Washington, DC: U.S. Department of the Army, 1 October 2013), 123 (Figure C-21).

$T_{\text{death,wb},n}$  is the time between the end of exposure and death for individuals at icon  $n$  [days],

$X_{\text{RDD/FO,wb},n}^{\text{eff}}$  is the total absorbed whole-body dose from an RDD or from fallout for icon  $n$  [Gy], and

the equation can only be applied for  $X_{\text{RDD/FO,wb},n}^{\text{eff}} \leq 100$  Gy; for  $X_{\text{RDD/FO,wb},n}^{\text{eff}} > 100$  Gy, use  $T_{\text{death,wb},n} = 1$  day.

### 4.3.5. Dose Ranges, Injury Profiles, and Medical Treatment Outcomes

Because the dose ranges, Injury Profiles, and medical treatment outcome reporting tables for radiological challenges and injuries are independent of the challenge source, the tables presented below apply to both RDDs and fallout. Further, the whole-body tables also pertain to initial whole-body radiation challenges from nuclear detonations (described in detail in Section 4.4).

**Table 4-49: Cutaneous Radiation Dose Ranges**

Dose Range [Gy]	Description
< 2	No observable injury
2 – < 15	12 hours to 5 weeks post exposure: erythema, slight edema, possible increased pigmentation; 6 to 7 weeks post exposure: dry desquamation
15 – < 40	Immediate itching; 1 to 3 weeks post exposure: erythema, edema; 5 to 6 weeks post exposure: subcutaneous tissue edema, blisters, moist desquamation; late effects (> 10 weeks)
40 – < 550	Immediate pain, tingling for 1 to 2 days; 1 to 2 weeks post exposure: erythema, blisters, edema, pigmentation, erosions, ulceration, severe pain; severe late effects (> 10 weeks)
≥ 550	Immediate pain, tingling, swelling; 1 to 4 days post exposure: blisters, early ischemia, substantial pain; tissue necrosis within 2 weeks, substantial pain

**Table 4-50: Cutaneous Radiation Injury Profiles**

Time Point [hr]	Dose Range			
	2 – < 15 Gy	15 – < 40 Gy	40 – < 550 Gy	≥ 550 Gy
0.1	0	0	0	1
1	0	0	1	1
8	0	1	1	1
10	1	1	1	1
24	1	1	1	2
48	0	0	2	2
192	0	0	3	3

**Table 4-51: Cutaneous Radiation Medical Treatment Outcome Reporting**

Dose Range [Gy]	DOW*	CONV*	RTD*
2 – < 15	0%	0%	Day 3: 100%
15 – < 40	0%	0%	Day 3: 100%
40 – < 550	0%	Day 3: 100%	0%
≥ 550	0%	Day 3: 100%	0%

\* Reported values indicate the fraction that changes status on a given day; they are not cumulative.

**Table 4-52: Whole-Body Radiation Dose Ranges**

Dose Range [Gy]	Description
< 1.25	No observable injury
1.25 – < 3	A slight decrease in white blood cell and platelet count with possible beginning symptoms of bone marrow damage; survival is > 90% unless there are other injuries
3 – < 4.5	Moderate to severe bone marrow damage occurs; lethality ranges from LD <sub>50/60</sub> to LD <sub>50/60</sub> ; these patients require greater than 30 days recovery, but other injuries would increase the injury severity and likelihood of death
4.5 – < 8.3	Severe bone marrow damage occurs; lethality ranges from LD <sub>50/60</sub> to LD <sub>99/60</sub> ; death occurs within 3.5 to 6 weeks with the radiation injury alone but is accelerated with other injuries; with other injuries death may occur within 2 weeks
≥ 8.3	Bone marrow pancytopenia and moderate intestinal damage occur including diarrhea; death is expected within 2 to 3 weeks; with other injuries death may occur within 2 weeks; at higher doses, combined gastrointestinal and bone marrow damage occur with hypotension and death is expected within 1 to 2.5 weeks or if other injuries are also present, within 6 days

**Table 4-53: Whole-Body Radiation Injury Profiles**

Time Point [hr]	Dose Range			
	1.25 – < 3 Gy	3 – < 4.5 Gy	4.5 – < 8.3 Gy	≥ 8.3 Gy
0.3	0	0	1	3
0.7	0	0	2	3
2	0	2	3	3
3	1	2	3	3
5	1	3	3	3
8	1	2	3	3
24	0	1	2	3
30	0	0	2	3
48	0	0	1	3
72	0	0	0	3
90	0	0	1	3
96	0	0	2	3
192	0	2	3	4
600	0	2	4	4
696	0	3	4	4

**Table 4-54: Whole-Body Radiation Medical Treatment Outcome Reporting**

Dose Range [Gy]	DOW <sup>*</sup>	CONV <sup>*</sup>	RTD <sup>*</sup>
1.25 – < 3	0%	Day 2: 100%	0%
For Treatment Excluding Granulocyte-Colony Stimulating Factor (G-CSF)			
3 – < 6.8	0%	Day 30: 100%	0%
≥ 6.8	Rad: See Equation 4-32 <sup>†</sup> Nuclear: 100% <sup>†</sup>	Rad: Day 30: 100% of WIAs that do not DOW	0%
For Treatment Including G-CSF			
3 – < 8.5	0%	Day 30: 100%	0%
≥ 8.5	Rad: See Equation 4-32 <sup>†</sup> Nuclear: 100% <sup>†</sup>	Rad: Day 30: 100% of WIAs that do not DOW	0%

\* Reported values indicate the fraction that changes status on a given day; they are not cumulative.

† Equations 4-33 and 4-35 estimate time of death for radiological and nuclear DOWs, respectively.

#### 4.4. NUCLEAR EFFECTS MODELS

1. A nuclear detonation may result in four challenges for each icon. Immediately after the detonation, icons may receive whole-body radiation, blast, and thermal challenges; the modeling of these “prompt” challenges is described in this section. Later, icons may receive a fallout challenge; the modeling of this delayed effect was discussed in Section 4.3.

2. This section begins with a discussion of assumptions and limitations that apply only to prompt nuclear effects. Following that are separate sections on each prompt nuclear effect that describe special methods for estimating Effective CBRN Challenge and provide a flowchart summarizing the process from Effective CBRN Challenge to casualty estimate. The final subsection briefly discusses how the methodology accounts for the combined effects of nuclear weapons.

##### 4.4.1. Assumptions and Limitations

1. Assumptions.
  - a. Human response is independent of the source of exposure. For example, whole-body radiation Injury Profiles for radiological incidents are identical to those used for whole body radiation under the nuclear effects models.
  - b. The entire challenge occurs immediately following the detonation (consistent with fallout being modeled separately, as described in Section 4.3.3).
2. Limitation. The combined effects of prompt nuclear injuries are not considered; Composite Injury Profiles are *not* used, and initial radiation, blast, and burn injuries are considered separately.

##### 4.4.2. Initial Whole-Body Radiation

1. Figure 4-17 summarizes the human response and casualty estimation processes for initial whole-body radiation from a nuclear detonation.
2. Assumption. The relative biological effectiveness (RBE) for neutron/gamma radiation is 1.
3. Initial whole-body radiation from a nuclear detonation comprises two components: neutron radiation and gamma radiation.
  - a. Each icon’s absorbed whole-body dose from neutron radiation ( $X_{\text{nuc,wb,n}^0,n}^{\text{eff}}$ ) is estimated according to Chapter 3.
  - b. Each icon’s absorbed whole-body dose from gamma radiation ( $X_{\text{nuc,wb,\gamma,n}}^{\text{eff}}$ ) is estimated according to Chapter 3.
  - c. Finally, each icon’s total absorbed whole-body dose from initial radiation from

a nuclear detonation ( $X_{\text{nuc,wb},n}^{\text{eff}}$ ) is calculated according to Equation 4-34.

$$X_{\text{nuc,wb},n}^{\text{eff}} = X_{\text{nuc,wb},n^0,n}^{\text{eff}} + X_{\text{nuc,wb},\gamma,n}^{\text{eff}}, \quad (4-34)$$

where:

$X_{\text{nuc,wb},n}^{\text{eff}}$  is the total absorbed whole-body dose from initial radiation from a nuclear detonation for icon  $n$  [Gy], and

the other terms are as previously defined.

4. Special considerations for initial whole-body radiation casualty estimation.
  - a. If an icon's total absorbed whole-body dose from prompt nuclear radiation ( $X_{\text{nuc,wb},n}^{\text{eff}}$ ) is greater than 4.5 Gy, the individuals in that icon are estimated to die if no treatment is provided. If treatment is provided, the medical treatment outcome reporting table (Table 4-54) is used.
  - b. Time to death, whether with or without medical treatment, is determined by an empirical equation, Equation 4-35.<sup>70</sup>

$$T_{\text{death,wb},n} = 429 \cdot (X_{\text{nuc,wb},n}^{\text{eff}})^{-1.3}, \quad (4-35)$$

where:

$T_{\text{death,wb},n}$  is the time between the end of exposure and death for individuals at icon  $n$  [days],

$X_{\text{nuc,wb},n}^{\text{eff}}$  is the total absorbed whole-body dose from prompt nuclear radiation for icon  $n$  [Gy], and

the equation can only be applied for  $X_{\text{nuc,wb},n}^{\text{eff}} \leq 100$  Gy; for  $X_{\text{nuc,wb},n}^{\text{eff}} > 100$  Gy, use  $T_{\text{death,wb},n} = 1$  day.

5. For each total absorbed whole-body dose range, the symptoms, Injury Profile, and medical outcomes are the same as those described for whole-body radiation doses from RDDs or fallout. Thus, Table 4-52 summarizes the associated symptoms, Table 4-53 fully describes the associated Injury Profile for untreated personnel, and Table 4-54 describes the outcomes associated with medical treatment.

<sup>70</sup> U.S. Department of the Army, *Personnel Risk and Casualty Criteria*, 123 (Figure C-21).

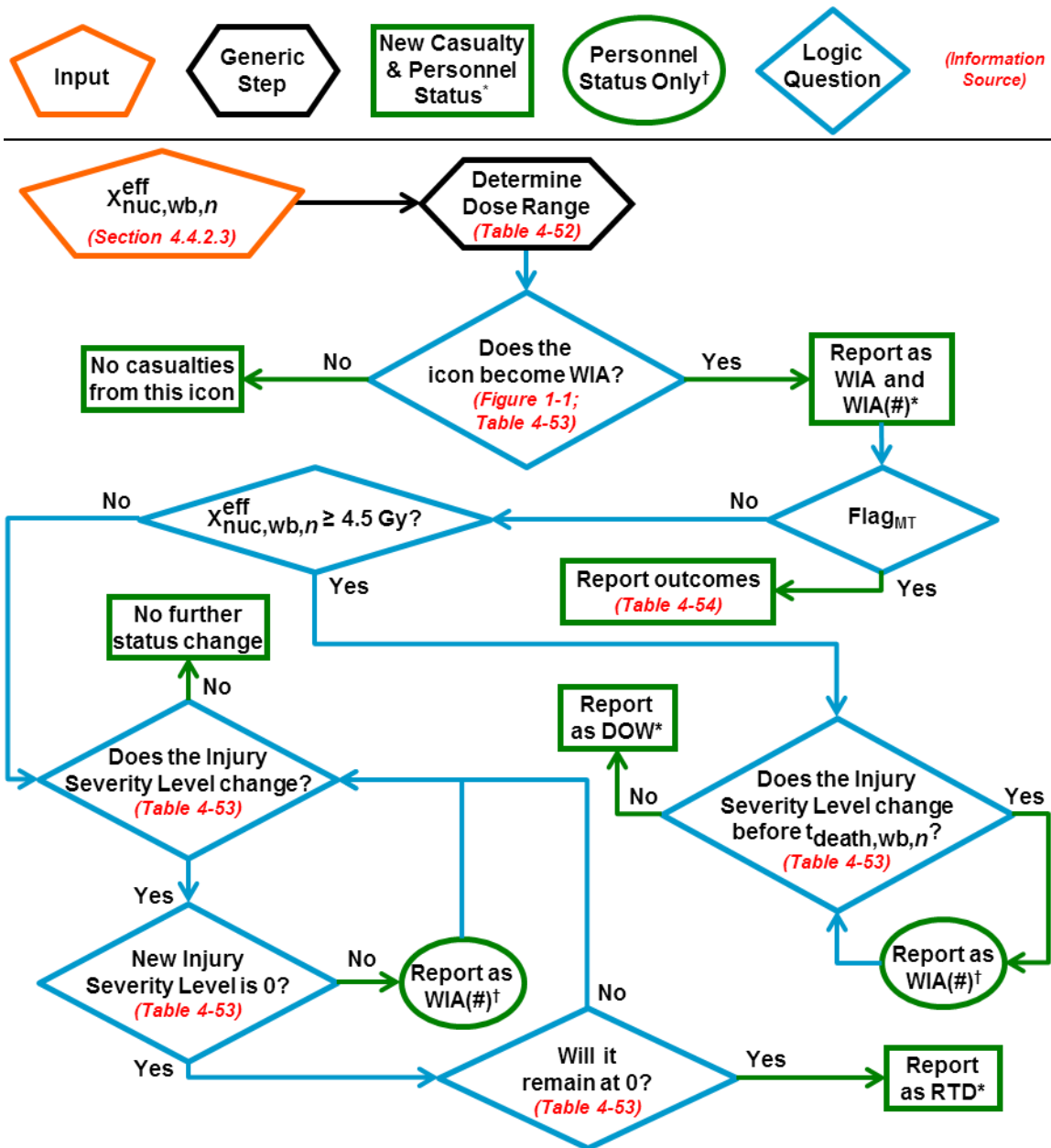

\* Casualty information ( $i_n$ , CAT,  $f_{new-CAT}$ ,  $f_{ex-CAT}$ , and d) is passed to Equations 4-18 and 4-20.

† Personnel status information ( $i_n$ , CAT,  $f_{new-CAT}$ ,  $f_{ex-CAT}$ , and d) is passed to Equation 4-20.

**Figure 4-17: Human Response and Casualty Estimation Flowchart for Initial Whole-Body Radiation From a Nuclear Detonation**

### 4.4.3. Blast

1. Figure 4-18 summarizes the human response and casualty estimation processes for nuclear blast.
2. Limitations and constraints.
  - a. Limitation. Secondary effects (missiling) are not included in any way.
  - b. Constraints.
    - 1) The blast model primarily accounts for primary blast effects (static overpressure, or barotrauma).
    - 2) It also uses the blast static overpressure as an index to partially account for tertiary effects (whole-body translation and decelerative tumbling); additional KIAs are estimated as a function of weapon yield.
3. Each icon's primary nuclear blast insult ( $X_{\text{nuc,blast},n}^{\text{eff}}$ ) is estimated according to Chapter 3.
4. Special consideration for nuclear blast casualty estimation. A threshold blast static overpressure insult ( $I_{\text{death,blast}}$ ), above which icons *not occupying a vehicle or shelter* are estimated to be KIA, is used to account for lethal tertiary effects. Equation 4-36 is used to calculate the specific value of the threshold.<sup>71</sup>

$$I_{\text{death,blast}} = \begin{cases} -170.68 \cdot \ln(W) + 689.47, & \text{for } 1 \text{ kT} \leq \text{yield} \leq 10 \text{ kT} \\ -56.89 \cdot \ln(W) + 427.47, & \text{for } 10 \text{ kT} < \text{yield} \leq 100 \text{ kT} \end{cases} \quad (4-36)$$

where:

$I_{\text{death,blast}}$  is the static blast overpressure insult threshold above which it is estimated that personnel not occupying a vehicle or shelter will be KIA [kPa], and

W is the yield of the weapon [kT].

5. For each primary nuclear blast insult range, Table 4-55 summarizes the associated symptoms, Table 4-56 fully describes the associated Injury Profile for untreated personnel, and Table 4-57 describes the outcomes associated with medical treatment.

---

<sup>71</sup> Equation 4-36 is derived from data presented in M. K. Drake et al., *An Interim Report on Collateral Damage*, DNA 4734Z (La Jolla, CA: Science Applications, Inc., October 1978), 5-94.

**Table 4-55: Primary Nuclear Blast Insult Ranges**

Insult Range [kPa]	Description
< 50	No observable injury
50 – < 140	Eardrum rupture in 50%; threshold lung damage; threshold gastrointestinal damage
140 – < 240	Burdening level lung damage in 50%; burdening level tympanic membrane rupture in 90%
240 – < 290	Burdening level lung damage in 90%; lethality in 10%
≥ 290	Lethality in ≥ 50%

**Table 4-56: Primary Nuclear Blast Injury Profiles**

Time Point [hr]	Insult Range			
	50 – < 140 kPa	140 – < 240 kPa	240 – < 290 kPa	≥ 290 kPa
0.25	2	3	3	4*
30	2	2	3	
40	1	2	3	
192	0	1	3	
288	0	1	2	
408	0	0	1	
696	0	0	0	

\* According to the default value for  $T_{\text{death-CN-SL4}}$ , death would be modeled at this point.

**Table 4-57: Primary Nuclear Blast Medical Treatment Outcome Reporting**

Insult Range [kPa]	DOW*	CONV*	RTD*
50 – < 140	0%	0%	Day 9: 100%
140 – < 240	0%	0%	Day 17: 100%
240 – < 290	0%	0%	Day 29: 100%
If $T_{\text{MTF}} \leq T_{\text{death-CN-SL4}}$			
≥ 290	Day 2: 10%	Day 28: 20%† Day 35: 30%† Day 42: 20%†	Day 28: 5%† Day 35: 10%† Day 42: 5%†

Note: because this table applies to *primary* blast injuries, modeling of lethal tertiary effects, as described in Section 4.4.3.4 is not affected by the availability of medical treatment.

Notes for ≥ 290 kPa insult range: 1) If  $T_{\text{MTF}} > T_{\text{death-CN-SL4}}$  (as is the default—see Table 2-14), icons are KIA, so this table is not needed to estimate their outcome, and 2) personnel who become CONV have unknown or very long time until RTD, so they remain as CONV in the model.

\* Reported values indicate the fraction that changes status on a given day; they are not cumulative.

† In the personnel status table, these individuals are reported as WIA(3) on Day 2 and remain there until becoming CONV or RTD.



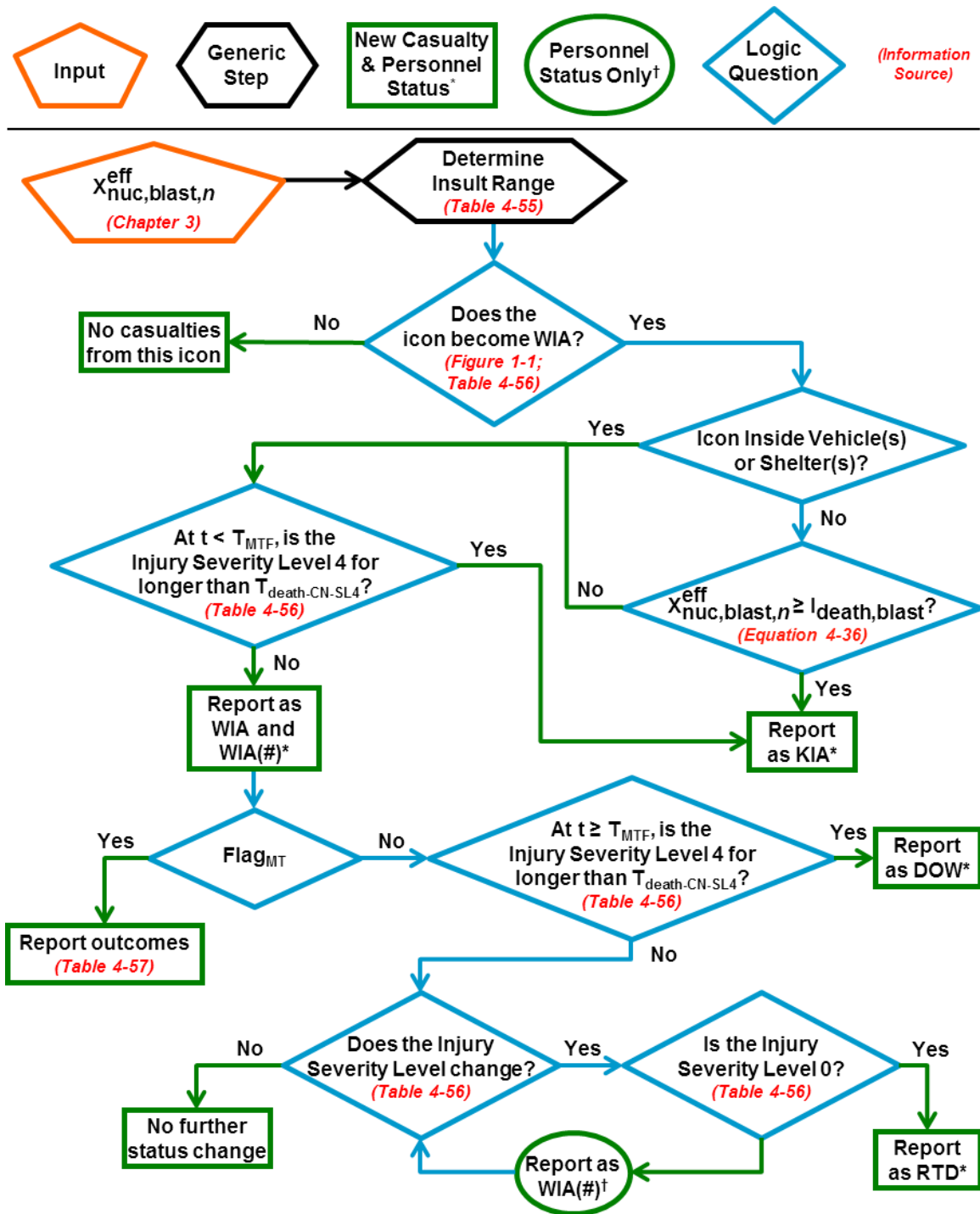

\* Casualty information ( $i_n$ , CAT,  $f_{new-CAT}$ ,  $f_{ex-CAT}$ , and d) is passed to Equations 4-18 and 4-20.  
 † Personnel status information ( $i_n$ , CAT,  $f_{new-CAT}$ ,  $f_{ex-CAT}$ , and d) is passed to Equation 4-20.

Figure 4-18: Human Response and Casualty Estimation Flowchart for Primary Nuclear Blast

#### 4.4.4. Thermal Fluence

1. Figure 4-19 summarizes the human response and casualty estimation processes for thermal fluence from a nuclear detonation.
2. Assumptions, limitations, and constraint.
  - a. Assumptions.
    - 1) Thermal fluence resulting from a nuclear detonation is quantitatively correlated to a percentage of body surface area burned, with the percentage being dependent upon the type of uniform or clothing worn and the fit of the garment.
    - 2) The Injury Profile and associated casualty category changes are independent of which body part(s) suffer(s) burns.
  - b. Limitations.
    - 1) The effects of thermal flash (such as flash blindness) are ignored.
    - 2) The percentage of body surface area burned excludes first degree (epidermal or surface) burns.
  - c. Constraint. The percentage of body surface area burned includes partial-thickness (2<sup>nd</sup> degree) and full-thickness (3<sup>rd</sup> degree) burns.
3. Each *individual's* insult due to thermal fluence ( $X_{\text{nuc,thermal},n}^{\text{eff}}$ ), expressed as percent body surface area with second or third degree burns (%BSA), is estimated according to the following unique algorithm used only for this specific application; Chapter 3 is *not* used to estimate  $X_{\text{nuc,thermal},n}^{\text{eff}}$ .

- a. First, for each icon, the number of individuals actually challenged by thermal fluence is estimated using Equation 4-37; if the icon is occupying a vehicle or shelter when the nuclear weapon detonates, only a fraction of the personnel in the icon is estimated to be challenged by thermal fluence.

$$i_{\text{nuc,therm},n} = P_{\text{trans}} \cdot i_n, \quad (4-37)$$

where:

$i_{\text{nuc,therm},n}$  is the number of individuals in icon  $n$  that are actually challenged by thermal fluence (note: this value is passed to Equation 4-18 instead of  $i_n$ ),

$P_{\text{trans}}$  is the thermal transmission probability for the specific vehicle or shelter the icon occupies (see Table 4-58), and

$i_n$  is the number of individuals in icon  $n$ .

**Table 4-58: Recommended Thermal Transmission Probabilities for Various Vehicle and Shelter Types**

Vehicle/Shelter Thermal Class	Thermal Transmission Probability ( $P_{trans}$ ) <sup>*</sup>	
	Unwarned	Warned
Armored Personnel Carrier – Closed	0.00	0.00
Armored Personnel Carrier – Moving	0.50	0.00
Armored Personnel Carrier – Open	1.00	0.00
Earth Shelter	0.75	0.05
Exposed/Dismounted	1.00	1.00
Foxhole	1.00	0.05
Light Truck	0.90	0.50
Masonry Building – Few Windows	0.10	0.00
Masonry Building – Many Windows	0.25	0.00
Multi-Story Brick Building	0.25	0.00
Panel Van	0.05	0.00
Semi-Trailer Van	0.90	0.90
Tank – Defense	0.50	0.00
Tank – Movement	0.75	0.00
Tank – Offense	0.00	0.00
Tent	0.25	0.25
Truck	0.90	0.90
Truck in Revetment	0.50	0.05
Wood Frame Building	0.25	0.05

\* The values in this table are from subject matter expert estimates during the development of AMedP-8(A). “Correct” values tend to have limited distribution or be classified. Users are encouraged to use other values based on operational test data, as available, or other NATO sources such as AEP-4.<sup>72</sup> Values from AEP-4 are not included here because they are classified.

b. Second, Equation 4-38 is used to estimate the thermal fluence insult ( $X_{nuc,thermal,n}^{eff}$ ) to the individuals within the icon that are challenged.<sup>73</sup> Equation 4-38 is dependent upon the CBRN Challenge and thermal fluence thresholds that vary by uniform/IPE. The user may instead provide specific values of  $X_{nuc,thermal,n}^{eff}$  for each icon.

$$X_{nuc,thermal,n}^{eff} = \frac{\arccos\left(\frac{Q_{T,uniform,n}}{X_{nuc,thermal,n}}\right)}{\pi} \cdot P\%_{uniform,n} + \frac{\arccos\left(\frac{Q_{T,skin}}{X_{nuc,thermal,n}}\right)}{\pi} \cdot P\%_{skin,n}, \quad (4-38)$$

where:

$X_{nuc,thermal,n}^{eff}$  is the thermal fluence insult for icon  $n$  [%BSA],

<sup>72</sup> NATO, AEP-4.

<sup>73</sup> Sheldon G. Levin, *The Effect of Combined Injuries from a Nuclear Detonation on Soldier Performance* (Española, NM: Technical Southwest, Inc., 1993), 24.

$\arccos$  is the arccosine,<sup>74</sup> expressed in radians (not degrees),

$Q_{T,uniform}$  is the thermal fluence threshold for a partial-thickness (second degree) burn for the uniform type worn by icon  $n$ <sup>75</sup> [kJ/m<sup>2</sup>] (Table 4-59),

$Q_{T,skin}$  is the thermal fluence threshold value for bare skin for a partial-thickness (second degree) burn [kJ/m<sup>2</sup>] (Table 4-59),

$X_{nuc,thermal,n}$  is the thermal fluence that challenges icon  $n$  [kJ/m<sup>2</sup>] (derived from the output of the user's national hazard prediction model),

$P_{uniform,n}^{\%}$  is the percentage of the body covered by the uniform for icon  $n$ ,<sup>76</sup> and

$P_{skin,n}^{\%}$  is the percentage of the body that is bare for icon  $n$ .

**Table 4-59: Thermal Fluence Threshold Values for Partial-Thickness (Second Degree) Burns for Various Uniform Types**

Uniform/Clothing	Threshold Thermal Fluence ( $Q_T$ ) [kJ/m <sup>2</sup> ]
Bare Skin	109
Battledress Uniform (BDU) + T-shirt	310
BDU + T-shirt + Airspace <sup>†</sup>	630
Battledress Overgarment (BDO)	420
BDO + Airspace <sup>†</sup>	670
BDO + BDU + T-shirt	1300
BDO + BDU + T-shirt + Airspace <sup>†</sup>	2010

\* Anthony J. Baba et al., *Incidence of Skin Burns under Contemporary Army Uniforms Exposed to Thermal Radiation from Simulated Nuclear Fireballs*, HDL-TR-2084 (Adelphi, MD: U.S. Army Laboratory Command, Harry Diamond Laboratories, December 1986), 24, Table 4; and Levin, *Effect of Combined Injuries*, 24.

† Airspace indicates looser clothing (i.e., clothing with airspace between the body and the garment), as opposed to fitted clothing.

4. For each thermal fluence insult range, Table 4-60 summarizes the associated symptoms, Table 4-61 fully describes the associated Injury Profile for untreated personnel, and Table 4-62 describes the outcomes associated with medical treatment.

<sup>74</sup> Note that the arccosine is undefined if the argument is  $> 1$ . Thus, for thermal insults ( $X_{nuc,thermal,n}^{term}$ ) below the relevant threshold ( $Q_{T,uniform}$  or  $Q_{T,skin}$ ), the corresponding arccosine term becomes zero. If both terms become zero for this reason, then the icon is not injured by thermal effects.

<sup>75</sup> Typically assumed to be "BDU+T-shirt."

<sup>76</sup> Typically assumed to be 88% for unwarned cases and 100% for warned cases.

**Table 4-60: Thermal Fluence Insult Ranges**

Insult Range [%BSA]	Description*
< 1	No observable injury†
1 – < 10	1 <sup>st</sup> , 2 <sup>nd</sup> and possible 3 <sup>rd</sup> degree burns; electrolyte imbalance; pain
10 – < 20	Upper GI discomfort; 1 <sup>st</sup> , 2 <sup>nd</sup> and possible 3 <sup>rd</sup> degree burns; electrolyte imbalance; increased pain
20 – < 30	Upper GI discomfort; 1 <sup>st</sup> , 2 <sup>nd</sup> and possible 3 <sup>rd</sup> degree burns; fluid loss; decreased renal blood flow; compromise of the immune system; pain; lethality in 10%
≥ 30	Upper GI discomfort; 2 <sup>nd</sup> and 3 <sup>rd</sup> degree burns; hypovolemia; decreased renal blood flow; shock resulting from blood pressure decrease; cardiac distress; toxemia; multiple organ failure; lethality in ≥ 50%

\* Estimation of burn lethality is approximate.

† < 1 %BSA may include a larger area of 1st degree burns.

**Table 4-61: Thermal Fluence Injury Profiles**

Time Point [hr]	Insult Range			
	1 – < 10 %BSA	10 – < 20 %BSA	20 – < 30 %BSA	≥ 30 %BSA
0.1	1	2	3	3
24	1	2	3	4*
48	2	2	3	
336	0	1	3	

\* According to the default value for  $T_{\text{death-CN-SL4}}$ , death would be modeled at this point.

**Table 4-62: Thermal Fluence Medical Treatment Outcome Reporting**

Insult Range [%BSA]	DOW*	CONV*	RTD*
1 – < 10	0%	0%	Day 15: 100%
10 – < 20	0%	0%	Day 23: 100%
20 – < 30	0%	Day 33: 50%	Day 33: 50%
30 – < 45	Day 9: 30%	Day 44: 70%	0%
≥ 45	Day 9: 50%	Day 51: 50%	0%

\* Reported values indicate the fraction that changes status on a given day; they are not cumulative.

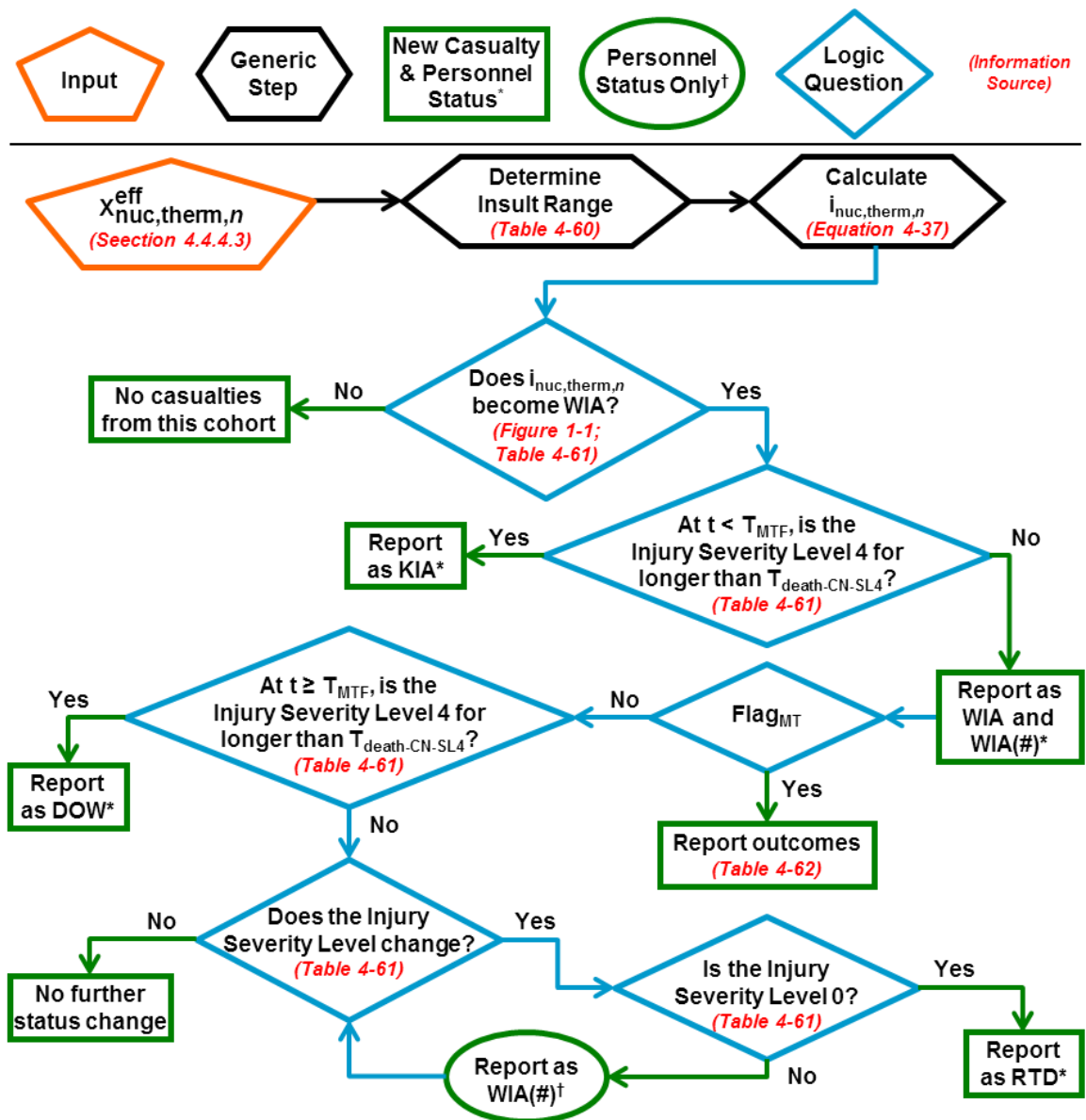

\* Casualty information ( $i_{nuc,therm,n}$ , CAT,  $f_{new-CAT}$ ,  $f_{ex-CAT}$ , and d) is passed to Equations 4-18 and 4-20.  
 † Personnel status information ( $i_{nuc,therm,n}$ , CAT,  $f_{new-CAT}$ ,  $f_{ex-CAT}$ , and d) is passed to Equation 4-20.

Figure 4-19: Human Response and Casualty Estimation Flowchart for Thermal Fluence From a Nuclear Detonation

## CHAPTER 5    BIOLOGICAL HUMAN RESPONSE AND CASUALTY ESTIMATION

This chapter begins with a discussion of assumptions and limitations that apply only to biological agents. Following that are full descriptions of the separate non-contagious and contagious disease human response and casualty estimation modeling *frameworks*. The chapter concludes with disease-specific sections describing how the methodology uses the Effective CBRN Challenge to estimate human response and casualties, including one flowchart per non-contagious disease that summarizes the process. For contagious diseases, there are separate isolation/quarantine and contagious sections, so that a user may choose to model the disease as if it is non-contagious. In short, this chapter discusses the RESPONSE and STATUS steps of the methodology for biological agents.

### 5.1.    BIOLOGICAL AGENT MODEL FRAMEWORK

#### 5.1.1.    Human Response Submodels

1.    In contrast to CRN, human response to biological agents is modeled using population-based estimates of injury severity over time. Thus, the total number of casualties and their distribution over time are known, but the status of any particular icon or individual is unknown.
2.    The non-contagious human response model comprises five submodels: infectivity/effectivity,<sup>77</sup> incubation/latent period,<sup>77</sup> duration of illness, lethality, and Injury Profile. Each biological challenge type has a unique set of the five submodels.
  - a.    Infectivity/Effectivity: estimates the fraction of each icon that will become ill (symptomatic), as a function of the icon's inhaled dose ( $X_{Q,n}^{eff}$ , estimated in Chapter 3). To avoid miscounting, the estimated number of ill individuals for each icon is *not* rounded to the nearest integer; a decimal number of people is reported from each icon.<sup>78</sup> This submodel may be characterized by an inhaled dose-dependent probability distribution or a threshold inhaled dose.
  - b.    Incubation/Latent Period: estimates the daily number of individuals who will complete the incubation or latent period and therefore manifest symptoms and enter the first stage of (symptomatic) illness. This submodel is characterized by the probability of becoming symptomatic as a function of time. It may be

<sup>77</sup> For replicating organisms, infectivity and incubation period are used. For toxins, effectivity and latent period are used.

<sup>78</sup> Because the models are intended for application at the *population* level, the estimated decimal number of personnel from each icon must *not* be used as point estimates; the results should *only* be used at the population (aggregate) level.

represented by a dose-dependent or dose-independent probability distribution or fixed value.

- c. Duration of Illness: estimates the daily number of individuals who move from one stage of illness to the next, DOW, become CONV, and become RTD, as applicable. This submodel is characterized by the probability of moving to the next stage, becoming DOW, becoming CONV, or becoming RTD, as a function of time. It may be represented by one or more dose-dependent or dose-independent probability distributions or fixed values. Separate submodels may exist for survivors and non-survivors, and for treated and untreated populations.
  - d. Lethality: estimates the number of individuals who will die. This submodel may be characterized by an inhaled dose-dependent probability distribution that is applied individually to each challenged icon,<sup>79</sup> or by a case fatality rate (CFR) that is applied once to the entire ill population (as determined by the infectivity model). Additionally, separate submodels may exist for untreated and treated populations.
  - e. Injury Profile: estimates the severity of the signs and symptoms associated with each stage of illness. This submodel is characterized by an assigned Injury Severity Level for each stage of illness. There may be separate submodels for survivors and non-survivors, and for treated and untreated populations.
3. The contagious human response model comprises the same five submodels plus two additional parameters related to person-to-person transmission of disease, the relative infectiousness,  $\alpha$ , and the time-varying disease transmission rate,  $\beta(d)$ .
  4. Consideration of medical countermeasures has different effects, depending upon the challenge. Prophylaxis may reduce the probability that an individual will become ill, reduce mortality, result in milder forms of illness, and/or speed recovery. Treatment may reduce mortality, mitigate the severity of injury, and/or decrease the duration of illness.
  5. For the untreated models (Flag<sub>MT</sub> = NO), all individuals follow a known progression through the stages of disease. Thus, the Injury Severity Level can be tracked over time, such that the personnel status output table will reflect stage-wise changes in severity until the final outcome (DOW, CONV, or RTD).
  6. For some of the treated models (Flag<sub>MT</sub> = Yes), particularly for bacterial agents, the exact progression of disease over time in those who survive as a result of treatment is not specified. Rather, only the total time of illness after the initiation of

---

<sup>79</sup> Because the models are intended for application at the *population* level, the estimated number of personnel from each icon must *not* be used as point estimates; the results should *only* be used at the population (aggregate) level.



treatment is specified. In these cases, the personnel status output table will not reflect all the stages of disease—individuals will remain in the status they were in when treatment began, and then will be reported as DOW, CONV, or RTD.

### 5.1.2. Casualty Estimation

For biological agents, no general rule determines whether and when a casualty will change status—see Section 5.2 for disease-specific models.

### 5.1.3. Assumptions and Limitations

1. Assumptions.
  - a. All challenges relate to inhalation of the aerosolized agent.
  - b. The efficacy of prophylaxis and medical treatment are independent of the dose; no “defeat dose” exists.
  - c. A CFR of 1% or below is negligible; a CFR of 0% will be used. Similarly, in the absence of a well-quantified CFR, 0% or 100% lethality is used in place of qualitative descriptions such as “highly lethal without treatment” or “rarely fatal.”
  - d. Because of the relatively long incubation/latent periods and durations of illness (as compared to the time required to reach a MTF), biological agents will not cause KIAs.
  - e. The period during which an individual is ill are subdivided into one or more stages, and Injury Severity Levels related to signs and symptoms are associated with these stages.
2. Limitations
  - a. The methodology uses population-based estimates of injury severity over time. Thus, the casualty category of a particular icon *cannot* be tracked over time.
  - b. The infectivity models were derived such that the methodology ignores “subclinical” infections; everyone who is “infected” will become symptomatic. Likewise, the effectivity models were derived such that the “effect” is the onset of signs and symptoms.

### 5.1.4. Non-Contagious Casualty Estimation

1. Figure 5-1 summarizes the non-contagious biological casualty estimation process. The text in this section explains the process more fully.

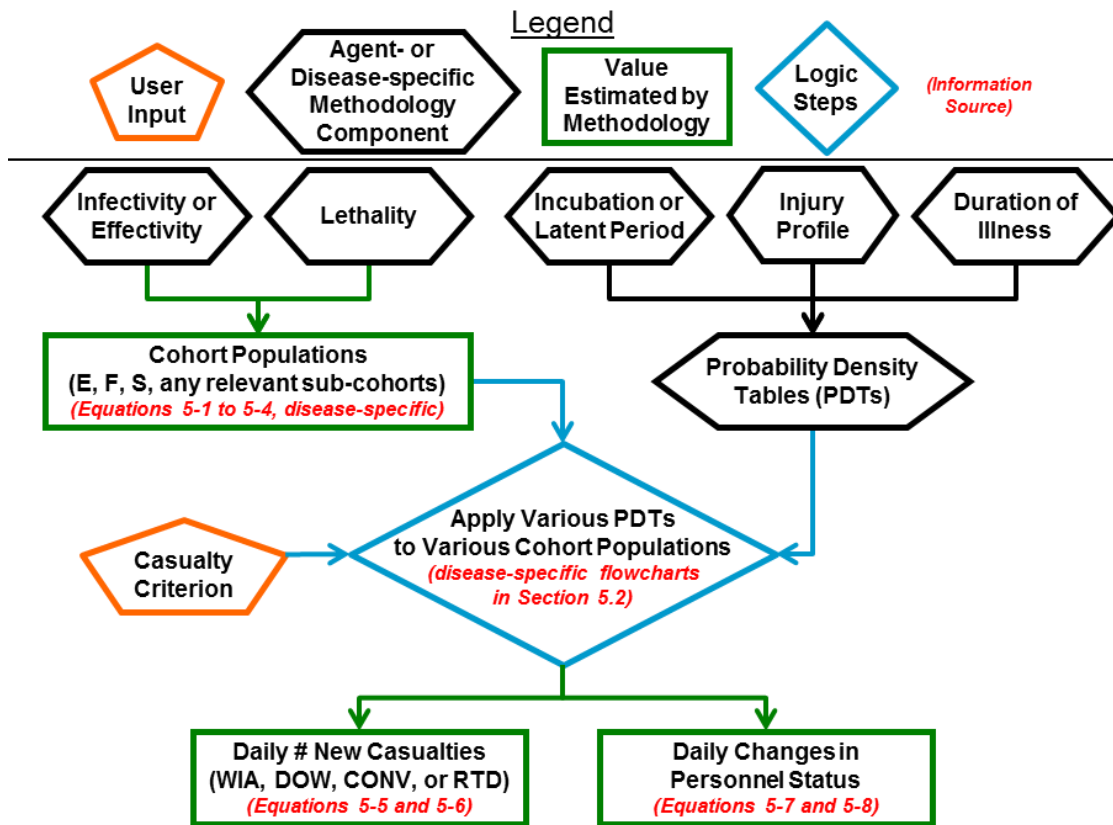

**Figure 5-1: Non-Contagious Agent/Disease Casualty Estimation Flowchart**

2. The first step is to use the infectivity/effectivity and lethality submodels for the challenge agent to estimate the number of individuals expected to become ill (E), the number of ill individuals expected to die (F), and the number of ill individuals expected to survive (S). These separate populations are referred to as cohorts.

- a. The population of the E cohort is estimated using Equation 5-1, which sums the number of infected personnel by icon after accounting for prophylaxis.

$$E = \sum_n \left( i_n \cdot (1 - \rho_n) \cdot p_E(X_{Q,n}^{\text{eff}}) \right), \quad (5-1)$$

where:

$i_n$  is the number of individuals in icon  $n$ ,

$\rho_n$  is the efficacy of prophylaxis against the challenge agent for all individuals at icon  $n$  [unitless, ranges from 0 to 1],

$X_{Q,n}^{\text{eff}}$  is the inhaled dose, which is estimated according to Chapter 3, and

$p_E(X_{Q,n}^{\text{eff}})$  is the probability that an individual who did not receive prophylaxis and inhaled a dose of  $X_{Q,n}^{\text{eff}}$  will become ill (estimated using the infectivity/effectivity submodel parameter values for the challenge agent

with the appropriate equation given in Section 5.1.6).

b. The F cohort population is estimated using one of two equations, depending upon the type of lethality model associated with the challenge type.

- 1) If the lethality model is an inhaled dose-dependent probability distribution, Equation 5-2 is used to estimate the population of the F cohort; it sums the number of personnel in each icon who received a lethal dose after accounting for prophylaxis.

$$F = \sum_n (i_n \cdot (1 - \rho_n) \cdot p_f(X_{Q,n}^{\text{eff}})), \quad (5-2)$$

where:

$i_n$ ,  $\rho_n$ , and  $X_{Q,n}^{\text{eff}}$  are as defined for Equation 5-1, and

$p_f(X_{Q,n}^{\text{eff}})$  is the probability that an individual who did not receive prophylaxis and inhaled a dose of  $X_{Q,n}^{\text{eff}}$  will die (estimated using the lethality submodel parameter values for the challenge agent with the appropriate equation given in Section 5.1.6<sup>80</sup>).

- 2) If the lethality model is a fixed CFR, Equation 5-3 is used to estimate the population of the F cohort; it is a simple percentage of the ill.

$$F = E \cdot p_f(Q), \quad (5-3)$$

where  $p_f(Q)$  is the probability that an ill individual will die (determined by the lethality submodel for the challenge agent).

c. The population of the S cohort is estimated using Equation 5-4.

$$S = E - F \quad (5-4)$$

d. For a given disease, the F and S cohorts may be split into sub-cohorts for several reasons. The specific cohorts/sub-cohorts used with each disease are fully described in the appropriate disease-specific part of Section 5.2.

- 1) The effects of medical treatment. For example, if the provision of medical treatment changes the duration of illness, the S and F cohorts might be split between the  $S_U$ ,  $S_T$ ,  $F_U$ , and  $F_T$  sub-cohorts, where the “U” cohorts relate to those who finish their course of disease before specific treatment is available, and the “T” cohorts relate to those who received specific treatment.

---

<sup>80</sup> Note that this type of lethality model is defined such that  $p_E(X_{Q,n}^{\text{eff}}) \geq p_f(X_{Q,n}^{\text{eff}})$  for all  $X_{Q,n}^{\text{eff}}$ .

- 2) The day on which antibiotic or antitoxin treatment begins ( $d_{\text{trt-Q}}$ ). In this case, an individual's stage of illness on  $d_{\text{trt-Q}}$  is used as the basis for splitting S and F. For example, if the duration of illness differs based on whether treatment starts in Stage 1 or Stage 2, the F cohort might be split into the  $F_U$ ,  $F_{T-1}$ , and  $F_{T-2}$  sub-cohorts ( $F_U$  is used because some individuals may die before treatment begins).
- 3) Unique features of the disease. For example, if a disease can present in two distinct ways, A and B, the S cohort may be split into the  $S_A$  and  $S_B$  sub-cohorts.

3. The next step in the methodology is to estimate the *daily* fraction of each cohort that is in each casualty category, which allows estimation of the number of new casualties and of personnel status. To do this, the methodology uses the cohort populations and disease-specific probability density tables (PDTs) derived from the incubation period and duration of illness models.

4. A single PDT describes the distribution of times at which a specific cohort that is ill with a specific disease enters a specific casualty category. For example, one PDT specifies when individuals ill with melioidosis enter Stage 1 of disease and become WIA(3). Each disease has multiple PDTs, and the full set of PDTs for a single disease describes the times at which all changes in casualty category occur. The set of PDTs needed to describe all changes in casualty category is different for each disease.

5. PDTs contain the results of integrating the appropriate probability density function (PDF) over the *interval* of the specified day. *The user does not need to generate any PDTs* unless changes are made to the underlying submodels for a specific disease.

- a. For PDTs reflecting the onset of Stage 1 of illness,<sup>81</sup> the appropriate PDF is the PDF of the distribution used to characterize the incubation/latent period.
- b. For all other PDTs for the same disease, the appropriate PDF is a convolution of multiple PDFs. For example, if non-survivors of the disease enter Stage 1, then Stage 2, and then DOW at the end of Stage 2, the PDT for the daily fraction of non-survivors (F) that DOW will contain numbers derived by convolving the PDFs associated with the incubation/latent period and the durations of Stages 1 and 2 of illness.
- c. Table 5-1 is an example PDT.

---

<sup>81</sup> Such PDTs have titles in the format of "Daily Fraction of People Ill with (Disease) Who Become WIA, for Casualty Criterion WIA(X+)."

**Table 5-1: Example PDT, “Daily Fraction of Non-Survivors (F) III with Example Disease Who DOW”**

Day	Fraction
1	0.5000
2	0.2276
3	0.1432
4	0.0747
5	0.0432
6	0.0113

Note: the numbers in this table are purely notional and do not reflect any real disease.

6. The set of PDTs for a given disease dictates all changes in casualty category *during* a given day. This information must be applied carefully if the reporting rules from Section 1.6.4.3 are to be followed. As applied to biological agents, those rules are:

- a. Individuals who become WIA on day X must be reported as WIA on day X.
- b. Individuals who move from WIA to DOW, CONV, or RTD on day X must be reported as WIA on day X and DOW, CONV, or RTD on day X+1.
- c. Individuals who move from CONV to RTD on day X must be reported as CONV on day X and RTD on day X+1.
- d. For the personnel status table, any individual reported as WIA on a day must be reported based on the maximum severity of injury on that day—the # in WIA(#) must be the highest value that occurred that day.

7. To determine the daily *number* of new WIA, DOW, CONV, or RTD, the *fraction* associated with the desired day within the appropriate PDT is simply multiplied by the appropriate cohort population. The flowcharts in Section 5.2 all note that information regarding cohort populations ( $Pop_{\text{cohort}}$ ), casualty category (CAT), and the appropriate PDT, are passed to Equations 5-5 through 5-8, which are defined below. The flowcharts do not report day because each equation is applied for each day until the end of all PDTs. The approach below ensures that all casualties are reported as WIA on the day they become ill, and none are double-counted as also becoming DOW, CONV, or RTD that same day.

- a. For reporting of new WIA, the desired day for reporting is the day on which an individual becomes a new WIA. Thus, Equation 5-5 determines the reported number of new WIA on a given day.

$$New_{WIA}(d) = \sum_{\text{relevant cohorts}} \left( Pop_{\text{cohort}} \cdot PDT_{5-X}(d) \right), \quad (5-5)$$

where:

$New_{WIA}(d)$  is the number of individuals who are reported as new WIA on day d, rounded to the nearest integer,

$Pop_{\text{cohort}}$  is the population of a relevant cohort; the number of relevant cohorts and specific symbols used to refer to the cohorts are agent/disease-specific, but always follow the format  $E_X$ ,  $F_X$ , or  $S_X$ , where  $X$  indicates a sub-cohort (if any),

$PDT_{5-X}(d)$  is the fraction of  $Pop_{\text{cohort}}$  that becomes WIA on day  $d$ , as dictated by Table 5-X, and

the links between specific cohorts and PDTs are specified in the agent/disease-specific flowcharts in Section 5.2.

- b. For reporting of new DOW, CONV, and RTD, the desired day is the day *after* that on which an individual becomes a new DOW, CONV, or RTD. Thus, Equation 5-6 is used to determine the reported number of new DOW, CONV, and RTD on a given day.

$$New_{\text{CAT}}(d + 1) = \sum_{\text{relevant cohorts}} \left( Pop_{\text{cohort}} \cdot PDT_{5-X}(d) \right), \quad (5-6)$$

where:

CAT is a casualty category (DOW, CONV, or RTD),

$New_{\text{CAT}}(d + 1)$  is the number of individuals who are *reported* as new CAT on day  $d + 1$ , rounded to the nearest integer,

$Pop_{\text{cohort}}$  is as defined for Equation 5-5,

$PDT_{5-X}(d)$  is the fraction of  $Pop_{\text{cohort}}$  that *becomes* CAT on day  $d$ , as dictated by Table 5-X, and

the links between specific cohorts and PDTs are specified in the agent/disease-specific flowcharts in Section 5.2.

8. Once the daily new casualty estimate has been produced, the daily personnel status estimate—total numbers of casualties reported in each category on each day—can be produced, using Equations 5-7 and 5-8.

$$\begin{aligned} Tot_{\text{WIA}(\#)}(d) = Tot_{\text{WIA}(\#)}(d - 1) + \sum_{\text{entering}} \left( Pop_{\text{cohort}} \cdot PDT_{5-X}(d) \right) \\ - \sum_{\text{exiting}} \left( Pop_{\text{cohort}} \cdot PDT_{5-X}(d \text{ or } d - 1) \right), \end{aligned} \quad (5-7)$$

$$\begin{aligned} Tot_{\text{CAT}}(d) = Tot_{\text{CAT}}(d - 1) + \sum_{\text{entering}} \left( Pop_{\text{cohort}} \cdot PDT_{5-X}(d - 1) \right) \\ - \sum_{\text{exiting}} \left( Pop_{\text{cohort}} \cdot PDT_{5-X}(d - 1) \right), \end{aligned} \quad (5-8)$$

where:

CAT,  $\text{Pop}_{\text{cohort}}$ , and  $\text{PDT}_{5-X}(d)$  are as defined for Equations 5-5 and 5-6,

$\text{Tot}_{\text{WIA}(\#)}(d)$  is the number of individuals who are reported as WIA(#) on day  $d$ , rounded to the nearest integer,

$\text{Tot}_{\text{CAT}}(d)$  is the number of individuals who are *reported* as CAT on day  $d$ , rounded to the nearest integer,

the links between specific cohorts and a PDTs are specified in the agent/disease-specific flowcharts in Section 5.2, and

in Equation 5-7, the last PDT reference's argument is "d or d - 1"; if the exiting cohort moves to a different WIA(#),  $d$  should be used, and if the exiting cohort moves to DOW, CONV, or RTD,  $d - 1$  should be used.

9. Using the example values from Table 5-1 and assuming 100 people are in the F cohort, the number of people who are reported DOW on day 6 is:

$$\text{New}_{\text{DOW}}(6) = F \cdot \text{PDT}_{5-1}(5) = 100 \cdot 0.0432 = 4.32 = 4$$

10. After Equations 5-5 through 5-8 are applied to each casualty category on each day, the methodology continues by reporting the outputs, as described in Chapter 6.

### 5.1.5. Contagious Casualty Estimation

1. The contagious disease model described in this section was designed for the two diseases included in this document—pneumonic plague and smallpox. Attempting to apply it to any other disease could result in odd casualty estimates, and is not recommended. However, modifying the values of the parameter values for plague (Table 5-56) or smallpox (Table 5-84), to reflect national data, has been tested and is acceptable.

2. The contagious model comprises the five submodels described in Section 5.1.1.2, plus two additional submodels related to person-to-person transmission. The seven submodels are used to define the values of parameters that are incorporated into the framework of an epidemic model—the Susceptible, Exposed and infected, Infectious, Removed, and Prophylaxis efficacious (SEIRP) model.

3. The SEIRP model involves sequentially solving a set of time-dependent finite-difference equations. The sequence of equations is solved once for each time step. To match the output time resolution of the overall casualty estimation methodology, the time step in the SEIRP model is 1 day.

4. The SEIRP model employs a number of cohorts, each representing a time-varying population, to describe the dynamics of an epidemic. The cohorts are defined in the following list. The sum of all other cohorts always equals  $N_{\text{TOT}}$ , the population at risk (the value of which is calculated by Equation 6-1).

- a. The susceptible cohort,  $S(d)$ , contains individuals who are not infected, but

can become infected, on day  $d$ .

- b. The exposed and infected cohort,  $E(d)$ , contains individuals who are infected but not yet symptomatic (incubating) on day  $d$ .  $E(d)$  is divided into two sub-cohorts ( $E_1(d)$  and  $E_2(d)$ ) for the purpose of allowing a minimum incubation period in the model.
  - c. The infectious cohort,  $I(d)$ , contains individuals who are symptomatic and potentially contagious on day  $d$ .  $I(d)$  is divided into sub-cohorts ( $I_1(d)$  and  $I_2(d)$ ) for Stage 1 and Stage 2 of disease, respectively. Each cohort is associated with a specific Injury Severity Level, based on the Injury Profile for the challenge agent.
  - d. The removed cohort,  $R(d)$ , contains individuals who were contagious, but are no longer contagious on day  $d$ .  $R(d)$  is divided into sub-cohorts for individuals who have died from disease (DOW) and are thereby removed as a source of infection from the model ( $R_{DOW}(d)$ ), those who are symptomatic but recovering, will survive, and are no longer contagious ( $R_S(d)$ ), and those who have completed their recovery and are eligible to RTD ( $R_{RTD}(d)$ ).
  - e. The prophylaxis efficacious cohort,  $P(d)$ , contains individuals who have received efficacious prophylaxis, and are thereby protected against infection on day  $d$ .
5. The finite difference equations below define how individuals move between cohorts. Individuals may move among  $S(d)$ ,  $E(d)$ , and  $P(d)$ , but once an individual reaches  $I(d)$ , s/he may only move to an  $R(d)$  sub-cohort. The daily solutions to the finite-difference equations provide the population of each cohort at the end of each day. The populations are then used to generate the casualty estimate, as described in Chapter 6.
6. The finite-difference equations use the following parameters as inputs. The values of parameters with agent-specific values can be found in Section 5.2.6 (plague) and Section 5.2.10 (smallpox). For parameters that require user input, Table 5-2 contains guidance for the user.
- a.  $i_n$  is the number of individuals in icon  $n$ .
  - b.  $N_{TOT}$  is the total population of the PAR.
  - c.  $X_{Q,n}^{eff}$  is the inhaled dose, which is estimated according to Chapter 3.
  - d.  $p_E(X_{Q,n}^{eff})$  is the probability that an individual who did not receive prophylaxis and inhaled a dose of  $X_{Q,n}^{eff}$  will become ill (estimated using the infectivity submodel parameter values for the challenge agent with the appropriate equation given in Section 5.1.6).



- e.  $\rho_S$  is the efficacy of prophylaxis in  $S(d)$ , or pre-exposure prophylaxis [%].
- f.  $\rho_E(d_{p-on})$  is the efficacy of prophylaxis in  $E(d)$ , or post-exposure prophylaxis [%]. It is a function of  $d_{p-on}$  because smallpox vaccination efficacy wanes with time since exposure.<sup>82</sup>
- g.  $\mu_{E1}$  serves a dual purpose: it is the minimum time individuals infected by the CBRN incident spend incubating (in  $E_1(d)$ ), and it is the *mean* time all individuals who become ill as a result of contagious spread of disease spend incubating (in  $E_1(d)$ ) [days].
- h.  $\mu_{E2}$  is the mean time individuals spend in  $E_2(d)$  [days].
- i.  $\mu_1$  is the mean time individuals spend in  $I_1(d)$  [days].
- j.  $\mu_2$  is the mean time individuals spend in  $I_2(d)$  [days].
- k.  $\mu_{RS}$  is the fixed (constant) time individuals spend in  $R_S(d)$  [days].
- l.  $\alpha$ , the relative infectiousness, is the time-invariant proportion of individuals in  $I_1(d)$  who can transmit the disease to individuals in  $S(d)$  (and  $1-\alpha$  is the time-invariant proportion of individuals in  $I_2(d)$  who can transmit the disease to individuals in  $S(d)$ ).<sup>83</sup>
- m.  $\beta(d)$  is the time-varying rate of disease transmission [# new cases per infectious person per day.]
- n.  $d_{p-on}$  is the user-specified day on which prophylaxis is initiated (also referred to by the agent-specific variables,  $d_{trt-plag}$  and  $d_{vac-spox}$ ). The related parameter,  $v_{on}(d)$ , equals 1 when its argument =  $d_{p-on}$ , and 0 otherwise.
- o.  $d_{p-off}$  is the user-specified day on which prophylaxis ends. The related parameter,  $v_{off}(d)$ , has value 1.0 when its argument =  $d_{p-off}$  and value 0 otherwise.  $d_{p-off}$  and  $v_{off}(d)$  are used for antibiotic prophylaxis, which has a specific duration. Post-exposure vaccination, on the other hand, does not have

---

<sup>82</sup> Ideally a different prophylaxis efficacy would be applied to different sub-cohorts based on how long they had been incubating when vaccination was applied, but it is not possible to track that information with the AMedP-7.5 SEIRP model. Instead, a single time-dependent efficacy is applied to the entire population, which may lead to an overestimate of casualties for  $d_{p-on} >$  the minimum incubation period.

<sup>83</sup> If  $\alpha = 1$ , all transmission-caused new infections are due to individuals in  $I_1(d)$ . If  $\alpha = 0$ , all transmission-caused new infections are due to individuals in  $I_2(d)$ . If  $\alpha = 0.15$ , the number of new transmission-caused infections at any time-step is associable with 15% of the population of  $I_1(d)$  and 85% of the population of  $I_2(d)$ .

a specific duration, so  $d_{p-off}$  should not be specified and  $v_{off}(d)$  has value 0 for all days.

- p.  $d_{trt}$  is the user-specified day on which treatment becomes available. The related parameter,  $MT_{on}(d)$ , has value 1.0 when its argument is  $\geq d_{trt}$  and value 0 for all other days. After day  $d_{trt}$ , all individuals who become WIA begin receiving treatment immediately.
- q.  $WIA_{I_1}$  is a binary parameter that indicates whether individuals in  $I_1(d)$  are declared WIA (and thus eligible to receive medical treatment); its value depends upon the user-specified casualty criterion and on the disease.<sup>84</sup> For both plague and smallpox, the Injury Severity Level associated with  $I_1(d)$  is 2. Thus, if the casualty criterion is WIA(1+) or WIA(2+),  $WIA_{I_1} = 1$ , and if the casualty criterion is WIA(3+),  $WIA_{I_1} = 0$ .
- r.  $MT_{I_1}$  is a binary parameter that indicates whether medical treatment causes ill personnel in Stage 1 to no longer transmit disease, despite remaining symptomatic. Thus, it is used to determine whether WIAs who receive treatment move from  $I_1(d)$  to  $R_S(d)$ .<sup>85</sup>
- s.  $p_f(d)$  is the CFR. It is a function of day because for smallpox, the value is a function of days since vaccination of the force (per Table 5-78). The efficacy of antibiotics for preventing deaths from plague is accounted for elsewhere.

**Table 5-2: Factors to Consider for User-Specified Parameters**

Parameter	Considerations
$d_{p-on}$	National doctrine on vaccination (for pre-exposure prophylaxis) Expected time from incident to detection/identification (materiel, onset of illness) Availability of prophylaxis materiel
$d_{p-off}$	Duration of expected course of antibiotics or antivirals
$d_{trt}$	Expected time from incident to detection/identification (materiel, onset of illness) Availability of medical treatment resources at point of need (logistics)

7. Figure 5-2 shows which parameters interact with which cohorts.

<sup>84</sup> There is no  $WIA_{I_2}$  parameter because the Injury Severity Level for  $I_2(d)$  for both plague and smallpox is sufficiently high that the value of  $WIA_{I_2}$  would always be 1.

<sup>85</sup> There is no  $MT_{I_2}$  parameter because the value would be zero for both plague and smallpox.

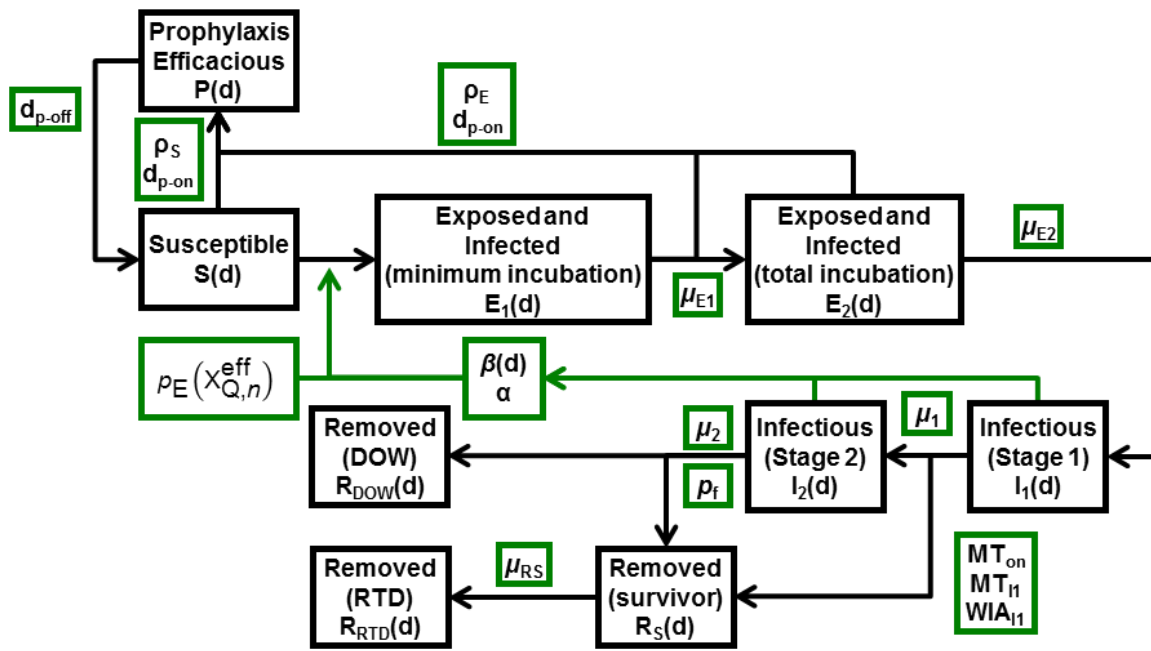

Figure 5-2: Interaction of SEIRP Cohorts and Parameters

8. The populations of the P, E<sub>1</sub>, and S cohorts on day zero (d = 0) are initialized by Equations 5-9 through 5-11. The I and R cohorts are assumed to have an initial population of zero.

$$P(0) = \sum_n (i_n \cdot \rho_s) \tag{5-9}$$

$$E_1(0) = \sum_n (i_n \cdot (1 - \rho_s) \cdot \rho_E(x_{Q,n}^{eff})) \tag{5-10}$$

$$S(0) = N_{TOT} - P(0) - E(0) \tag{5-11}$$

9. Next, Equations 5-12 through 5-24 are sequentially solved for each day of interest. The final day of interest is the day at which  $\beta(d)$  becomes zero and remains there, plus the average time-course of disease ( $\mu_{E1} + \mu_{E2} + \mu_1 + \mu_2$ ).

$$P(d) = P(d-1) \cdot (1 - v_{off}(d-1)) + v_{on}(d-1) \cdot (\rho_s \cdot S(d-1) + \rho_E(d_{p-on}) \cdot E(d-1)) \tag{5-12}$$

$$S(d) = S(d-1) \cdot (1 - \rho_s \cdot v_{on}(d-1)) \cdot \left(1 - \frac{\beta(d-1) \cdot (\alpha \cdot I_1(d-1) + (1-\alpha) \cdot I_2(d-1))}{N_0}\right) + v_{off}(d-1) \cdot P(d-1) \tag{5-13}$$

If  $d < \mu_{E1}$ ,

$$\dots \quad E_1(d) = E_1(d-1) \cdot (1 - \rho_E(d_{p-on}) \cdot v_{on}(d-1)) \quad (5-14)$$

---

$$E_2(d) = 0 \quad (5-15)$$

**If  $d = \mu_{E1}$ ,**

$$E_1(d) = 0 \quad (5-16)$$

---

$$E_2(d) = E_1(d-1) \cdot (1 - \rho_E(d_{p-on}) \cdot v_{on}(d-1)) \quad (5-17)$$

**If  $d > \mu_{E1}$ ,**

$$E_1(d) = E_1(d-1) \cdot (1 - \rho_E(d_{p-on}) \cdot v_{on}(d-1)) \cdot \left(1 - \frac{1}{\mu_{E1}}\right) + \frac{S(d-1) \cdot (1 - \rho_S \cdot v_{on}(d-1)) \cdot \beta(d-1) \cdot (\alpha \cdot I_1(d-1) + (1-\alpha) \cdot I_2(d-1))}{N_0} \quad (5-18)$$

---

$$E_2(d) = E_2(d-1) \cdot (1 - \rho_E(d_{p-on}) \cdot v_{on}(d-1)) \cdot \left(1 - \frac{1}{\mu_{E2}}\right) + \frac{E_1(d-1) \cdot (1 - \rho_E(d_{p-on}) \cdot v_{on}(d-1))}{\mu_{E1}} \quad (5-19)$$

---

$$I_1(d) = \left( I_1(d-1) \cdot \left(1 - \frac{1}{\mu_1}\right) + \frac{E_2(d-1) \cdot (1 - \rho_E(d_{p-on}) \cdot v_{on}(d-1))}{\mu_{E2}} \right) \cdot (1 - MT_{on}(d) \cdot MT_{I1} \cdot WIA_{I1}) \quad (5-20)$$

---

$$I_2(d) = I_2(d-1) \cdot \left(1 - \frac{1}{\mu_2}\right) + \frac{I_1(d-1)}{\mu_1} \quad (5-21)$$

---

$$R_{DOW}(d) = R_{DOW}(d-1) + \frac{I_2(d-1)}{\mu_2} \cdot p_f(d-1) \quad (5-22)$$

---

$$\begin{aligned}
 R_S(d) = & R_S(d-1) + \frac{I_2(d-1)}{\mu_2} \cdot (1 - p_f(d-1)) - \frac{I_2(d-(1+\mu_{RS}))}{\mu_2} \cdot (1 - p_f(d-(1+\mu_{RS}))) \\
 & + (MT_{on}(d) \cdot MT_{I1} \cdot WIA_{I1}) \cdot \left( I_1(d-1) \cdot \left( 1 - \frac{1}{\mu_1} \right) + \frac{E_2(d-1) \cdot (1 - \rho_E(d_{p-on}) \cdot v_{on}(d-1))}{\mu_{E2}} \right) \\
 & - (MT_{on}(d-\mu_{RS}) \cdot MT_{I1} \cdot WIA_{I1}) \\
 & \cdot \left( I_1(d-(1+\mu_{RS})) \cdot \left( 1 - \frac{1}{\mu_1} \right) + \frac{E_2(d-(1+\mu_{RS})) \cdot (1 - \rho_E(d_{p-on}) \cdot v_{on}(d-(1+\mu_{RS})))}{\mu_{E2}} \right)
 \end{aligned} \tag{5-23}$$

$$\begin{aligned}
 R_{RTD}(d) = & R_{RTD}(d-1) + \frac{I_2(d-(1+\mu_{RS}))}{\mu_2} \cdot (1 - p_f(d-(1+\mu_{RS}))) \\
 & + (MT_{on}(d-\mu_{RS}) \cdot MT_{I1} \cdot WIA_{I1}) \cdot \left( I_1(d-(1+\mu_{RS})) \cdot \left( 1 - \frac{1}{\mu_1} \right) \right. \\
 & \left. + \frac{E_2(d-(1+\mu_{RS})) \cdot (1 - \rho_E(d_{p-on}) \cdot v_{on}(d-(1+\mu_{RS})))}{\mu_{E2}} \right)
 \end{aligned} \tag{5-24}$$

10. Finally, the cohort populations, calculated according to the preceding equations, Table 5-3 gives guidance on which equations should be used to populate the output tables for pneumonic plague and smallpox.

**Table 5-3: Guidance on Using SEIRP Equations to Populate Output Tables**

CAT	Rate Table		CAT	Personnel Status Table	
	Plague	Smallpox		Plague	Smallpox
WIA	WIA(1+) or WIA(2+): Eq. 5-25 WIA(3+): Eq. 5-26		WIA(1)	None	None
			WIA(2)	Eq. 5-20	Eq. 5-20
			WIA(3)	None	Eq. 5-27
			WIA(4)	Eq. 5-21	Eq. 5-28
DOW	Eq. 5-29	Eq. 5-29	DOW	Eq. 5-22	Eq. 5-22
CONV	None	Eq. 5-30	CONV	None	Eq. 5-23
RTD	Eq. 5-31	Eq. 5-31	RTD	Eq. 5-24	Eq. 5-24

$$I_{1,new}(d) = \left( \frac{E_2(d-1) \cdot (1 - \rho_E(d_{p-on}) \cdot v_{on}(d-1))}{\mu_{E2}} \right) \cdot (1 - MT_{on}(d) \cdot MT_{I1} \cdot WIA_{I1}) \tag{5-25}$$

$$I_{2,new}(d) = \frac{I_1(d-1)}{\mu_1} \quad (5-26)$$

$$WIA(3)_{spox}(d) = WIA(3)_{spox}(d-1) \cdot \left(1 - \frac{1}{\mu_2}\right) + I_{2,new}(d) \cdot (1 - p_f(d-1)) \quad (5-27)$$

$$WIA(4)_{spox}(d) = WIA(4)_{spox}(d-1) \cdot \left(1 - \frac{1}{\mu_2}\right) + I_{2,new}(d) \cdot p_f(d-1) \quad (5-28)$$

$$R_{DOW,new}(d) = R_{DOW}(d) - R_{DOW}(d-1) \quad (5-29)$$

$$R_{S,new}(d) = \frac{I_2(d-1)}{\mu_2} \cdot (1 - p_f(d-1)) + (MT_{on}(d) \cdot MT_{I1} \cdot WIA_{I1}) \cdot \left( I_1(d-1) \cdot \left(1 - \frac{1}{\mu_1}\right) + \frac{E_2(d-1) \cdot (1 - \rho_E(d_{p-on}) \cdot v_{on}(d-1))}{\mu_{E2}} \right) \quad (5-30)$$

$$R_{RTD,new}(d) = R_{RTD}(d) - R_{RTD}(d-1) \quad (5-31)$$

## 11. Assumptions, limitations, and constraints.

### a. Assumptions.

- 1) The population is large and unstructured.
- 2) The population mixes homogeneously.
- 3) Initial and transmission-caused infections follow the same course of disease.
- 4) The epidemiological circumstances of the historical outbreaks from which the time-varying rate of disease transmission ( $\beta(d)$ ) was derived are similar to the circumstances in scenarios of interest to the user.
- 5) Individuals who become WIA, survive the illness (with or without medical treatment), and RTD gain immunity to the disease. Therefore, they do not re-enter the S cohort upon becoming RTD.

- b. Limitation. For agents with time-varying efficacy of post-exposure prophylaxis, in order to minimize error caused by the inability of this SEIRP model to track individuals, the day on which prophylaxis is applied is best limited to days before transmission of disease from I to S has occurred.

### c. Constraints.

- 1) Because the model uses only mean times (and not standard deviations) to represent the lengths of the incubation period and each stage of illness, it represents all probability distributions as exponential distributions.
- 2) The model uses finite-difference equations instead of differential equations and integrals (this introduces some unknown degree of inaccuracy).

### 5.1.6. Equations Needed to Execute Casualty Estimates

1. The equations presented in this section are necessary to estimate  $p_E(X_{Q,n}^{\text{eff}})$  and  $p_f(X_{Q,n}^{\text{eff}})$ , as required in Sections 5.1.4 and 5.1.5. As warranted, the agent submodel summary tables in Section 5.2 will refer to these equations.
2. Most infectivity models and some lethality models use a lognormal distribution to calculate the probability of illness or of death. Equation 5-32 may be used to calculate the values of these lognormal distributions.

$$p_E(X_{Q,n}^{\text{eff}}) \text{ or } p_f(X_{Q,n}^{\text{eff}}) = \Phi \left( PS_Q \cdot \log_{10} \left( \frac{X_{Q,n}^{\text{eff}}}{ID_{50,Q}, ED_{50,Q}, \text{ or } LD_{50,Q}} \right) \right) \quad (5-32)$$

where:

$p_E(X_{Q,n}^{\text{eff}})$  and  $p_f(X_{Q,n}^{\text{eff}})$  are the cumulative fraction of individuals at icon  $n$  who received Effective CBRN Challenge  $X_{Q,n}^{\text{eff}}$  that will become ill (for infectivity/effectivity), or that will die (for lethality),

$\Phi$  is the standard normal cumulative distribution function,

$ID_{50,Q,k}$ ,  $ED_{50,Q,k}$ , and  $LD_{50,Q,k}$  are the  $ID_{50}$ ,  $ED_{50}$ , and  $LD_{50}$ , respectively, for challenge type  $Q$  (values are agent specific—see Section 5.2),

$PS$  is the base 10 probit slope associated with the  $ID_{50}$ ,  $ED_{50}$ , or  $LD_{50}$  (values are agent specific—see Section 5.2),

3. A few infectivity models also use a threshold model to calculate the probability of illness—see Equation 5-33.

$$\begin{aligned} p_E(X_{Q,n}^{\text{eff}}) &= 1 \text{ for } X_{Q,n}^{\text{eff}} \geq T, \text{ and} \\ p_E(X_{Q,n}^{\text{eff}}) &= 0 \text{ for } X_{Q,n}^{\text{eff}} < T, \end{aligned} \quad (5-33)$$

where:

$X_{Q,n}^{\text{eff}}$  is the Effective CBRN Challenge for challenge type  $Q$  and icon  $n$ ,

$p_E(X_{Q,n}^{\text{eff}})$  is the probability that an individual who did not receive prophylaxis and inhaled a dose of  $X_{Q,n}^{\text{eff}}$  will become ill,

$T$  is the threshold value (value is agent-specific).

4. The anthrax lethality model for individuals who receive antibiotic treatment uses a linear function to compute a time-dependent CFR—see Equation 5-34.

$$\text{CFR}(d_{\text{In-Stg1}}) = m \cdot d_{\text{In-Stg1}} + b \quad (5-34)$$

where:

CFR(d) is the case fatality rate [%],

$d_{\text{In-Stg1}}$  is the number of days since the individual entered stage 1 of illness [days],

$m$  is the slope [%/day], and

$b$  is the intercept [%].

## 5.2. BIOLOGICAL AGENT MODELS

### 5.2.1. Anthrax

1. Figure 5-3 summarizes the human response and casualty estimation processes for anthrax, Table 5-6 summarizes the Injury Profile, Table 5-8 summarizes the other anthrax submodels, and Table 5-7 summarizes the available anthrax prophylaxis options.
2. Assumptions and limitation.
  - a. Assumptions.
    - 1) The disease resulting from exposure to *B. anthracis* is inhalation anthrax.
    - 2) Untreated inhalation anthrax is 100% lethal.
  - b. Limitation. Although the model requires the user to specify a day on which antibiotic treatment becomes available ( $d_{\text{trt-anth}}$ ), it does *not* apply treatment to every person on that day; only those who have been declared WIA are modeled to begin receiving antibiotics on that day. Those who are declared WIA after  $d_{\text{trt-anth}}$  are modeled to begin receiving antibiotics on the day they are declared WIA.
3. Cohorts and special considerations.
  - a. The incubation period of anthrax is dose-dependent. Thus, the cohorts are separated according to dose range, and the PDTs contain unique probability distributions for each dose range. Table 5-4 summarizes the dose ranges. The E cohort is split into sub-cohorts labeled as  $E_{\text{DR}}$ , where DR is the dose range label given in Table 5-4. The population of each  $E_{\text{DR}}$  is calculated separately for each dose range by applying Equation 5-1 to icons within the appropriate range of doses.



**Table 5-4: Anthrax Dose Ranges**

Dose Range Label (DR)	Dose Range [spores]*
A	$X_{anth,n}^{eff} \leq 10^2$
B	$10^2 < X_{anth,n}^{eff} \leq 10^3$
C	$10^3 < X_{anth,n}^{eff} \leq 10^4$
D	$10^4 < X_{anth,n}^{eff} \leq 10^5$
E	$10^5 < X_{anth,n}^{eff} \leq 10^6$
F	$10^6 < X_{anth,n}^{eff} \leq 10^7$
G	$X_{anth,n}^{eff} > 10^7$

\* The values in the anthrax PDTs (Table 5-9 to Table 5-16) are calculated based on the upper dose for each dose range, with the exception of dose range G, which uses a dose of  $2 \times 10^7$  spores.

- b. If  $Flag_{MT} = \text{No}$ , the populations of the  $E_{DR}$  cohorts move to the  $F_{DR,U}$  cohorts as individuals DOW. No  $S_{DR,U}$  cohorts are used because the untreated lethality model is a 100% CFR (see Table 5-8).
- c. If  $Flag_{MT} = \text{Yes}$ , an individual's duration of illness and outcome depend upon the day on which antibiotic treatment becomes available. The user must specify the day on which antibiotic treatment becomes available for those declared WIA ( $d_{trt-anth}$ ). Based on  $d_{trt-anth}$  and the casualty criterion, the populations of the  $E_{DR}$  sub-cohorts are split among several sub-cohorts, as specified below.
  - 1) If the casualty criterion is WIA(1+) or WIA(2+), the  $E_{DR}$  sub-cohorts are split among the following list of sub-cohorts, according to Equations 5-35 to 5-39.
    - a)  $F_{DR,U}$  is the number of individuals in dose range DR who die before  $d_{trt-anth}$ .
    - b)  $F_{DR,T-2}$  is the number of individuals in dose range DR who are in Stage 2 on  $d_{trt-anth}$ , and will die despite antibiotic treatment.
    - c)  $F_{DR,T-1}$  is the number of individuals in dose range DR who are in Stage 1 on  $d_{trt-anth}$ , and will die despite antibiotic treatment.
    - d)  $S_{DR,T-1}$  is the number of individuals in dose range DR who are in Stage 1 on  $d_{trt-anth}$ , and will survive as a result of antibiotic treatment.

$$F_{DR,U} = E_{DR} \cdot \sum_{d=1}^{d_{trt-anth}} PDT_{5-11}(d) \quad (5-35)$$

$$F_{DR,T-2} = \left( E_{DR} \cdot \sum_{d=1}^{d_{trt-anth}} PDT_{5-10}(d) \right) - F_{DR,U} \quad (5-36)$$

$$F_{DR,T-1} = E_{DR} \cdot \left[ \sum_{d_{Stg1}=1}^{d_{trt-anth}} (p_{f,T-1} \cdot PDT_{5-9}(d_{Stg1}) \cdot P_{in-Stg1}) + 0.1 \cdot \left( 1 - \sum_{d=1}^{d_{trt-anth}} PDT_{5-9}(d) \right) \right] \quad (5-37)$$

$$S_{DR,T-1} = E_{DR} - F_{DR,U} - F_{DR,T-2} - F_{DR,T-1} \quad (5-38)$$

$$p_{f,T-1} = 0.012 \cdot (d_{trt-anth} - d_{Stg1}) + 0.1 \quad (5-39)$$

In Equations 5-35 to 5-39:

$d_{trt-anth}$  is the user-specified day on which treatment begins,

$d_{Stg1}$  is the day on which different fractions of  $E_{DR}$  enter Stage 1,

$(d_{trt-anth} - d_{Stg1})$  is the number of days between the onset of symptoms and the beginning of antibiotic treatment.

$PDT_{5-X}(d \text{ or } d_{Stg1})$  reflect fractions of a specific population that have entered a certain stage of disease, as a function of a chosen day ( $d$  or  $d_{Stg1}$ ), as dictated by Table 5-X,

$p_{f,T-1}$  is the probability of fatality for anthrax patients whose treatment is initiated in Stage 1,

$P_{in-Stg1}$  is the probability that an individual who entered Stage 1 of anthrax ( $d_{trt-anth} - d_{Stg1}$ ) days ago is still in Stage 1 (see Table 5-5).

- 2) If the casualty criterion is WIA(3<sup>+</sup>), the  $E_{DR}$  sub-cohorts are split among the  $F_{DR,U}$  and  $F_{DR,T-2}$  sub-cohorts, according to Equations 5-40 and 5-41

$$F_{DR,U} = E_{DR} \cdot \sum_{d=1}^{d_{trt-anth}} PDT_{5-11}(d) \quad (5-40)$$

$$F_{DR,T-2} = E_{DR} - F_{DR,U} \quad (5-41)$$

**Table 5-5: Probability of an Individual Still Being in Stage 1 of Anthrax ( $P_{in-Stg1}$ ) After Specified Durations Spent in Stage 1**

Days After Entering Stage 1 ( $d_{trt-anth} - d_{Stg1}$ )	Probability ( $P_{in-Stg1}$ )	Days After Entering Stage 1 ( $d_{trt-anth} - d_{Stg1}$ )	Probability ( $P_{in-Stg1}$ )	Days After Entering Stage 1 ( $d_{trt-anth} - d_{Stg1}$ )	Probability ( $P_{in-Stg1}$ )
0	1.0000	9	0.0407	18	0.0010
1	0.9946	10	0.0257	19	0.0007
2	0.8835	11	0.0164	20	0.0005
3	0.6558	12	0.0106	21	0.0004
4	0.4362	13	0.0069	22	0.0003
5	0.2755	14	0.0046	23	0.0002
6	0.1705	15	0.0031	24	0.0001
7	0.1051	16	0.0021	≥25	0.0000
8	0.0651	17	0.0014		

4. Table 5-9 through Table 5-16 are the PDTs for anthrax. The dose-bin specific values in a given table are to be used in Equations 5-5 through 5-8 with the cohort(s) listed in the table headers and footers, per Figure 5-3.

**Table 5-6: Anthrax Injury Profile**

Stage	Injury Severity Level
Untreated Non-Survivors ( $F_{DR,U}$ )	
1	2
2	4
Stage 1 Treated Survivors ( $S_{DR,T-1}$ )	
1	2
2	4
3	3
CONV	CONV
Stage 1 ( $F_{DR,T-1}$ ) and Stage 2 ( $F_{DR,T-2}$ ) Treated Non-Survivors	
1	2
2	4

**Table 5-7: Anthrax Prophylaxis Summary**

Type of Prophylaxis	Efficacy ( $\rho_n$ )
Pre-exposure vaccination	0.90
Pre-exposure vaccination plus post-exposure antibiotics	1.00
Post-exposure vaccination plus antibiotics	1.00

**Table 5-8: Anthrax Submodel Summary**

Type	Value		
<b>Infectivity (<math>p_E(X_{anth,n}^{eff})</math>)</b>			
Lognormal Distribution	Use Equation 5-32 ID <sub>50</sub> = 20,000 spores Probit slope = 1 probit/log(dose)		
<b>Lethality (<math>p_f(anth)</math>)</b>			
Untreated OR Treatment Initiated in Stage 2			
CFR	100%		
Treatment Initiated in Stage 1			
Linear Function	Use Equation 5-34 m = 1.2 %/day since entering Stage 1 b = 10 %		
<b>Incubation Period*</b>			
Dose-Dependent Lognormal Distribution	Dose Range Label	Mean (days)	Standard Deviation (days)
	A	9.36	6.74
	B	7.34	4.52
	C	5.52	2.86
	D	3.86	1.65
	E	2.32	0.79
	F	0.88	0.22
G	0.46	0.10	
<b>Duration of Illness*</b>			
Stage 1: Untreated ( $F_{DR,U}$ )			
Stage 1: Treatment Initiated in Stage 2 ( $F_{DR,T-2}$ )			
Lognormal Distribution	Mean = 4.2 days Standard deviation = 2.3 days		
Stage 2: Untreated ( $F_{DR,U}$ )			
Lognormal Distribution	Mean = 0.70 days Standard deviation = 0.74 days		
Stage 1: Treatment Initiated in Stage 1 ( $S_{DR,T-1}$ and $F_{DR,T-1}$ )			
Lognormal Distribution	Mean = 5.8 days Standard deviation = 2.0 days		
Stage 2: Treatment Initiated in Stage 1 ( $S_{DR,T-1}$ and $F_{DR,T-1}$ )			
Lognormal Distribution	Mean = 1.4 days Standard deviation = 1.8 days		
Stage 3: Treatment Initiated in Stage 1 ( $S_{DR,T-1}$ )			
Constant	11 days		
CONV: Treatment Initiated in Stage 1 ( $S_{DR,T-1}$ )			
Constant	60 days		
Stage 2: Treatment Initiated in Stage 2 ( $F_{DR,T-2}$ )			
Lognormal Distribution	Mean = 1.5 days Standard deviation = 1.3 days		

\* Presented for information only. These two submodels have already been convolved to generate the PDTs; the user should use the PDTs to estimate when changes in casualty category occur.

**Table 5-9: Daily Fraction of Individuals Ill with Anthrax (E<sub>DR</sub>) Who Become WIA, for Casualty Criterion WIA(1+) or WIA(2+)\***

Day	Dose Range						
	A	B	C	D	E	F	G
1	0.0008	0.0006	0.0006	0.0010	0.0084	0.7413	0.9998
2	0.0185	0.0216	0.0326	0.0793	0.3779	0.2583	0.0002
3	0.0557	0.0755	0.1242	0.2600	0.4400	0.0004	0.0000
4	0.0851	0.1179	0.1814	0.2745	0.1386	0.0000	0.0000
5	0.0982	0.1313	0.1778	0.1840	0.0286	0.0000	0.0000
6	0.0988	0.1243	0.1444	0.1015	0.0052	0.0000	0.0000
7	0.0921	0.1079	0.1066	0.0513	0.0010	0.0000	0.0000
8	0.0823	0.0891	0.0749	0.0250	0.0003	0.0000	0.0000
9	0.0716	0.0716	0.0512	0.0120	0.0000	0.0000	0.0000
10	0.0613	0.0565	0.0345	0.0058	0.0000	0.0000	0.0000
11	0.0519	0.0442	0.0231	0.0028	0.0000	0.0000	0.0000
12	0.0438	0.0344	0.0155	0.0014	0.0000	0.0000	0.0000
13	0.0368	0.0267	0.0104	0.0007	0.0000	0.0000	0.0000
14	0.0308	0.0208	0.0071	0.0004	0.0000	0.0000	0.0000
15	0.0259	0.0162	0.0048	0.0002	0.0000	0.0000	0.0000
16	0.0217	0.0126	0.0033	0.0001	0.0000	0.0000	0.0000
17	0.0182	0.0099	0.0023	0.0000	0.0000	0.0000	0.0000
18	0.0154	0.0078	0.0016	0.0000	0.0000	0.0000	0.0000
19	0.0129	0.0061	0.0011	0.0000	0.0000	0.0000	0.0000
20	0.0109	0.0048	0.0008	0.0000	0.0000	0.0000	0.0000
21	0.0093	0.0038	0.0005	0.0000	0.0000	0.0000	0.0000
22	0.0079	0.0031	0.0004	0.0000	0.0000	0.0000	0.0000
23	0.0067	0.0024	0.0003	0.0000	0.0000	0.0000	0.0000
24	0.0057	0.0020	0.0002	0.0000	0.0000	0.0000	0.0000
25	0.0049	0.0016	0.0001	0.0000	0.0000	0.0000	0.0000
26	0.0042	0.0013	0.0001	0.0000	0.0000	0.0000	0.0000
27	0.0036	0.0010	0.0001	0.0000	0.0000	0.0000	0.0000
28	0.0031	0.0008	0.0001	0.0000	0.0000	0.0000	0.0000
29	0.0027	0.0007	0.0000	0.0000	0.0000	0.0000	0.0000
30	0.0023	0.0006	0.0000	0.0000	0.0000	0.0000	0.0000
31	0.0020	0.0005	0.0000	0.0000	0.0000	0.0000	0.0000
32	0.0017	0.0004	0.0000	0.0000	0.0000	0.0000	0.0000
33	0.0015	0.0003	0.0000	0.0000	0.0000	0.0000	0.0000
34	0.0013	0.0003	0.0000	0.0000	0.0000	0.0000	0.0000
35	0.0012	0.0002	0.0000	0.0000	0.0000	0.0000	0.0000
36	0.0010	0.0002	0.0000	0.0000	0.0000	0.0000	0.0000
37	0.0009	0.0002	0.0000	0.0000	0.0000	0.0000	0.0000
38	0.0008	0.0001	0.0000	0.0000	0.0000	0.0000	0.0000
39	0.0007	0.0001	0.0000	0.0000	0.0000	0.0000	0.0000
40	0.0006	0.0001	0.0000	0.0000	0.0000	0.0000	0.0000
41	0.0005	0.0001	0.0000	0.0000	0.0000	0.0000	0.0000
42	0.0005	0.0001	0.0000	0.0000	0.0000	0.0000	0.0000
43	0.0004	0.0001	0.0000	0.0000	0.0000	0.0000	0.0000
44	0.0004	0.0001	0.0000	0.0000	0.0000	0.0000	0.0000
45	0.0003	0.0001	0.0000	0.0000	0.0000	0.0000	0.0000
46	0.0003	0.0000	0.0000	0.0000	0.0000	0.0000	0.0000
47	0.0003	0.0000	0.0000	0.0000	0.0000	0.0000	0.0000
48-51	0.0002	0.0000	0.0000	0.0000	0.0000	0.0000	0.0000
52-68	0.0001	0.0000	0.0000	0.0000	0.0000	0.0000	0.0000
≥69	0.0000	0.0000	0.0000	0.0000	0.0000	0.0000	0.0000

\* This equates to the time at which all cohorts enter Stage 1 (Severity Level 2).

**Table 5-10: Daily Fraction of Individuals Ill with Anthrax ( $E_{DR}$ ) Who Become WIA, for Casualty Criterion WIA(3+)\***

Day	Dose Range						
	A	B	C	D	E	F	G
1	0.0000	0.0000	0.0000	0.0000	0.0000	0.0000	0.0002
2	0.0000	0.0000	0.0000	0.0000	0.0002	0.0132	0.0451
3	0.0007	0.0007	0.0010	0.0023	0.0134	0.1296	0.1889
4	0.0055	0.0066	0.0102	0.0236	0.0872	0.2290	0.2346
5	0.0179	0.0234	0.0373	0.0774	0.1803	0.2127	0.1893
6	0.0363	0.0489	0.0762	0.1358	0.2068	0.1537	0.1289
7	0.0554	0.0746	0.1101	0.1645	0.1738	0.0999	0.0817
8	0.0705	0.0929	0.1273	0.1585	0.1238	0.0621	0.0503
9	0.0794	0.1012	0.1272	0.1317	0.0810	0.0380	0.0307
10	0.0823	0.1005	0.1148	0.0994	0.0508	0.0232	0.0188
11	0.0805	0.0934	0.0966	0.0703	0.0313	0.0142	0.0115
12	0.0754	0.0829	0.0773	0.0477	0.0192	0.0088	0.0072
13	0.0686	0.0711	0.0596	0.0315	0.0118	0.0055	0.0045
14	0.0610	0.0594	0.0448	0.0204	0.0073	0.0035	0.0029
15	0.0534	0.0488	0.0330	0.0131	0.0046	0.0022	0.0018
16	0.0462	0.0396	0.0240	0.0084	0.0029	0.0014	0.0012
17	0.0396	0.0318	0.0173	0.0054	0.0019	0.0009	0.0008
18	0.0338	0.0254	0.0124	0.0034	0.0012	0.0006	0.0005
19	0.0287	0.0202	0.0088	0.0022	0.0008	0.0004	0.0004
20	0.0243	0.0160	0.0063	0.0014	0.0005	0.0003	0.0002
21	0.0206	0.0127	0.0045	0.0009	0.0004	0.0002	0.0002
22	0.0174	0.0100	0.0032	0.0006	0.0002	0.0001	0.0001
23	0.0147	0.0079	0.0023	0.0004	0.0002	0.0001	0.0001
24	0.0125	0.0063	0.0016	0.0003	0.0001	0.0001	0.0001
25	0.0106	0.0050	0.0012	0.0002	0.0001	0.0001	0.0000
26	0.0090	0.0040	0.0008	0.0001	0.0001	0.0001	0.0000
27	0.0076	0.0032	0.0006	0.0001	0.0001	0.0001	0.0000
28	0.0065	0.0025	0.0004	0.0001	0.0000	0.0000	0.0000
29	0.0055	0.0020	0.0003	0.0001	0.0000	0.0000	0.0000
30	0.0047	0.0016	0.0002	0.0001	0.0000	0.0000	0.0000
31	0.0041	0.0013	0.0002	0.0001	0.0000	0.0000	0.0000
32	0.0035	0.0011	0.0001	0.0000	0.0000	0.0000	0.0000
33	0.0030	0.0009	0.0001	0.0000	0.0000	0.0000	0.0000
34	0.0026	0.0007	0.0001	0.0000	0.0000	0.0000	0.0000
35	0.0022	0.0006	0.0001	0.0000	0.0000	0.0000	0.0000
36	0.0019	0.0005	0.0001	0.0000	0.0000	0.0000	0.0000
37	0.0017	0.0004	0.0000	0.0000	0.0000	0.0000	0.0000
38	0.0015	0.0003	0.0000	0.0000	0.0000	0.0000	0.0000
39	0.0013	0.0003	0.0000	0.0000	0.0000	0.0000	0.0000
40	0.0011	0.0002	0.0000	0.0000	0.0000	0.0000	0.0000
41	0.0010	0.0002	0.0000	0.0000	0.0000	0.0000	0.0000
42	0.0009	0.0002	0.0000	0.0000	0.0000	0.0000	0.0000
43	0.0008	0.0001	0.0000	0.0000	0.0000	0.0000	0.0000
44	0.0007	0.0001	0.0000	0.0000	0.0000	0.0000	0.0000
45	0.0006	0.0001	0.0000	0.0000	0.0000	0.0000	0.0000
46	0.0005	0.0001	0.0000	0.0000	0.0000	0.0000	0.0000
47	0.0005	0.0001	0.0000	0.0000	0.0000	0.0000	0.0000
48	0.0004	0.0001	0.0000	0.0000	0.0000	0.0000	0.0000
49	0.0004	0.0001	0.0000	0.0000	0.0000	0.0000	0.0000

Day	Dose Range						
	A	B	C	D	E	F	G
50-52	0.0003	0.0000	0.0000	0.0000	0.0000	0.0000	0.0000
53-56	0.0002	0.0000	0.0000	0.0000	0.0000	0.0000	0.0000
57-66	0.0001	0.0000	0.0000	0.0000	0.0000	0.0000	0.0000
≥67	0.0000	0.0000	0.0000	0.0000	0.0000	0.0000	0.0000

\* When the casualty criterion is WIA(3+), this equates to the time at which all casualties enter Stage 2 (Severity Level 4). When the casualty criterion is WIA(1+) or WIA(2+), this equates to the time at which the F<sub>DR,U</sub> and F<sub>DR,T-2</sub> cohorts enter Stage 2 (Severity Level 4).

**Table 5-11: Daily Fraction of Untreated Anthrax Non-Survivors (F<sub>DR,U</sub>) Who DOW**

Day	Dose Range						
	A	B	C	D	E	F	G
1	0.0000	0.0000	0.0000	0.0000	0.0000	0.0000	0.0000
2	0.0000	0.0000	0.0000	0.0000	0.0000	0.0022	0.0111
3	0.0002	0.0002	0.0002	0.0005	0.0034	0.0560	0.1048
4	0.0023	0.0026	0.0039	0.0092	0.0399	0.1701	0.2030
5	0.0099	0.0126	0.0199	0.0434	0.1233	0.2148	0.2091
6	0.0244	0.0325	0.0513	0.0985	0.1863	0.1851	0.1638
7	0.0427	0.0575	0.0874	0.1438	0.1890	0.1335	0.1127
8	0.0599	0.0799	0.1143	0.1589	0.1530	0.0884	0.0729
9	0.0726	0.0944	0.1252	0.1465	0.1089	0.0561	0.0458
10	0.0795	0.0997	0.1213	0.1195	0.0722	0.0350	0.0285
11	0.0809	0.0971	0.1077	0.0898	0.0461	0.0217	0.0177
12	0.0783	0.0893	0.0899	0.0637	0.0289	0.0135	0.0110
13	0.0729	0.0788	0.0717	0.0435	0.0180	0.0084	0.0069
14	0.0660	0.0673	0.0553	0.0289	0.0112	0.0053	0.0044
15	0.0586	0.0562	0.0416	0.0189	0.0070	0.0034	0.0028
16	0.0512	0.0462	0.0307	0.0123	0.0045	0.0022	0.0018
17	0.0442	0.0374	0.0224	0.0079	0.0028	0.0014	0.0012
18	0.0379	0.0301	0.0162	0.0051	0.0018	0.0009	0.0008
19	0.0324	0.0240	0.0116	0.0033	0.0012	0.0006	0.0005
20	0.0275	0.0191	0.0083	0.0021	0.0008	0.0004	0.0004
21	0.0233	0.0152	0.0059	0.0014	0.0005	0.0003	0.0002
22	0.0197	0.0120	0.0042	0.0009	0.0004	0.0002	0.0002
23	0.0167	0.0095	0.0030	0.0006	0.0002	0.0001	0.0001
24	0.0141	0.0076	0.0022	0.0004	0.0002	0.0001	0.0001
25	0.0120	0.0060	0.0015	0.0003	0.0001	0.0001	0.0001
26	0.0102	0.0048	0.0011	0.0002	0.0001	0.0001	0.0001
27	0.0086	0.0038	0.0008	0.0001	0.0001	0.0001	0.0000
28	0.0073	0.0030	0.0006	0.0001	0.0001	0.0000	0.0000
29	0.0063	0.0024	0.0004	0.0001	0.0000	0.0000	0.0000
30	0.0053	0.0019	0.0003	0.0001	0.0000	0.0000	0.0000
31	0.0046	0.0016	0.0002	0.0000	0.0000	0.0000	0.0000
32	0.0039	0.0013	0.0002	0.0000	0.0000	0.0000	0.0000
33	0.0034	0.0010	0.0001	0.0000	0.0000	0.0000	0.0000
34	0.0029	0.0008	0.0001	0.0000	0.0000	0.0000	0.0000
35	0.0025	0.0007	0.0001	0.0000	0.0000	0.0000	0.0000
36	0.0022	0.0006	0.0001	0.0000	0.0000	0.0000	0.0000
37	0.0019	0.0005	0.0001	0.0000	0.0000	0.0000	0.0000
38	0.0016	0.0004	0.0001	0.0000	0.0000	0.0000	0.0000

Day	Dose Range						
	A	B	C	D	E	F	G
39	0.0014	0.0003	0.0001	0.0000	0.0000	0.0000	0.0000
40	0.0012	0.0003	0.0000	0.0000	0.0000	0.0000	0.0000
41	0.0011	0.0002	0.0000	0.0000	0.0000	0.0000	0.0000
42	0.0009	0.0002	0.0000	0.0000	0.0000	0.0000	0.0000
43	0.0008	0.0001	0.0000	0.0000	0.0000	0.0000	0.0000
44	0.0007	0.0001	0.0000	0.0000	0.0000	0.0000	0.0000
45	0.0006	0.0001	0.0000	0.0000	0.0000	0.0000	0.0000
46	0.0006	0.0001	0.0000	0.0000	0.0000	0.0000	0.0000
47	0.0005	0.0001	0.0000	0.0000	0.0000	0.0000	0.0000
48	0.0004	0.0001	0.0000	0.0000	0.0000	0.0000	0.0000
49	0.0004	0.0001	0.0000	0.0000	0.0000	0.0000	0.0000
50	0.0003	0.0001	0.0000	0.0000	0.0000	0.0000	0.0000
51	0.0003	0.0001	0.0000	0.0000	0.0000	0.0000	0.0000
52	0.0003	0.0000	0.0000	0.0000	0.0000	0.0000	0.0000
53-57	0.0002	0.0000	0.0000	0.0000	0.0000	0.0000	0.0000
58-73	0.0001	0.0000	0.0000	0.0000	0.0000	0.0000	0.0000
≥74	0.0000	0.0000	0.0000	0.0000	0.0000	0.0000	0.0000

**Table 5-12: Daily Fraction of Stage 1 Treated Anthrax Non-Survivors ( $F_{DR,T-1}$ ) and Survivors ( $S_{DR,T-1}$ ) Who Enter Stage 2**

Day	Dose Range						
	A	B	C	D	E	F	G
1	0.0000	0.0000	0.0000	0.0000	0.0000	0.0000	0.0000
2	0.0000	0.0000	0.0000	0.0000	0.0000	0.0000	0.0001
3	0.0000	0.0000	0.0000	0.0000	0.0001	0.0031	0.0112
4	0.0002	0.0002	0.0000	0.0006	0.0035	0.0459	0.0852
5	0.0020	0.0023	0.0007	0.0080	0.0335	0.1495	0.1903
6	0.0086	0.0109	0.0053	0.0374	0.1088	0.2197	0.2252
7	0.0223	0.0295	0.0196	0.0905	0.1831	0.2084	0.1881
8	0.0410	0.0551	0.0455	0.1423	0.2032	0.1537	0.1286
9	0.0597	0.0798	0.0766	0.1665	0.1722	0.0977	0.0780
10	0.0742	0.0970	0.1030	0.1586	0.1220	0.0567	0.0440
11	0.0823	0.1040	0.1175	0.1303	0.0768	0.0311	0.0237
12	0.0842	0.1019	0.1186	0.0962	0.0447	0.0165	0.0125
13	0.0813	0.0934	0.1094	0.0656	0.0247	0.0086	0.0064
14	0.0753	0.0816	0.0942	0.0421	0.0132	0.0044	0.0033
15	0.0676	0.0689	0.0770	0.0259	0.0069	0.0023	0.0017
16	0.0594	0.0566	0.0605	0.0154	0.0036	0.0012	0.0009
17	0.0514	0.0457	0.0461	0.0090	0.0018	0.0006	0.0004
18	0.0440	0.0365	0.0344	0.0051	0.0009	0.0003	0.0002
19	0.0374	0.0289	0.0253	0.0029	0.0005	0.0002	0.0001
20	0.0316	0.0227	0.0184	0.0016	0.0003	0.0001	0.0001
21	0.0267	0.0178	0.0133	0.0009	0.0001	0.0000	0.0000
22	0.0225	0.0140	0.0096	0.0005	0.0001	0.0000	0.0000
23	0.0189	0.0110	0.0068	0.0003	0.0000	0.0000	0.0000
24	0.0160	0.0086	0.0049	0.0002	0.0000	0.0000	0.0000
25	0.0135	0.0068	0.0035	0.0001	0.0000	0.0000	0.0000
26	0.0114	0.0053	0.0026	0.0000	0.0000	0.0000	0.0000
27	0.0096	0.0042	0.0019	0.0000	0.0000	0.0000	0.0000
28	0.0082	0.0034	0.0014	0.0000	0.0000	0.0000	0.0000



Day	Dose Range						
	A	B	C	D	E	F	G
29	0.0069	0.0027	0.0010	0.0000	0.0000	0.0000	0.0000
30	0.0059	0.0021	0.0007	0.0000	0.0000	0.0000	0.0000
31	0.0050	0.0017	0.0006	0.0000	0.0000	0.0000	0.0000
32	0.0043	0.0014	0.0004	0.0000	0.0000	0.0000	0.0000
33	0.0037	0.0011	0.0003	0.0000	0.0000	0.0000	0.0000
34	0.0032	0.0009	0.0002	0.0000	0.0000	0.0000	0.0000
35	0.0027	0.0007	0.0002	0.0000	0.0000	0.0000	0.0000
36	0.0024	0.0006	0.0001	0.0000	0.0000	0.0000	0.0000
37	0.0021	0.0005	0.0001	0.0000	0.0000	0.0000	0.0000
38	0.0018	0.0004	0.0001	0.0000	0.0000	0.0000	0.0000
39	0.0015	0.0003	0.0001	0.0000	0.0000	0.0000	0.0000
40	0.0013	0.0003	0.0001	0.0000	0.0000	0.0000	0.0000
41	0.0012	0.0002	0.0000	0.0000	0.0000	0.0000	0.0000
42	0.0010	0.0002	0.0000	0.0000	0.0000	0.0000	0.0000
43	0.0009	0.0002	0.0000	0.0000	0.0000	0.0000	0.0000
44	0.0008	0.0001	0.0000	0.0000	0.0000	0.0000	0.0000
45	0.0007	0.0001	0.0000	0.0000	0.0000	0.0000	0.0000
46	0.0006	0.0001	0.0000	0.0000	0.0000	0.0000	0.0000
47	0.0005	0.0001	0.0000	0.0000	0.0000	0.0000	0.0000
48	0.0005	0.0001	0.0000	0.0000	0.0000	0.0000	0.0000
49	0.0004	0.0001	0.0000	0.0000	0.0000	0.0000	0.0000
50	0.0004	0.0000	0.0000	0.0000	0.0000	0.0000	0.0000
51-53	0.0003	0.0000	0.0000	0.0000	0.0000	0.0000	0.0000
54-58	0.0002	0.0000	0.0000	0.0000	0.0000	0.0000	0.0000
59-68	0.0001	0.0000	0.0000	0.0000	0.0000	0.0000	0.0000
≥69	0.0000	0.0000	0.0000	0.0000	0.0000	0.0000	0.0000

**Table 5-13: Daily Fraction of Stage 1 Treated Anthrax Non-Survivors ( $F_{DR,T-1}$ ) Who DOW\***

Day	Dose Range						
	A	B	C	D	E	F	G
≤2	0.0000	0.0000	0.0000	0.0000	0.0000	0.0000	0.0000
3	0.0000	0.0000	0.0000	0.0000	0.0000	0.0003	0.0014
4	0.0000	0.0000	0.0000	0.0001	0.0005	0.0099	0.0234
5	0.0005	0.0005	0.0007	0.0017	0.0082	0.0584	0.0903
6	0.0028	0.0034	0.0053	0.0120	0.0420	0.1348	0.1618
7	0.0096	0.0124	0.0196	0.0407	0.1031	0.1821	0.1873
8	0.0219	0.0291	0.0454	0.0845	0.1567	0.1790	0.1672
9	0.0380	0.0509	0.0766	0.1251	0.1737	0.1448	0.1273
10	0.0543	0.0721	0.1030	0.1460	0.1557	0.1038	0.0878
11	0.0675	0.0878	0.1175	0.1435	0.1209	0.0690	0.0570
12	0.0758	0.0956	0.1186	0.1243	0.0852	0.0438	0.0357
13	0.0791	0.0958	0.1094	0.0982	0.0564	0.0272	0.0221
14	0.0780	0.0903	0.0941	0.0724	0.0359	0.0167	0.0136
15	0.0737	0.0811	0.0769	0.0508	0.0224	0.0103	0.0084
16	0.0676	0.0704	0.0604	0.0344	0.0138	0.0065	0.0053
17	0.0605	0.0594	0.0461	0.0227	0.0086	0.0041	0.0034
18	0.0532	0.0492	0.0344	0.0148	0.0054	0.0027	0.0022
19	0.0462	0.0402	0.0253	0.0096	0.0035	0.0018	0.0015
20	0.0398	0.0324	0.0184	0.0062	0.0023	0.0012	0.0010

Day	Dose Range						
	A	B	C	D	E	F	G
21	0.0340	0.0260	0.0133	0.0040	0.0015	0.0009	0.0007
22	0.0290	0.0207	0.0095	0.0026	0.0010	0.0006	0.0005
23	0.0246	0.0165	0.0068	0.0018	0.0007	0.0004	0.0004
24	0.0209	0.0131	0.0049	0.0012	0.0005	0.0003	0.0003
25	0.0177	0.0104	0.0035	0.0008	0.0004	0.0003	0.0002
26	0.0150	0.0083	0.0026	0.0006	0.0003	0.0002	0.0002
27	0.0127	0.0066	0.0019	0.0004	0.0002	0.0002	0.0002
28	0.0108	0.0053	0.0014	0.0003	0.0002	0.0001	0.0002
29	0.0092	0.0042	0.0010	0.0002	0.0001	0.0001	0.0001
30	0.0078	0.0034	0.0007	0.0002	0.0001	0.0001	0.0001
31	0.0067	0.0027	0.0006	0.0001	0.0001	0.0001	0.0001
32	0.0057	0.0022	0.0004	0.0001	0.0001	0.0001	0.0001
33	0.0049	0.0018	0.0003	0.0001	0.0001	0.0001	0.0001
34	0.0042	0.0014	0.0002	0.0001	0.0001	0.0001	0.0001
35	0.0036	0.0012	0.0002	0.0001	0.0001	0.0000	0.0000
36	0.0031	0.0010	0.0001	0.0001	0.0001	0.0000	0.0000
37	0.0027	0.0008	0.0001	0.0001	0.0001	0.0000	0.0000
38	0.0023	0.0006	0.0001	0.0001	0.0000	0.0000	0.0000
39	0.0020	0.0005	0.0001	0.0001	0.0000	0.0000	0.0000
40	0.0017	0.0004	0.0001	0.0000	0.0000	0.0000	0.0000
41	0.0015	0.0004	0.0001	0.0000	0.0000	0.0000	0.0000
42	0.0013	0.0003	0.0001	0.0000	0.0000	0.0000	0.0000
43	0.0012	0.0003	0.0001	0.0000	0.0000	0.0000	0.0000
44	0.0010	0.0002	0.0001	0.0000	0.0000	0.0000	0.0000
45	0.0009	0.0002	0.0001	0.0000	0.0000	0.0000	0.0000
46	0.0008	0.0001	0.0000	0.0000	0.0000	0.0000	0.0000
47	0.0007	0.0001	0.0000	0.0000	0.0000	0.0000	0.0000
48	0.0006	0.0001	0.0000	0.0000	0.0000	0.0000	0.0000
49	0.0005	0.0001	0.0000	0.0000	0.0000	0.0000	0.0000
50	0.0005	0.0001	0.0000	0.0000	0.0000	0.0000	0.0000
51	0.0004	0.0001	0.0000	0.0000	0.0000	0.0000	0.0000
52	0.0004	0.0001	0.0000	0.0000	0.0000	0.0000	0.0000
53	0.0003	0.0001	0.0000	0.0000	0.0000	0.0000	0.0000
54	0.0003	0.0001	0.0000	0.0000	0.0000	0.0000	0.0000
55	0.0003	0.0000	0.0000	0.0000	0.0000	0.0000	0.0000
56-59	0.0002	0.0000	0.0000	0.0000	0.0000	0.0000	0.0000
60-73	0.0001	0.0000	0.0000	0.0000	0.0000	0.0000	0.0000
≥74	0.0000	0.0000	0.0000	0.0000	0.0000	0.0000	0.0000

\* This equates to the time at which the  $S_{DR,T-1}$  enter Stage 3 (Severity Level 3).

**Table 5-14: Daily Fraction of Stage 1 Treated Anthrax Survivors ( $S_{DR,T-1}$ ) Who Become CONV\***

Day	Dose Range						
	A	B	C	D	E	F	G
≤13	0.0000	0.0000	0.0000	0.0000	0.0000	0.0000	0.0000
14	0.0000	0.0000	0.0000	0.0000	0.0000	0.0003	0.0014
15	0.0000	0.0000	0.0000	0.0001	0.0005	0.0099	0.0234
16	0.0005	0.0005	0.0007	0.0017	0.0082	0.0584	0.0903
17	0.0028	0.0034	0.0053	0.0120	0.0420	0.1348	0.1618
18	0.0096	0.0124	0.0196	0.0407	0.1031	0.1821	0.1873
19	0.0219	0.0291	0.0454	0.0845	0.1567	0.1790	0.1672
20	0.0380	0.0509	0.0766	0.1251	0.1737	0.1448	0.1273
21	0.0543	0.0721	0.1030	0.1460	0.1557	0.1038	0.0878
22	0.0675	0.0878	0.1175	0.1435	0.1209	0.0690	0.0570
23	0.0758	0.0956	0.1186	0.1243	0.0852	0.0438	0.0357
24	0.0791	0.0958	0.1094	0.0982	0.0564	0.0272	0.0221
25	0.0780	0.0903	0.0941	0.0724	0.0359	0.0167	0.0136
26	0.0737	0.0811	0.0769	0.0508	0.0224	0.0103	0.0084
27	0.0676	0.0704	0.0604	0.0344	0.0138	0.0065	0.0053
28	0.0605	0.0594	0.0461	0.0227	0.0086	0.0041	0.0034
29	0.0532	0.0492	0.0344	0.0148	0.0054	0.0027	0.0022
30	0.0462	0.0402	0.0253	0.0096	0.0035	0.0018	0.0015
31	0.0398	0.0324	0.0184	0.0062	0.0023	0.0012	0.0010
32	0.0340	0.0260	0.0133	0.0040	0.0015	0.0009	0.0007
33	0.0290	0.0207	0.0095	0.0026	0.0010	0.0006	0.0005
34	0.0246	0.0165	0.0068	0.0018	0.0007	0.0004	0.0004
35	0.0209	0.0131	0.0049	0.0012	0.0005	0.0003	0.0003
36	0.0177	0.0104	0.0035	0.0008	0.0004	0.0003	0.0002
37	0.0150	0.0083	0.0026	0.0006	0.0003	0.0002	0.0002
38	0.0127	0.0066	0.0019	0.0004	0.0002	0.0002	0.0002
39	0.0108	0.0053	0.0014	0.0003	0.0002	0.0001	0.0002
40	0.0092	0.0042	0.0010	0.0002	0.0001	0.0001	0.0001
41	0.0078	0.0034	0.0007	0.0002	0.0001	0.0001	0.0001
42	0.0067	0.0027	0.0006	0.0001	0.0001	0.0001	0.0001
43	0.0057	0.0022	0.0004	0.0001	0.0001	0.0001	0.0001
44	0.0049	0.0018	0.0003	0.0001	0.0001	0.0001	0.0001
45	0.0042	0.0014	0.0002	0.0001	0.0001	0.0001	0.0001
46	0.0036	0.0012	0.0002	0.0001	0.0001	0.0000	0.0000
47	0.0031	0.0010	0.0001	0.0001	0.0001	0.0000	0.0000
48	0.0027	0.0008	0.0001	0.0001	0.0001	0.0000	0.0000
49	0.0023	0.0006	0.0001	0.0001	0.0000	0.0000	0.0000
50	0.0020	0.0005	0.0001	0.0001	0.0000	0.0000	0.0000
51	0.0017	0.0004	0.0001	0.0000	0.0000	0.0000	0.0000
52	0.0015	0.0004	0.0001	0.0000	0.0000	0.0000	0.0000
53	0.0013	0.0003	0.0001	0.0000	0.0000	0.0000	0.0000
54	0.0012	0.0003	0.0001	0.0000	0.0000	0.0000	0.0000
55	0.0010	0.0002	0.0001	0.0000	0.0000	0.0000	0.0000
56	0.0009	0.0002	0.0001	0.0000	0.0000	0.0000	0.0000
57	0.0008	0.0001	0.0000	0.0000	0.0000	0.0000	0.0000
58	0.0007	0.0001	0.0000	0.0000	0.0000	0.0000	0.0000
59	0.0006	0.0001	0.0000	0.0000	0.0000	0.0000	0.0000
60	0.0005	0.0001	0.0000	0.0000	0.0000	0.0000	0.0000
61	0.0005	0.0001	0.0000	0.0000	0.0000	0.0000	0.0000

Day	Dose Range						
	A	B	C	D	E	F	G
62	0.0004	0.0001	0.0000	0.0000	0.0000	0.0000	0.0000
63	0.0004	0.0001	0.0000	0.0000	0.0000	0.0000	0.0000
64	0.0003	0.0001	0.0000	0.0000	0.0000	0.0000	0.0000
65	0.0003	0.0001	0.0000	0.0000	0.0000	0.0000	0.0000
66	0.0003	0.0000	0.0000	0.0000	0.0000	0.0000	0.0000
67-70	0.0002	0.0000	0.0000	0.0000	0.0000	0.0000	0.0000
71-84	0.0001	0.0000	0.0000	0.0000	0.0000	0.0000	0.0000
≥85	0.0000	0.0000	0.0000	0.0000	0.0000	0.0000	0.0000

\* This equates to the time at which the  $S_{DR,T-1}$  enter Stage 4 (Severity Level 2).

**Table 5-15: Daily Fraction of Stage 1 Treated Anthrax Survivors ( $S_{DR,T-1}$ ) Who Become RTD**

Day	Dose Range						
	A	B	C	D	E	F	G
≤73	0.0000	0.0000	0.0000	0.0000	0.0000	0.0000	0.0000
74	0.0000	0.0000	0.0000	0.0000	0.0000	0.0003	0.0014
75	0.0000	0.0000	0.0000	0.0001	0.0005	0.0099	0.0234
76	0.0005	0.0005	0.0007	0.0017	0.0082	0.0584	0.0903
77	0.0028	0.0034	0.0053	0.0120	0.0420	0.1348	0.1618
78	0.0096	0.0124	0.0196	0.0407	0.1031	0.1821	0.1873
79	0.0219	0.0291	0.0454	0.0845	0.1567	0.1790	0.1672
80	0.0380	0.0509	0.0766	0.1251	0.1737	0.1448	0.1273
81	0.0543	0.0721	0.1030	0.1460	0.1557	0.1038	0.0878
82	0.0675	0.0878	0.1175	0.1435	0.1209	0.0690	0.0570
83	0.0758	0.0956	0.1186	0.1243	0.0852	0.0438	0.0357
84	0.0791	0.0958	0.1094	0.0982	0.0564	0.0272	0.0221
85	0.0780	0.0903	0.0941	0.0724	0.0359	0.0167	0.0136
86	0.0737	0.0811	0.0769	0.0508	0.0224	0.0103	0.0084
87	0.0676	0.0704	0.0604	0.0344	0.0138	0.0065	0.0053
88	0.0605	0.0594	0.0461	0.0227	0.0086	0.0041	0.0034
89	0.0532	0.0492	0.0344	0.0148	0.0054	0.0027	0.0022
90	0.0462	0.0402	0.0253	0.0096	0.0035	0.0018	0.0015
91	0.0398	0.0324	0.0184	0.0062	0.0023	0.0012	0.0010
92	0.0340	0.0260	0.0133	0.0040	0.0015	0.0009	0.0007
93	0.0290	0.0207	0.0095	0.0026	0.0010	0.0006	0.0005
94	0.0246	0.0165	0.0068	0.0018	0.0007	0.0004	0.0004
95	0.0209	0.0131	0.0049	0.0012	0.0005	0.0003	0.0003
96	0.0177	0.0104	0.0035	0.0008	0.0004	0.0003	0.0002
97	0.0150	0.0083	0.0026	0.0006	0.0003	0.0002	0.0002
98	0.0127	0.0066	0.0019	0.0004	0.0002	0.0002	0.0002
99	0.0108	0.0053	0.0014	0.0003	0.0002	0.0001	0.0002
100	0.0092	0.0042	0.0010	0.0002	0.0001	0.0001	0.0001
101	0.0078	0.0034	0.0007	0.0002	0.0001	0.0001	0.0001
102	0.0067	0.0027	0.0006	0.0001	0.0001	0.0001	0.0001
103	0.0057	0.0022	0.0004	0.0001	0.0001	0.0001	0.0001
104	0.0049	0.0018	0.0003	0.0001	0.0001	0.0001	0.0001
105	0.0042	0.0014	0.0002	0.0001	0.0001	0.0001	0.0001
106	0.0036	0.0012	0.0002	0.0001	0.0001	0.0000	0.0000
107	0.0031	0.0010	0.0001	0.0001	0.0001	0.0000	0.0000
108	0.0027	0.0008	0.0001	0.0001	0.0001	0.0000	0.0000

Day	Dose Range						
	A	B	C	D	E	F	G
109	0.0023	0.0006	0.0001	0.0001	0.0000	0.0000	0.0000
110	0.0020	0.0005	0.0001	0.0001	0.0000	0.0000	0.0000
111	0.0017	0.0004	0.0001	0.0000	0.0000	0.0000	0.0000
112	0.0015	0.0004	0.0001	0.0000	0.0000	0.0000	0.0000
113	0.0013	0.0003	0.0001	0.0000	0.0000	0.0000	0.0000
114	0.0012	0.0003	0.0001	0.0000	0.0000	0.0000	0.0000
115	0.0010	0.0002	0.0001	0.0000	0.0000	0.0000	0.0000
116	0.0009	0.0002	0.0001	0.0000	0.0000	0.0000	0.0000
117	0.0008	0.0001	0.0000	0.0000	0.0000	0.0000	0.0000
118	0.0007	0.0001	0.0000	0.0000	0.0000	0.0000	0.0000
119	0.0006	0.0001	0.0000	0.0000	0.0000	0.0000	0.0000
120	0.0005	0.0001	0.0000	0.0000	0.0000	0.0000	0.0000
121	0.0005	0.0001	0.0000	0.0000	0.0000	0.0000	0.0000
122	0.0004	0.0001	0.0000	0.0000	0.0000	0.0000	0.0000
123	0.0004	0.0001	0.0000	0.0000	0.0000	0.0000	0.0000
124	0.0003	0.0001	0.0000	0.0000	0.0000	0.0000	0.0000
125	0.0003	0.0001	0.0000	0.0000	0.0000	0.0000	0.0000
126	0.0003	0.0000	0.0000	0.0000	0.0000	0.0000	0.0000
127-130	0.0002	0.0000	0.0000	0.0000	0.0000	0.0000	0.0000
131-144	0.0001	0.0000	0.0000	0.0000	0.0000	0.0000	0.0000
≥145	0.0000	0.0000	0.0000	0.0000	0.0000	0.0000	0.0000

**Table 5-16: Daily Fraction of Stage 2 Treated Anthrax Non-Survivors (F<sub>DR,T-2</sub>) Who DOW**

Day	Dose Ranges (spores)*						
	≤10 <sup>2</sup>	10 <sup>2</sup> < - ≤10 <sup>3</sup>	10 <sup>3</sup> < - ≤10 <sup>4</sup>	10 <sup>4</sup> < - ≤10 <sup>5</sup>	10 <sup>5</sup> < - ≤10 <sup>6</sup>	10 <sup>6</sup> < - ≤10 <sup>7</sup>	>10 <sup>7</sup>
1	0.0000	0.0000	0.0000	0.0000	0.0000	0.0000	0.0000
2	0.0000	0.0000	0.0000	0.0000	0.0000	0.0004	0.0027
3	0.0001	0.0000	0.0001	0.0001	0.0009	0.0212	0.0480
4	0.0009	0.0010	0.0015	0.0034	0.0166	0.1020	0.1408
5	0.0051	0.0063	0.0098	0.0220	0.0721	0.1768	0.1908
6	0.0150	0.0197	0.0312	0.0631	0.1416	0.1893	0.1803
7	0.0302	0.0405	0.0627	0.1108	0.1759	0.1592	0.1418
8	0.0472	0.0632	0.0933	0.1420	0.1667	0.1176	0.1010
9	0.0621	0.0819	0.1133	0.1476	0.1342	0.0810	0.0682
10	0.0726	0.0930	0.1194	0.1330	0.0978	0.0537	0.0447
11	0.0778	0.0961	0.1137	0.1085	0.0672	0.0349	0.0289
12	0.0785	0.0928	0.1006	0.0825	0.0445	0.0224	0.0185
13	0.0755	0.0851	0.0841	0.0597	0.0290	0.0144	0.0119
14	0.0703	0.0751	0.0676	0.0418	0.0187	0.0093	0.0077
15	0.0637	0.0644	0.0526	0.0285	0.0120	0.0060	0.0050
16	0.0566	0.0540	0.0400	0.0191	0.0078	0.0039	0.0032
17	0.0496	0.0445	0.0299	0.0127	0.0050	0.0026	0.0021
18	0.0430	0.0363	0.0221	0.0084	0.0033	0.0017	0.0014
19	0.0370	0.0293	0.0161	0.0055	0.0022	0.0011	0.0010
20	0.0316	0.0235	0.0117	0.0037	0.0014	0.0008	0.0006
21	0.0269	0.0188	0.0084	0.0024	0.0010	0.0005	0.0004
22	0.0229	0.0150	0.0061	0.0016	0.0006	0.0004	0.0003
23	0.0194	0.0119	0.0044	0.0011	0.0004	0.0002	0.0002
24	0.0164	0.0095	0.0031	0.0007	0.0003	0.0002	0.0001

Day	Dose Ranges (spores)*						
	$\leq 10^2$	$10^2 < - \leq 10^3$	$10^3 < - \leq 10^4$	$10^4 < - \leq 10^5$	$10^5 < - \leq 10^6$	$10^6 < - \leq 10^7$	$> 10^7$
25	0.0139	0.0075	0.0023	0.0005	0.0002	0.0001	0.0001
26	0.0118	0.0060	0.0016	0.0003	0.0001	0.0001	0.0001
27	0.0100	0.0048	0.0012	0.0002	0.0001	0.0001	0.0001
28	0.0085	0.0038	0.0008	0.0002	0.0001	0.0000	0.0000
29	0.0073	0.0030	0.0006	0.0001	0.0001	0.0000	0.0000
30	0.0062	0.0024	0.0004	0.0001	0.0001	0.0000	0.0000
31	0.0053	0.0020	0.0003	0.0001	0.0001	0.0000	0.0000
32	0.0045	0.0016	0.0002	0.0001	0.0000	0.0000	0.0000
33	0.0039	0.0013	0.0002	0.0001	0.0000	0.0000	0.0000
34	0.0033	0.0010	0.0001	0.0001	0.0000	0.0000	0.0000
35	0.0029	0.0008	0.0001	0.0000	0.0000	0.0000	0.0000
36	0.0025	0.0007	0.0001	0.0000	0.0000	0.0000	0.0000
37	0.0021	0.0006	0.0001	0.0000	0.0000	0.0000	0.0000
38	0.0019	0.0005	0.0001	0.0000	0.0000	0.0000	0.0000
39	0.0016	0.0004	0.0001	0.0000	0.0000	0.0000	0.0000
40	0.0014	0.0003	0.0001	0.0000	0.0000	0.0000	0.0000
41	0.0012	0.0003	0.0000	0.0000	0.0000	0.0000	0.0000
42	0.0011	0.0002	0.0000	0.0000	0.0000	0.0000	0.0000
43	0.0009	0.0002	0.0000	0.0000	0.0000	0.0000	0.0000
44	0.0008	0.0001	0.0000	0.0000	0.0000	0.0000	0.0000
45	0.0007	0.0001	0.0000	0.0000	0.0000	0.0000	0.0000
46	0.0006	0.0001	0.0000	0.0000	0.0000	0.0000	0.0000
47	0.0006	0.0001	0.0000	0.0000	0.0000	0.0000	0.0000
48	0.0005	0.0001	0.0000	0.0000	0.0000	0.0000	0.0000
49	0.0004	0.0001	0.0000	0.0000	0.0000	0.0000	0.0000
50	0.0004	0.0001	0.0000	0.0000	0.0000	0.0000	0.0000
51-53	0.0003	0.0000	0.0000	0.0000	0.0000	0.0000	0.0000
54-58	0.0002	0.0000	0.0000	0.0000	0.0000	0.0000	0.0000
59-72	0.0001	0.0000	0.0000	0.0000	0.0000	0.0000	0.0000
$\geq 73$	0.0000	0.0000	0.0000	0.0000	0.0000	0.0000	0.0000

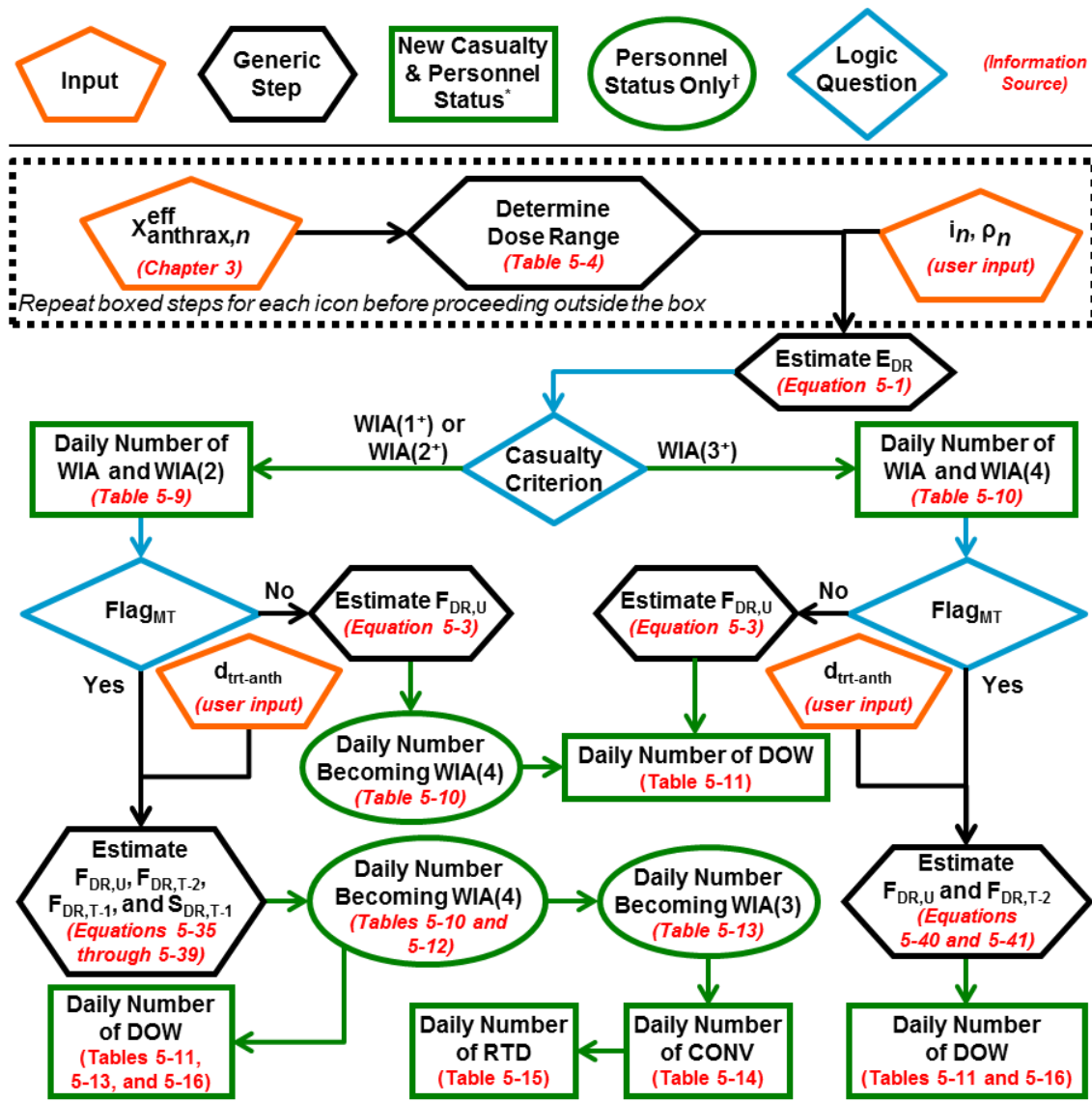

\* Casualty information (Pop<sub>cohort</sub>, CAT, table number) is passed to Equations 5-5 through 5-8.

† Personnel status information (Pop<sub>cohort</sub>, CAT, table number) is passed to Equation 5-7 and 5-8.

**Figure 5-3: Human Response and Casualty Estimation for Anthrax**

**5.2.2. Brucellosis**

1. Figure 5-4 summarizes the human response and casualty estimation processes for brucellosis, Table 5-17 summarizes the Injury Profile, and Table 5-18 summarizes the other brucellosis submodels. No prophylaxis is modeled for brucellosis.
2. Assumptions, limitation, and constraint.
  - a. Assumptions.
    - 1) The presentation and duration of brucellosis symptoms are independent of

the route of exposure.

- 2) Half of all cases are “abrupt,” and the other half are “insidious.”
  - 3) One organism, one cell, and one CFU are equivalent.
  - 4) Those who receive treatment will have a four week CONV period after their symptoms end (this period is reflected in the PDTs), before RTD.
- b. Limitation. Although the model requires the user to specify a day on which antibiotic treatment becomes available ( $d_{\text{trt-bruc}}$ ), it does *not* apply treatment to every person on that day; only those who have been declared WIA are modeled to begin receiving antibiotics on that day. Those who are declared WIA after  $d_{\text{trt-bruc}}$  are modeled to begin receiving antibiotics on the day they are declared WIA.
- c. Constraint. The models apply to *B. abortus*, *B. melitensis*, and *B. suis*.
3. Cohorts and special considerations.
- a. Brucellosis does not cause any fatalities, so no F cohort is used.
  - b. Brucellosis has two distinct clinical presentations, “abrupt” and “insidious” onset. Abrupt onset is immediately Severe, while insidious onset is first Mild, then Severe. The survivor cohorts are split between abrupt and insidious onset according to the assumption stated above.
  - c. If  $\text{Flag}_{\text{MT}} = \text{Yes}$ , an individual’s duration of illness depends upon the day on which antibiotic treatment becomes available. The user must specify the day on which antibiotic treatment becomes available for those declared WIA ( $d_{\text{trt-bruc}}$ ); based on the specified value, the population of E is split among several cohorts. Definitions of the cohorts and equations to calculate their populations are given below.
    - 1)  $S_{\text{abr,U}}$  is the number of individuals with abrupt onset who recover and RTD before  $d_{\text{trt-bruc}}$ .
    - 2)  $S_{\text{abr,T-WIA}}$  is the number of individuals with abrupt onset who are not yet WIA on  $d_{\text{trt-bruc}}$ , but will become WIA later and will receive antibiotic treatment when they become WIA.
    - 3)  $S_{\text{abr,T}}$  is the number of individuals with abrupt onset who in Stage 1 on  $d_{\text{trt-bruc}}$ , and begin receiving antibiotic treatment that day.
    - 4)  $S_{\text{ins,U}}$  is the number of individuals with insidious onset who recover and RTD before  $d_{\text{trt-bruc}}$ .
    - 5)  $S_{\text{ins,T-WIA}}$  is the number of individuals with insidious onset who are not yet



WIA on  $d_{\text{trt-bruc}}$ , but will become WIA later and will receive antibiotic treatment when they become WIA.

- 6)  $S_{\text{ins},T-1}$  is the number of individuals with insidious onset who are in Stage 1 on  $d_{\text{trt-bruc}}$ , and begin receiving antibiotic treatment that day.
- 7)  $S_{\text{ins},T-2}$  is the number of individuals with insidious onset who are in Stage 2 on  $d_{\text{trt-bruc}}$ , and begin receiving antibiotic treatment that day.

$$S_{\text{abr},U} = 0.5 \cdot E \cdot \sum_{d=1}^{d_{\text{trt-bruc}}} \text{PDT}_{5-21}(d) \quad (5-42)$$

$$S_{\text{abr},T-WIA} = 0.5 \cdot E \cdot \left( 1 - \sum_{d=1}^{d_{\text{trt-bruc}}} \text{PDT}_{5-19}(d) \right) \quad (5-43)$$

$$S_{\text{abr},T} = 0.5 \cdot E - (S_{\text{abr},U} + S_{\text{abr},T-WIA}) \quad (5-44)$$

$$S_{\text{ins},U} = 0.5 \cdot E \cdot \sum_{d=1}^{d_{\text{trt-bruc}}} \text{PDT}_{5-21}(d) \quad (5-45)$$

$$S_{\text{ins},T-WIA} = 0.5 \cdot E \cdot \left( 1 - \sum_{d=1}^{d_{\text{trt-bruc}}} \text{PDT}_{5-19}(d) \right) \quad (5-46)$$

- 8) If the casualty criterion is WIA(1+):

$$S_{\text{ins},T-2} = \left( 0.5 \cdot E \cdot \sum_{d=1}^{d_{\text{trt-bruc}}} \text{PDT}_{5-20}(d) \right) - S_{\text{ins},U} \quad (5-47)$$

$$S_{\text{ins},T-1} = 0.5 \cdot E - (S_{\text{ins},U} + S_{\text{ins},T-WIA} + S_{\text{ins},T-2}) \quad (5-48)$$

- 9) If the casualty criterion is WIA(2+) or WIA(3+):

$$S_{\text{ins},T-2} = 0.5 \cdot E - (S_{\text{ins},U} + S_{\text{ins},T-WIA}) \quad (5-49)$$

$$S_{\text{ins},T-1} = 0 \quad (5-50)$$

In Equations 5-42 to 5-50:

$d_{\text{trt-bruc}}$  is the user-specified day on which treatment begins, and  $\text{PDT}_{5-X}(d)$  reflect fractions of a specific population that have entered a certain stage of disease, as a function of a chosen day ( $d$ ), as dictated

by Table 5-X.

4. Table 5-19 through Table 5-25 are the PDTs for brucellosis. The values from a given table are to be used in Equations 5-5 through 5-8 with the cohort(s) listed in the table headers and footers, per Figure 5-4.

**Table 5-17: Brucellosis Injury Profile**

Stage	Injury Severity Level
Abrupt Onset Brucellosis ( $S_{abr,U}$ , $S_{abr,T-WIA}$ , $S_{abr,T}$ )	
1	3
Insidious Onset Brucellosis ( $S_{ins,U}$ , $S_{ins,T-WIA}$ , $S_{ins,T}$ )	
1	1
2	3
All Casualties Receiving Treatment ( $S_{abr,T-WIA}$ , $S_{abr,T}$ , $S_{ins,T-WIA}$ , $S_{ins,T}$ )	
CONV	CONV

**Table 5-18: Brucellosis Submodel Summary**

Type	Value
<b>Infectivity (<math>p_E(X_{bruc,n}^{eff})</math>)</b>	
Lognormal Distribution	Use Equation 5-32 ID <sub>50</sub> = 949 organisms Probit slope = 2.58 probits/log(dose)
<b>Lethality (<math>p_f(bruc)</math>)</b>	
CFR	0%
<b>Incubation Period *</b>	
Weibull Distribution	Mean = 63.63 days Standard deviation = 38.15 days
<b>Duration of Illness *</b>	
Total Duration: All Untreated ( $S_{abr,U}$ , $S_{ins,U}$ )	
Gamma Distribution	Mean = 70.7 days Standard deviation = 35.35 days
Stage 1: Insidious Onset, Untreated ( $S_{ins,U}$ ) or Treatment Initiated in Stage 2 ( $S_{ins,T-2}$ )	
Gamma Distribution	Mean = 30.87 days Standard deviation = 33.88 days
Stage 2: Insidious Onset, Untreated ( $S_{ins,U}$ )	
Difference between (Total Duration, Untreated) and (Stage 1, Insidious Onset, Untreated)	
Total Duration: All, Treatment Initiated Upon Becoming WIA ( $S_{abr,T-WIA}$ , $S_{ins,T-WIA}$ )	
Constant	14 days
Total Duration: All, Treatment Initiated in Stage 1 or Stage 2 ( $S_{abr,T}$ , $S_{ins,T-1}$ , $S_{ins,T-2}$ )	
Constant	14 days after $d_{trt-bruc}$
CONV: All, Treatment at Any Point ( $S_{abr,T-WIA}$ , $S_{abr,T}$ , $S_{ins,T-WIA}$ , $S_{ins,T}$ )	
Constant	28 days after end of symptoms

\* Presented for information only. These two submodels have already been convolved to generate the PDTs; the user should use the PDTs to estimate when changes in casualty category occur.

**Table 5-19: Daily Fraction of Individuals Ill with Insidious Onset Brucellosis ( $S_{ins,U}$ ,  $S_{ins,T-WIA}$ ,  $S_{ins,T-1}$ ,  $S_{ins,T-2}$ ) Who Become WIA, for Casualty Criterion WIA(1+); Daily Fraction of Individuals Ill with Abrupt Onset Brucellosis ( $S_{abr,U}$ ,  $S_{abr,T-WIA}$ ,  $S_{abr,T}$ ) Who Become WIA, for any Casualty Criterion\***

Day	Fraction	Day	Fraction	Day	Fraction	Day	Fraction	Day	Fraction
1	0.0006	29	0.0101	72	0.0088	100	0.0052	130	0.0023
2	0.0015	30	0.0103	73	0.0087	101	0.0051	131	0.0022
3	0.0021	31	0.0104	74	0.0086	102	0.0050	132-133	0.0021
4	0.0027	32	0.0105	75	0.0085	103	0.0049	134	0.0020
5	0.0033	33	0.0106	76	0.0083	104	0.0047	135-136	0.0019
6	0.0038	34-35	0.0107	77	0.0082	105	0.0046	137-138	0.0018
7	0.0042	36	0.0108	78	0.0081	106	0.0045	139	0.0017
8	0.0047	37-39	0.0109	79	0.0079	107	0.0044	140-141	0.0016
9	0.0051	40-47	0.0110	80	0.0078	108	0.0043	142-143	0.0015
10	0.0055	48-50	0.0109	81	0.0077	109	0.0042	144-145	0.0014
11	0.0058	51-52	0.0108	82	0.0075	110	0.0041	146-147	0.0013
12	0.0062	53-54	0.0107	83	0.0074	111	0.0040	148-150	0.0012
13	0.0065	55	0.0106	84	0.0073	112	0.0039	151-152	0.0011
14	0.0069	56	0.0105	85	0.0071	113	0.0038	153-155	0.0010
15	0.0072	57-58	0.0104	86	0.0070	114	0.0037	156-158	0.0009
16	0.0075	59	0.0103	87	0.0069	115	0.0036	159-161	0.0008
17	0.0077	60	0.0102	88	0.0067	116	0.0035	162-165	0.0007
18	0.0080	61	0.0101	89	0.0066	117	0.0034	166-169	0.0006
19	0.0083	62	0.0100	90	0.0065	118	0.0033	170-174	0.0005
20	0.0085	63	0.0099	91	0.0064	119	0.0032	175-180	0.0004
21	0.0087	64	0.0098	92	0.0062	120	0.0031	181-188	0.0003
22	0.0089	65	0.0097	93	0.0061	121	0.0030	189-199	0.0002
23	0.0091	66	0.0096	94	0.0060	122	0.0029	200-221	0.0001
24	0.0093	67	0.0094	95	0.0058	123	0.0028	≥222	0.0000
25	0.0095	68	0.0093	96	0.0057	124-125	0.0027		
26	0.0097	69	0.0092	97	0.0056	126	0.0026		
27	0.0098	70	0.0091	98	0.0055	127	0.0025		
28	0.0100	71	0.0090	99	0.0053	128-129	0.0024		

\* This equates to the time at which all cohorts enter Stage 1 (Severity Level 3 for abrupt onset, and Severity Level 1 for insidious onset).

**Table 5-20: Daily Fraction of Individuals Ill with Insidious Onset Brucellosis ( $S_{ins,U}$ ,  $S_{ins,T-WIA}$ ,  $S_{ins,T-2}$ ) Who Become WIA, for Casualty Criterion WIA(2+) or WIA(3+)\***

Day	Fraction	Day	Fraction	Day	Fraction	Day	Fraction	Day	Fraction
1	0.0000	31	0.0050	67-76	0.0086	119-120	0.0057	157-158	0.0028
2-3	0.0001	32	0.0052	77-80	0.0085	121	0.0056	159-160	0.0027
4	0.0002	33	0.0054	81-82	0.0084	122	0.0055	161	0.0026
5	0.0004	34	0.0055	83-85	0.0083	123	0.0054	162-163	0.0025
6	0.0005	35	0.0057	86-87	0.0082	124	0.0053	164-165	0.0024
7	0.0006	36	0.0058	88-89	0.0081	125	0.0052	166-167	0.0023
8	0.0008	37	0.0060	90	0.0080	126-127	0.0051	168-169	0.0022
9	0.0009	38	0.0062	91-92	0.0079	128	0.0050	170-171	0.0021
10	0.0011	39	0.0063	93-94	0.0078	129	0.0049	172-173	0.0020
11	0.0013	40	0.0064	95	0.0077	130	0.0048	174-175	0.0019
12	0.0014	41	0.0066	96	0.0076	131	0.0047	175-178	0.0018
13	0.0016	42	0.0067	97-98	0.0075	132-133	0.0046	179-180	0.0017

Day	Fraction	Day	Fraction	Day	Fraction	Day	Fraction	Day	Fraction
14	0.0018	43	0.0069	99	0.0074	134	0.0045	181-183	0.0016
15	0.0020	44	0.0070	100	0.0073	135	0.0044	184-185	0.0015
16	0.0022	45	0.0071	101-102	0.0072	136	0.0043	186-188	0.0014
17	0.0024	46	0.0072	103	0.0071	137-138	0.0042	189-191	0.0013
18	0.0026	47	0.0073	104	0.0070	139	0.0041	192-195	0.0012
19	0.0028	48	0.0074	105-106	0.0069	140	0.0040	196-198	0.0011
20	0.0029	49	0.0075	107	0.0068	141-142	0.0039	199-202	0.0010
21	0.0031	50	0.0076	108	0.0067	143	0.0038	203-206	0.0009
22	0.0033	51	0.0077	109	0.0066	144	0.0037	207-211	0.0008
23	0.0035	52	0.0078	110	0.0065	145-146	0.0036	212-217	0.0007
24	0.0037	53	0.0079	111-112	0.0064	147	0.0035	218-223	0.0006
25	0.0039	54	0.0080	113	0.0063	148-149	0.0034	224-230	0.0005
26	0.0041	55-56	0.0081	114	0.0062	150	0.0033	231-240	0.0004
27	0.0043	57-58	0.0082	115	0.0061	151-152	0.0032	241-252	0.0003
28	0.0045	59-60	0.0083	116	0.0060	153	0.0031	253-269	0.0002
29	0.0047	61-62	0.0084	117	0.0059	154-155	0.0030	270-318	0.0001
30	0.0048	63-66	0.0085	118	0.0058	156	0.0029	≥319	0.0000

\* This equates to the time at which the  $S_{ins,U}$  and  $S_{ins,T-2}$  cohorts enter Stage 2 (Severity Level 3).

**Table 5-21: Daily Fraction of Untreated Insidious Onset Brucellosis Survivors ( $S_{ins,U}$ ) or Abrupt Onset Brucellosis Survivors ( $S_{abr,U}$ ) Who Become RTD\***

Day	Fraction	Day	Fraction	Day	Fraction	Day	Fraction	Day	Fraction
1-17	0.0000	61	0.0033	92	0.0069	157	0.0061	199	0.0030
18-23	0.0001	62	0.0035	93	0.0070	158	0.0060	200	0.0029
24-26	0.0002	63	0.0036	94	0.0071	159-160	0.0059	202-203	0.0028
27-29	0.0003	64	0.0037	95	0.0072	161	0.0058	204	0.0027
30-31	0.0004	65	0.0039	96	0.0072	162	0.0057	205-206	0.0026
32-33	0.0005	66	0.0040	97	0.0073	163	0.0056	207-208	0.0025
34	0.0006	67	0.0041	98	0.0074	164-165	0.0055	209-210	0.0024
35-36	0.0007	68	0.0042	99	0.0074	166	0.0054	211	0.0023
37	0.0008	69	0.0044	100	0.0075	167	0.0053	212-213	0.0022
38-39	0.0009	70	0.0045	101	0.0075	168-169	0.0052	214-215	0.0021
40	0.0010	71	0.0046	102-103	0.0076	170	0.0051	216-217	0.0020
41	0.0011	72	0.0048	104-106	0.0077	171	0.0050	219-220	0.0019
42	0.0012	73	0.0049	107-109	0.0078	172	0.0049	221-222	0.0018
43	0.0013	74	0.0050	110-124	0.0079	173-174	0.0048	223-224	0.0017
44	0.0014	75	0.0051	125-128	0.0078	175	0.0047	225-227	0.0016
45	0.0015	76	0.0053	129-131	0.0077	176	0.0046	228-229	0.0015
46	0.0016	77	0.0054	132-133	0.0076	177-178	0.0045	230-232	0.0014
47	0.0017	78	0.0055	134-135	0.0075	179	0.0044	233-235	0.0013
48	0.0018	79	0.0056	136-137	0.0074	180	0.0043	236-238	0.0012
49	0.0019	80	0.0057	138-139	0.0073	181-182	0.0042	239-241	0.0011
50	0.0020	81	0.0059	140-141	0.0072	183	0.0041	242-245	0.0010
51	0.0021	82	0.0060	142-143	0.0071	184	0.0040	246-249	0.0009
52	0.0022	83	0.0061	144	0.0070	185-186	0.0039	250-253	0.0008
53	0.0023	84	0.0062	145-146	0.0069	187	0.0038	254-258	0.0007
54	0.0025	85	0.0063	147	0.0068	188-189	0.0037	259-264	0.0006
55	0.0026	86	0.0064	148-149	0.0067	190	0.0036	265-270	0.0005
56	0.0027	87	0.0065	150	0.0066	191-192	0.0035	271-278	0.0004
57	0.0028	88	0.0066	151-152	0.0065	193	0.0034	279-289	0.0003
58	0.0030	89	0.0067	153	0.0064	194-194	0.0033	290-304	0.0002
59	0.0031	90	0.0068	154	0.0063	196	0.0032	305-334	0.0001
60	0.0032	91	0.0068	155-156	0.0062	197-198	0.0031	≥335	0.0000

**Table 5-22: Daily Fraction of Abrupt Onset Brucellosis Casualties Treated Upon Becoming WIA ( $S_{abr,T-WIA}$ ) Who Become CONV\*;  
Daily Fraction of Insidious Onset Brucellosis Casualties Treated Upon Becoming WIA ( $S_{ins,T-WIA}$ ) Who Become CONV, for Casualty Criterion WIA(1+)\***

Day	Fraction	Day	Fraction	Day	Fraction	Day	Fraction
15	0.0006 / $X_{norm}$	50	0.0108 / $X_{norm}$	98	0.0073 / $X_{norm}$	132	0.0033 / $X_{norm}$
16	0.0015 / $X_{norm}$	51–53	0.0109 / $X_{norm}$	99	0.0071 / $X_{norm}$	133	0.0032 / $X_{norm}$
17	0.0021 / $X_{norm}$	54–61	0.0110 / $X_{norm}$	100	0.0070 / $X_{norm}$	134	0.0031 / $X_{norm}$
18	0.0027 / $X_{norm}$	62–64	0.0109 / $X_{norm}$	101	0.0069 / $X_{norm}$	135	0.0030 / $X_{norm}$
19	0.0033 / $X_{norm}$	65–66	0.0108 / $X_{norm}$	102	0.0067 / $X_{norm}$	136	0.0029 / $X_{norm}$
20	0.0038 / $X_{norm}$	67–68	0.0107 / $X_{norm}$	103	0.0066 / $X_{norm}$	137	0.0028 / $X_{norm}$
21	0.0042 / $X_{norm}$	69	0.0106 / $X_{norm}$	104	0.0065 / $X_{norm}$	138–139	0.0027 / $X_{norm}$
22	0.0047 / $X_{norm}$	70	0.0105 / $X_{norm}$	105	0.0064 / $X_{norm}$	140	0.0026 / $X_{norm}$
23	0.0051 / $X_{norm}$	71–72	0.0104 / $X_{norm}$	106	0.0062 / $X_{norm}$	141	0.0025 / $X_{norm}$
24	0.0055 / $X_{norm}$	73	0.0103 / $X_{norm}$	107	0.0061 / $X_{norm}$	142–143	0.0024 / $X_{norm}$
25	0.0058 / $X_{norm}$	74	0.0102 / $X_{norm}$	108	0.0060 / $X_{norm}$	144	0.0023 / $X_{norm}$
26	0.0062 / $X_{norm}$	75	0.0101 / $X_{norm}$	109	0.0058 / $X_{norm}$	145	0.0022 / $X_{norm}$
27	0.0065 / $X_{norm}$	76	0.0100 / $X_{norm}$	110	0.0057 / $X_{norm}$	146–147	0.0021 / $X_{norm}$
28	0.0069 / $X_{norm}$	77	0.0099 / $X_{norm}$	111	0.0056 / $X_{norm}$	148	0.0020 / $X_{norm}$
29	0.0072 / $X_{norm}$	78	0.0098 / $X_{norm}$	112	0.0055 / $X_{norm}$	149–150	0.0019 / $X_{norm}$
30	0.0075 / $X_{norm}$	79	0.0097 / $X_{norm}$	113	0.0053 / $X_{norm}$	151–152	0.0018 / $X_{norm}$
31	0.0077 / $X_{norm}$	80	0.0096 / $X_{norm}$	114	0.0052 / $X_{norm}$	153	0.0017 / $X_{norm}$
32	0.0080 / $X_{norm}$	81	0.0094 / $X_{norm}$	115	0.0051 / $X_{norm}$	154–155	0.0016 / $X_{norm}$
33	0.0083 / $X_{norm}$	82	0.0093 / $X_{norm}$	116	0.0050 / $X_{norm}$	156–167	0.0015 / $X_{norm}$
34	0.0085 / $X_{norm}$	83	0.0092 / $X_{norm}$	117	0.0049 / $X_{norm}$	158–159	0.0014 / $X_{norm}$
35	0.0087 / $X_{norm}$	84	0.0091 / $X_{norm}$	118	0.0047 / $X_{norm}$	160–161	0.0013 / $X_{norm}$
36	0.0089 / $X_{norm}$	85	0.0090 / $X_{norm}$	119	0.0046 / $X_{norm}$	162–164	0.0012 / $X_{norm}$
37	0.0091 / $X_{norm}$	86	0.0088 / $X_{norm}$	120	0.0045 / $X_{norm}$	165–166	0.0011 / $X_{norm}$
38	0.0093 / $X_{norm}$	87	0.0087 / $X_{norm}$	121	0.0044 / $X_{norm}$	167–169	0.0010 / $X_{norm}$
39	0.0095 / $X_{norm}$	88	0.0086 / $X_{norm}$	122	0.0043 / $X_{norm}$	170–172	0.0009 / $X_{norm}$
40	0.0097 / $X_{norm}$	89	0.0085 / $X_{norm}$	123	0.0042 / $X_{norm}$	173–175	0.0008 / $X_{norm}$
41	0.0098 / $X_{norm}$	90	0.0083 / $X_{norm}$	124	0.0041 / $X_{norm}$	176–179	0.0007 / $X_{norm}$
42	0.0100 / $X_{norm}$	91	0.0082 / $X_{norm}$	125	0.0040 / $X_{norm}$	180–183	0.0006 / $X_{norm}$
43	0.0101 / $X_{norm}$	92	0.0081 / $X_{norm}$	126	0.0039 / $X_{norm}$	184–188	0.0005 / $X_{norm}$
44	0.0103 / $X_{norm}$	93	0.0079 / $X_{norm}$	127	0.0038 / $X_{norm}$	189–194	0.0004 / $X_{norm}$
45	0.0104 / $X_{norm}$	94	0.0078 / $X_{norm}$	128	0.0037 / $X_{norm}$	195–202	0.0003 / $X_{norm}$
46	0.0105 / $X_{norm}$	95	0.0077 / $X_{norm}$	129	0.0036 / $X_{norm}$	203–213	0.0002 / $X_{norm}$
47	0.0106 / $X_{norm}$	96	0.0075 / $X_{norm}$	130	0.0035 / $X_{norm}$	214–235	0.0001 / $X_{norm}$
48–49	0.0107 / $X_{norm}$	97	0.0074 / $X_{norm}$	131	0.0034 / $X_{norm}$	≥236	0.0000

\* This equates to the time at which these cohorts exit their final stage of disease. This table is only used for day  $\geq (14 + d_{trt-bruc})$ . Accordingly,  $X_{norm} = \sum_{d_{trt-bruc}}^{221} PDT_{5-19}(d)$ .

**Table 5-23: Daily Fraction of Insidious Onset Brucellosis Casualties Treated Upon Becoming WIA ( $S_{ins,T-WIA}$ ) Who Become CONV, for Casualty Criterion WIA(2+) or WIA(3+)\***

Day	Fraction	Day	Fraction	Day	Fraction	Day	Fraction
≤15	0.0000	53	0.0063 / $X_{norm}$	118	0.0070 / $X_{norm}$	164	0.0033 / $X_{norm}$
16–17	0.0001 / $X_{norm}$	54	0.0064 / $X_{norm}$	119–120	0.0069 / $X_{norm}$	165–166	0.0032 / $X_{norm}$
18	0.0002 / $X_{norm}$	55	0.0066 / $X_{norm}$	121	0.0068 / $X_{norm}$	167	0.0031 / $X_{norm}$
19	0.0004 / $X_{norm}$	56	0.0067 / $X_{norm}$	122	0.0067 / $X_{norm}$	168–169	0.0030 / $X_{norm}$
20	0.0005 / $X_{norm}$	57	0.0069 / $X_{norm}$	123	0.0066 / $X_{norm}$	170	0.0029 / $X_{norm}$
21	0.0006 / $X_{norm}$	58	0.0070 / $X_{norm}$	124	0.0065 / $X_{norm}$	171–172	0.0028 / $X_{norm}$

Day	Fraction	Day	Fraction	Day	Fraction	Day	Fraction
22	0.0008 / X <sub>norm</sub>	59	0.0071 / X <sub>norm</sub>	125-126	0.0064 / X <sub>norm</sub>	173-174	0.0027 / X <sub>norm</sub>
23	0.0009 / X <sub>norm</sub>	60	0.0072 / X <sub>norm</sub>	127	0.0063 / X <sub>norm</sub>	175	0.0026 / X <sub>norm</sub>
24	0.0011 / X <sub>norm</sub>	61	0.0073 / X <sub>norm</sub>	128	0.0062 / X <sub>norm</sub>	176-177	0.0025 / X <sub>norm</sub>
25	0.0013 / X <sub>norm</sub>	62	0.0074 / X <sub>norm</sub>	129	0.0061 / X <sub>norm</sub>	178-179	0.0024 / X <sub>norm</sub>
26	0.0014 / X <sub>norm</sub>	63	0.0075 / X <sub>norm</sub>	130	0.0060 / X <sub>norm</sub>	180-181	0.0023 / X <sub>norm</sub>
27	0.0016 / X <sub>norm</sub>	64	0.0076 / X <sub>norm</sub>	131	0.0059 / X <sub>norm</sub>	182-183	0.0022 / X <sub>norm</sub>
28	0.0018 / X <sub>norm</sub>	65	0.0077 / X <sub>norm</sub>	132	0.0058 / X <sub>norm</sub>	184-185	0.0021 / X <sub>norm</sub>
29	0.0020 / X <sub>norm</sub>	66	0.0078 / X <sub>norm</sub>	133-134	0.0057 / X <sub>norm</sub>	186-187	0.0020 / X <sub>norm</sub>
30	0.0022 / X <sub>norm</sub>	67	0.0079 / X <sub>norm</sub>	135	0.0056 / X <sub>norm</sub>	188-189	0.0019 / X <sub>norm</sub>
31	0.0024 / X <sub>norm</sub>	68	0.0080 / X <sub>norm</sub>	136	0.0055 / X <sub>norm</sub>	190-192	0.0018 / X <sub>norm</sub>
32	0.0026 / X <sub>norm</sub>	69-70	0.0081 / X <sub>norm</sub>	137	0.0054 / X <sub>norm</sub>	193-194	0.0017 / X <sub>norm</sub>
33	0.0028 / X <sub>norm</sub>	61-72	0.0082 / X <sub>norm</sub>	138	0.0053 / X <sub>norm</sub>	195-197	0.0016 / X <sub>norm</sub>
34	0.0029 / X <sub>norm</sub>	73-74	0.0083 / X <sub>norm</sub>	139	0.0052 / X <sub>norm</sub>	198-199	0.0015 / X <sub>norm</sub>
35	0.0031 / X <sub>norm</sub>	75-76	0.0084 / X <sub>norm</sub>	140-141	0.0051 / X <sub>norm</sub>	200-202	0.0014 / X <sub>norm</sub>
36	0.0033 / X <sub>norm</sub>	77-80	0.0085 / X <sub>norm</sub>	142	0.0050 / X <sub>norm</sub>	203-205	0.0013 / X <sub>norm</sub>
37	0.0035 / X <sub>norm</sub>	81-90	0.0086 / X <sub>norm</sub>	143	0.0049 / X <sub>norm</sub>	206-209	0.0012 / X <sub>norm</sub>
38	0.0037 / X <sub>norm</sub>	91-94	0.0085 / X <sub>norm</sub>	144	0.0048 / X <sub>norm</sub>	210-212	0.0011 / X <sub>norm</sub>
39	0.0039 / X <sub>norm</sub>	95-96	0.0084 / X <sub>norm</sub>	145	0.0047 / X <sub>norm</sub>	213-216	0.0010 / X <sub>norm</sub>
40	0.0041 / X <sub>norm</sub>	97-99	0.0083 / X <sub>norm</sub>	146-147	0.0046 / X <sub>norm</sub>	217-220	0.0009 / X <sub>norm</sub>
41	0.0043 / X <sub>norm</sub>	100-101	0.0082 / X <sub>norm</sub>	148	0.0045 / X <sub>norm</sub>	221-225	0.0008 / X <sub>norm</sub>
42	0.0045 / X <sub>norm</sub>	102-103	0.0081 / X <sub>norm</sub>	149	0.0044 / X <sub>norm</sub>	226-231	0.0007 / X <sub>norm</sub>
43	0.0047 / X <sub>norm</sub>	104	0.0080 / X <sub>norm</sub>	150	0.0043 / X <sub>norm</sub>	232-237	0.0006 / X <sub>norm</sub>
44	0.0048 / X <sub>norm</sub>	105-106	0.0079 / X <sub>norm</sub>	151-152	0.0042 / X <sub>norm</sub>	238-244	0.0005 / X <sub>norm</sub>
45	0.0050 / X <sub>norm</sub>	107-108	0.0078 / X <sub>norm</sub>	153	0.0041 / X <sub>norm</sub>	245-254	0.0004 / X <sub>norm</sub>
46	0.0052 / X <sub>norm</sub>	109	0.0077 / X <sub>norm</sub>	154	0.0040 / X <sub>norm</sub>	255-266	0.0003 / X <sub>norm</sub>
47	0.0054 / X <sub>norm</sub>	110	0.0076 / X <sub>norm</sub>	155-156	0.0039 / X <sub>norm</sub>	267-283	0.0002 / X <sub>norm</sub>
48	0.0055 / X <sub>norm</sub>	111-112	0.0075 / X <sub>norm</sub>	157	0.0038 / X <sub>norm</sub>	284-332	0.0001 / X <sub>norm</sub>
49	0.0057 / X <sub>norm</sub>	113	0.0074 / X <sub>norm</sub>	158	0.0037 / X <sub>norm</sub>	≥333	0.0000
50	0.0058 / X <sub>norm</sub>	114	0.0073 / X <sub>norm</sub>	159-160	0.0036 / X <sub>norm</sub>		
51	0.0060 / X <sub>norm</sub>	115-116	0.0072 / X <sub>norm</sub>	161	0.0035 / X <sub>norm</sub>		
52	0.0062 / X <sub>norm</sub>	117	0.0071 / X <sub>norm</sub>	162-163	0.0034 / X <sub>norm</sub>		

\* This equates to the time at which this cohort exits its final stage of disease. This table is only used for day ≥ (14 + d<sub>trt-bruc</sub>). Accordingly, X<sub>norm</sub> = Σ<sub>d<sub>trt-bruc</sub></sub><sup>318</sup> PDT<sub>5-20</sub>(d).

**Table 5-24: Daily Fraction of Abrupt Onset Brucellosis Casualties Treated Upon Becoming WIA (S<sub>abr,T-WIA</sub>) Who Become RTD\*;  
Daily Fraction of Insidious Onset Brucellosis Casualties Treated Upon Becoming WIA (S<sub>ins,T-WIA</sub>) Who Become RTD, for Casualty Criterion WIA(1+)\***

Day	Fraction	Day	Fraction	Day	Fraction	Day	Fraction
43	0.0006 / X <sub>norm</sub>	78	0.0108 / X <sub>norm</sub>	126	0.0073 / X <sub>norm</sub>	160	0.0033 / X <sub>norm</sub>
44	0.0015 / X <sub>norm</sub>	79-81	0.0109 / X <sub>norm</sub>	127	0.0071 / X <sub>norm</sub>	161	0.0032 / X <sub>norm</sub>
45	0.0021 / X <sub>norm</sub>	82-89	0.0110 / X <sub>norm</sub>	128	0.0070 / X <sub>norm</sub>	162	0.0031 / X <sub>norm</sub>
46	0.0027 / X <sub>norm</sub>	90-92	0.0109 / X <sub>norm</sub>	129	0.0069 / X <sub>norm</sub>	163	0.0030 / X <sub>norm</sub>
47	0.0033 / X <sub>norm</sub>	93-94	0.0108 / X <sub>norm</sub>	130	0.0067 / X <sub>norm</sub>	164	0.0029 / X <sub>norm</sub>
48	0.0038 / X <sub>norm</sub>	95-96	0.0107 / X <sub>norm</sub>	131	0.0066 / X <sub>norm</sub>	165	0.0028 / X <sub>norm</sub>
49	0.0042 / X <sub>norm</sub>	97	0.0106 / X <sub>norm</sub>	132	0.0065 / X <sub>norm</sub>	166-167	0.0027 / X <sub>norm</sub>
50	0.0047 / X <sub>norm</sub>	98	0.0105 / X <sub>norm</sub>	133	0.0064 / X <sub>norm</sub>	168	0.0026 / X <sub>norm</sub>
51	0.0051 / X <sub>norm</sub>	99-100	0.0104 / X <sub>norm</sub>	134	0.0062 / X <sub>norm</sub>	169	0.0025 / X <sub>norm</sub>
52	0.0055 / X <sub>norm</sub>	101	0.0103 / X <sub>norm</sub>	135	0.0061 / X <sub>norm</sub>	170-171	0.0024 / X <sub>norm</sub>
53	0.0058 / X <sub>norm</sub>	102	0.0102 / X <sub>norm</sub>	136	0.0060 / X <sub>norm</sub>	172	0.0023 / X <sub>norm</sub>
54	0.0062 / X <sub>norm</sub>	103	0.0101 / X <sub>norm</sub>	137	0.0058 / X <sub>norm</sub>	173	0.0022 / X <sub>norm</sub>

Day	Fraction	Day	Fraction	Day	Fraction	Day	Fraction
55	0.0065 / X <sub>norm</sub>	104	0.0100 / X <sub>norm</sub>	138	0.0057 / X <sub>norm</sub>	174-175	0.0021 / X <sub>norm</sub>
56	0.0069 / X <sub>norm</sub>	105	0.0099 / X <sub>norm</sub>	139	0.0056 / X <sub>norm</sub>	176	0.0020 / X <sub>norm</sub>
57	0.0072 / X <sub>norm</sub>	106	0.0098 / X <sub>norm</sub>	140	0.0055 / X <sub>norm</sub>	177-178	0.0019 / X <sub>norm</sub>
58	0.0075 / X <sub>norm</sub>	107	0.0097 / X <sub>norm</sub>	141	0.0053 / X <sub>norm</sub>	179-180	0.0018 / X <sub>norm</sub>
59	0.0077 / X <sub>norm</sub>	108	0.0096 / X <sub>norm</sub>	142	0.0052 / X <sub>norm</sub>	181	0.0017 / X <sub>norm</sub>
60	0.0080 / X <sub>norm</sub>	109	0.0094 / X <sub>norm</sub>	143	0.0051 / X <sub>norm</sub>	182-183	0.0016 / X <sub>norm</sub>
61	0.0083 / X <sub>norm</sub>	110	0.0093 / X <sub>norm</sub>	144	0.0050 / X <sub>norm</sub>	184-185	0.0015 / X <sub>norm</sub>
62	0.0085 / X <sub>norm</sub>	111	0.0092 / X <sub>norm</sub>	145	0.0049 / X <sub>norm</sub>	186-187	0.0014 / X <sub>norm</sub>
63	0.0087 / X <sub>norm</sub>	112	0.0091 / X <sub>norm</sub>	146	0.0047 / X <sub>norm</sub>	188-189	0.0013 / X <sub>norm</sub>
64	0.0089 / X <sub>norm</sub>	113	0.0090 / X <sub>norm</sub>	147	0.0046 / X <sub>norm</sub>	190-192	0.0012 / X <sub>norm</sub>
65	0.0091 / X <sub>norm</sub>	114	0.0088 / X <sub>norm</sub>	148	0.0045 / X <sub>norm</sub>	193-194	0.0011 / X <sub>norm</sub>
66	0.0093 / X <sub>norm</sub>	115	0.0087 / X <sub>norm</sub>	149	0.0044 / X <sub>norm</sub>	195-197	0.0010 / X <sub>norm</sub>
67	0.0095 / X <sub>norm</sub>	116	0.0086 / X <sub>norm</sub>	150	0.0043 / X <sub>norm</sub>	198-200	0.0009 / X <sub>norm</sub>
68	0.0097 / X <sub>norm</sub>	117	0.0085 / X <sub>norm</sub>	151	0.0042 / X <sub>norm</sub>	201-203	0.0008 / X <sub>norm</sub>
69	0.0098 / X <sub>norm</sub>	118	0.0083 / X <sub>norm</sub>	152	0.0041 / X <sub>norm</sub>	204-207	0.0007 / X <sub>norm</sub>
70	0.0100 / X <sub>norm</sub>	119	0.0082 / X <sub>norm</sub>	153	0.0040 / X <sub>norm</sub>	208-211	0.0006 / X <sub>norm</sub>
71	0.0101 / X <sub>norm</sub>	120	0.0081 / X <sub>norm</sub>	154	0.0039 / X <sub>norm</sub>	212-216	0.0005 / X <sub>norm</sub>
72	0.0103 / X <sub>norm</sub>	121	0.0079 / X <sub>norm</sub>	155	0.0038 / X <sub>norm</sub>	217-122	0.0004 / X <sub>norm</sub>
73	0.0104 / X <sub>norm</sub>	122	0.0078 / X <sub>norm</sub>	156	0.0037 / X <sub>norm</sub>	223-230	0.0003 / X <sub>norm</sub>
74	0.0105 / X <sub>norm</sub>	123	0.0077 / X <sub>norm</sub>	157	0.0036 / X <sub>norm</sub>	231-241	0.0002 / X <sub>norm</sub>
75	0.0106 / X <sub>norm</sub>	124	0.0075 / X <sub>norm</sub>	158	0.0035 / X <sub>norm</sub>	242-263	0.0001 / X <sub>norm</sub>
76-77	0.0107 / X <sub>norm</sub>	125	0.0074 / X <sub>norm</sub>	159	0.0034 / X <sub>norm</sub>	≥264	0.0000

\* This equates to the time at which these cohorts exit their convalescence period. This table is only used for day ≥ (42 + d<sub>trt-bruc</sub>). Accordingly, X<sub>norm</sub> = Σ<sub>d<sub>trt-bruc</sub></sub><sup>221</sup> PDT<sub>5-19</sub>(d).

**Table 5-25: Daily Fraction of Insidious Onset Brucellosis Casualties Treated Upon Becoming WIA (S<sub>ins,T-WIA</sub>) Who Become RTD, for Casualty Criterion WIA(2<sup>+</sup>) or WIA(3<sup>+</sup>)\***

Day	Fraction	Day	Fraction	Day	Fraction	Day	Fraction
≤43	0.0000	81	0.0063 / X <sub>norm</sub>	146	0.0070 / X <sub>norm</sub>	192	0.0033 / X <sub>norm</sub>
44-45	0.0001 / X <sub>norm</sub>	82	0.0064 / X <sub>norm</sub>	147-148	0.0069 / X <sub>norm</sub>	193-194	0.0032 / X <sub>norm</sub>
46	0.0002 / X <sub>norm</sub>	83	0.0066 / X <sub>norm</sub>	149	0.0068 / X <sub>norm</sub>	195	0.0031 / X <sub>norm</sub>
47	0.0004 / X <sub>norm</sub>	84	0.0067 / X <sub>norm</sub>	150	0.0067 / X <sub>norm</sub>	196-197	0.0030 / X <sub>norm</sub>
48	0.0005 / X <sub>norm</sub>	85	0.0069 / X <sub>norm</sub>	151	0.0066 / X <sub>norm</sub>	198	0.0029 / X <sub>norm</sub>
49	0.0006 / X <sub>norm</sub>	86	0.0070 / X <sub>norm</sub>	152	0.0065 / X <sub>norm</sub>	199-200	0.0028 / X <sub>norm</sub>
50	0.0008 / X <sub>norm</sub>	87	0.0071 / X <sub>norm</sub>	153-154	0.0064 / X <sub>norm</sub>	201-202	0.0027 / X <sub>norm</sub>
51	0.0009 / X <sub>norm</sub>	88	0.0072 / X <sub>norm</sub>	155	0.0063 / X <sub>norm</sub>	203	0.0026 / X <sub>norm</sub>
52	0.0011 / X <sub>norm</sub>	89	0.0073 / X <sub>norm</sub>	156	0.0062 / X <sub>norm</sub>	204-205	0.0025 / X <sub>norm</sub>
53	0.0013 / X <sub>norm</sub>	90	0.0074 / X <sub>norm</sub>	157	0.0061 / X <sub>norm</sub>	206-207	0.0024 / X <sub>norm</sub>
54	0.0014 / X <sub>norm</sub>	91	0.0075 / X <sub>norm</sub>	158	0.0060 / X <sub>norm</sub>	208-209	0.0023 / X <sub>norm</sub>
55	0.0016 / X <sub>norm</sub>	92	0.0076 / X <sub>norm</sub>	159	0.0059 / X <sub>norm</sub>	210-211	0.0022 / X <sub>norm</sub>
56	0.0018 / X <sub>norm</sub>	93	0.0077 / X <sub>norm</sub>	160	0.0058 / X <sub>norm</sub>	212-213	0.0021 / X <sub>norm</sub>
57	0.0020 / X <sub>norm</sub>	94	0.0078 / X <sub>norm</sub>	161-162	0.0057 / X <sub>norm</sub>	214-215	0.0020 / X <sub>norm</sub>
58	0.0022 / X <sub>norm</sub>	95	0.0079 / X <sub>norm</sub>	163	0.0056 / X <sub>norm</sub>	216-217	0.0019 / X <sub>norm</sub>
59	0.0024 / X <sub>norm</sub>	96	0.0080 / X <sub>norm</sub>	164	0.0055 / X <sub>norm</sub>	218-220	0.0018 / X <sub>norm</sub>
60	0.0026 / X <sub>norm</sub>	97-98	0.0081 / X <sub>norm</sub>	165	0.0054 / X <sub>norm</sub>	221-222	0.0017 / X <sub>norm</sub>
61	0.0028 / X <sub>norm</sub>	99-100	0.0082 / X <sub>norm</sub>	166	0.0053 / X <sub>norm</sub>	223-225	0.0016 / X <sub>norm</sub>
62	0.0029 / X <sub>norm</sub>	101-102	0.0083 / X <sub>norm</sub>	167	0.0052 / X <sub>norm</sub>	226-227	0.0015 / X <sub>norm</sub>
63	0.0031 / X <sub>norm</sub>	103-104	0.0084 / X <sub>norm</sub>	168-169	0.0051 / X <sub>norm</sub>	228-230	0.0014 / X <sub>norm</sub>
64	0.0033 / X <sub>norm</sub>	105-108	0.0085 / X <sub>norm</sub>	170	0.0050 / X <sub>norm</sub>	231-233	0.0013 / X <sub>norm</sub>
65	0.0035 / X <sub>norm</sub>	109-118	0.0086 / X <sub>norm</sub>	171	0.0049 / X <sub>norm</sub>	234-237	0.0012 / X <sub>norm</sub>
66	0.0037 / X <sub>norm</sub>	119-122	0.0085 / X <sub>norm</sub>	172	0.0048 / X <sub>norm</sub>	238-240	0.0011 / X <sub>norm</sub>

Day	Fraction	Day	Fraction	Day	Fraction	Day	Fraction
67	0.0039 / X <sub>norm</sub>	123–124	0.0084 / X <sub>norm</sub>	173	0.0047 / X <sub>norm</sub>	241–244	0.0010 / X <sub>norm</sub>
68	0.0041 / X <sub>norm</sub>	125–127	0.0083 / X <sub>norm</sub>	174–175	0.0046 / X <sub>norm</sub>	245–248	0.0009 / X <sub>norm</sub>
69	0.0043 / X <sub>norm</sub>	128–129	0.0082 / X <sub>norm</sub>	176	0.0045 / X <sub>norm</sub>	249–243	0.0008 / X <sub>norm</sub>
70	0.0045 / X <sub>norm</sub>	130–131	0.0081 / X <sub>norm</sub>	177	0.0044 / X <sub>norm</sub>	254–249	0.0007 / X <sub>norm</sub>
71	0.0047 / X <sub>norm</sub>	132	0.0080 / X <sub>norm</sub>	178	0.0043 / X <sub>norm</sub>	260–245	0.0006 / X <sub>norm</sub>
72	0.0048 / X <sub>norm</sub>	133–134	0.0079 / X <sub>norm</sub>	179–180	0.0042 / X <sub>norm</sub>	266–272	0.0005 / X <sub>norm</sub>
73	0.0050 / X <sub>norm</sub>	135–136	0.0078 / X <sub>norm</sub>	181	0.0041 / X <sub>norm</sub>	273–282	0.0004 / X <sub>norm</sub>
74	0.0052 / X <sub>norm</sub>	137	0.0077 / X <sub>norm</sub>	182	0.0040 / X <sub>norm</sub>	283–294	0.0003 / X <sub>norm</sub>
75	0.0054 / X <sub>norm</sub>	138	0.0076 / X <sub>norm</sub>	183–184	0.0039 / X <sub>norm</sub>	295–301	0.0002 / X <sub>norm</sub>
76	0.0055 / X <sub>norm</sub>	139–140	0.0075 / X <sub>norm</sub>	185	0.0038 / X <sub>norm</sub>	302–360	0.0001 / X <sub>norm</sub>
77	0.0057 / X <sub>norm</sub>	141	0.0074 / X <sub>norm</sub>	186	0.0037 / X <sub>norm</sub>	≥361	0.0000
78	0.0058 / X <sub>norm</sub>	142	0.0073 / X <sub>norm</sub>	187–188	0.0036 / X <sub>norm</sub>		
79	0.0060 / X <sub>norm</sub>	143–144	0.0072 / X <sub>norm</sub>	189	0.0035 / X <sub>norm</sub>		
80	0.0062 / X <sub>norm</sub>	145	0.0071 / X <sub>norm</sub>	190–191	0.0034 / X <sub>norm</sub>		

\* This equates to the time at which this cohort exits its convalescent period. This table is only used for day  $\geq (42 + d_{\text{trt-bruc}})$ . Accordingly,  $X_{\text{norm}} = \sum_{d_{\text{trt-bruc}}}^{318} \text{PDT}_{5-20}(d)$ .

**Table 5-26: Daily Fraction of Stage 1 Treated Brucellosis Survivors (S<sub>abr,T</sub>, S<sub>ins,T-1</sub>) and Stage 2 Treated Brucellosis Survivors (S<sub>ins,T-2</sub>) Who Become CONV**

Day	Fraction
$< 14 + d_{\text{trt-bruc}}$	0.0000
$14 + d_{\text{trt-bruc}}$	1.0000
$> 14 + d_{\text{trt-bruc}}$	0.0000

**Table 5-27: Daily Fraction of Stage 1 Treated Brucellosis Survivors (S<sub>abr,T</sub>, S<sub>ins,T-1</sub>) and Stage 2 Treated Brucellosis Survivors (S<sub>ins,T-2</sub>) Who Become RTD**

Day	Fraction
$< 42 + d_{\text{trt-bruc}}$	0.0000
$42 + d_{\text{trt-bruc}}$	1.0000
$> 42 + d_{\text{trt-bruc}}$	0.0000



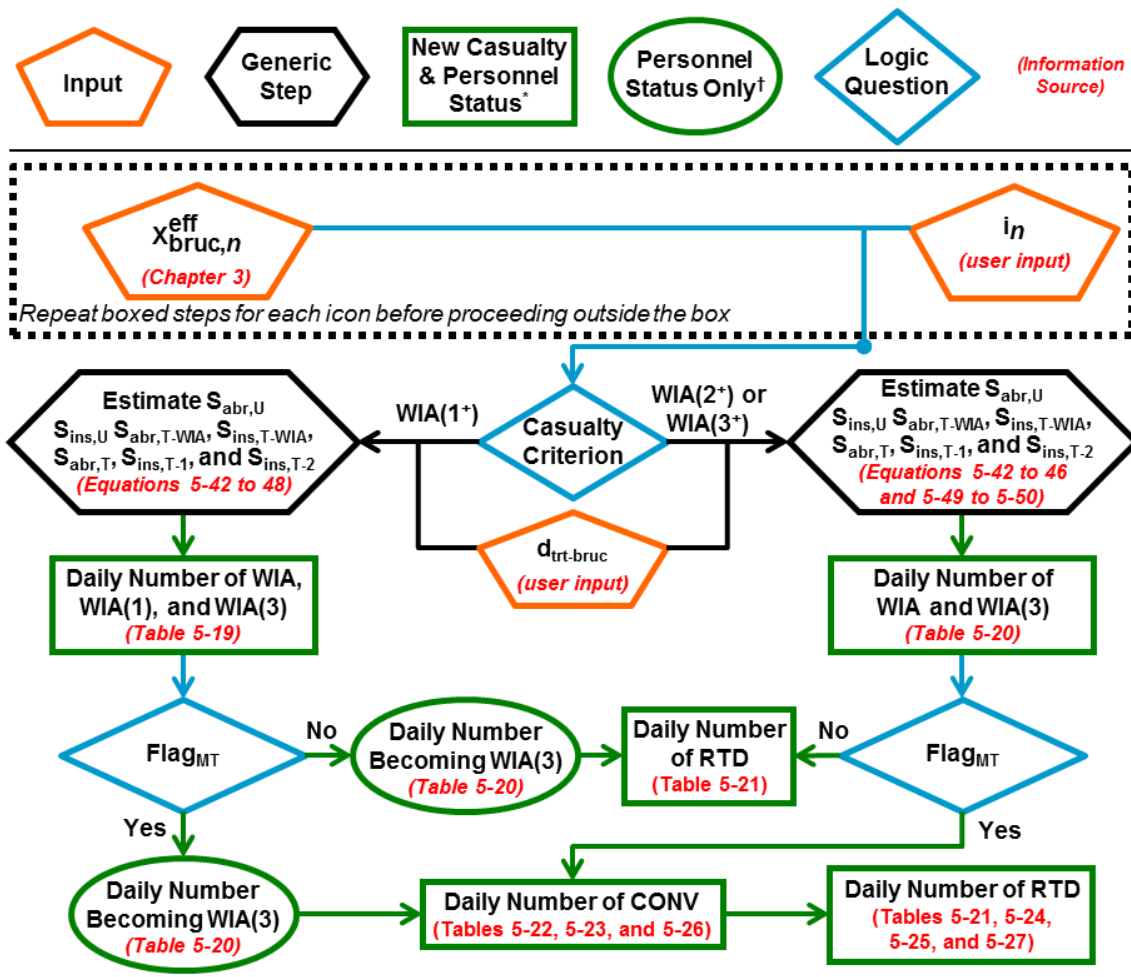

\* Casualty information ( $Pop_{cohort}$ , CAT, table number) is passed to Equations 5-5 through 5-8.  
 † Personnel status information ( $Pop_{cohort}$ , CAT, table number) is passed to Equation 5-7 and 5-8.

Figure 5-4: Human Response and Casualty Estimation for Brucellosis

### 5.2.3. Glanders

1. Figure 5-5 summarizes the human response and casualty estimation processes for glanders, Table 5-28 summarizes the Injury Profile, and Table 5-29 summarizes the other glanders submodels. No prophylaxis is modeled for glanders.
2. Assumptions.
  - a. Human response to *B. mallei* is independent of the route of exposure.
  - b. Untreated survivors are unable to RTD because of chronic glanders.
  - c. When  $Flag_{MT} = \text{Yes}$ , WIAs begin receiving treatment on the first day they are declared WIA.
3. Cohorts and special considerations.

- a. If  $\text{Flag}_{\text{MT}} = \text{No}$ , the population of the E cohort moves into  $F_U$  and  $S_U$  according to Equations 5-3 and 5-4.
  - b. When  $\text{Flag}_{\text{MT}} = \text{Yes}$ , all personnel will survive because the CFR for treated glanders is 0%. Personnel will follow the untreated duration of illness model until they are declared WIA, at which point it is assumed they will begin receiving antibiotic treatment.
    - 1) If the casualty criterion is WIA(1+), the population of E moves into  $S_{T-1}$ .
    - 2) If the casualty criterion is WIA(2+), the population of E moves into  $S_{T-2}$ .
    - 3) If the casualty criterion is WIA(3+), the population of E moves into  $S_{T-3}$  (see note below Table 5-32).
4. Table 5-30 through Table 5-39 are the PDTs for glanders. The values from a given table are to be used in Equations 5-5 through 5-8 with the cohort(s) listed in the table headers and footers, per Figure 5-5.

**Table 5-28: Glanders Injury Profile**

Stage	Injury Severity Level
Untreated Glanders Survivors ( $S_U$ )	
1	1
2	2
3	3
4 (chronic glanders)	1
Untreated Glanders Non-Survivors ( $F_U$ )	
1	1
2	2
3	3
Treated Glanders Survivors ( $S_{T-1}$ , $S_{T-2}$ , and $S_{T-3}$ )	
1	1
2	2
3	1

**Table 5-29: Glanders Submodel Summary**

Type	Value
<b>Infectivity (<math>\rho_F(X_{\text{glan},n}^{\text{eff}})</math>)</b>	
Lognormal Distribution	Use Equation 5-32 ID <sub>50</sub> = 24.5 organisms Probit slope = 1.93 probits/log(dose)
<b>Lethality (<math>\rho_f(\text{glan})</math>)</b>	
Untreated	
CFR	70%
Treated	
CFR	0%
<b>Incubation Period*</b>	
Lognormal Distribution	Mean = 8.29 days Standard deviation = 13.0 days
<b>Duration of Illness*</b>	

Type	Value
Stage 1: Untreated ( $F_U$ and $S_U$ )	
Stage 1: Treatment Initiated in Stage 2 or 3 ( $S_{T-2}$ and $S_{T-3}$ )	
Weibull Distribution	Mean = 6.9 days Standard deviation = 3.8 days
Stage 2: Untreated ( $F_U$ and $S_U$ )	
Stage 2: Treatment Initiated in Stage 3 ( $S_{T-3}$ )	
Weibull Distribution	Mean = 10.4 days Standard deviation = 5.7 days
Stage 3: Untreated ( $F_U$ and $S_U$ )	
Weibull Distribution	Mean = 5.8 days Standard deviation = 3.2 days
Stage 4: Untreated Survivors ( $S_U$ )	
Constant	indefinite
Stage 1: Treatment Initiated in Stage 1 ( $S_{T-1}$ )	
Constant	7 days
Stage 2: Treatment Initiated in Stage 1 or 2 ( $S_{T-1}$ and $S_{T-2}$ )	
Constant	14 days
Stage 3: Treatment Initiated in Stage 1, 2, or 3 ( $S_{T-1}$ , $S_{T-2}$ , and $S_{T-3}$ )	
Constant	70 days

\* Presented for information only. These two submodels have already been convolved to generate the PDTs; the user should use the PDTs to estimate when changes in casualty category occur.

**Table 5-30: Daily Fraction of Individuals Ill with Glanders (E) Who Become WIA, for Casualty Criterion WIA(1+)\***

Day	Fraction	Day	Fraction	Day	Fraction	Day	Fraction	Day	Fraction
1	0.0899	12	0.0217	23	0.0056	34	0.0021	48-49	0.0008
2	0.1461	13	0.0187	24	0.0050	35	0.0019	50-51	0.0007
3	0.1252	14	0.0162	25	0.0046	36	0.0018	52-54	0.0006
4	0.1002	15	0.0141	26	0.0041	37	0.0017	55-57	0.0005
5	0.0798	16	0.0124	27	0.0038	38	0.0015	58-62	0.0004
6	0.0641	17	0.0109	28	0.0034	39	0.0014	63-69	0.0003
7	0.0521	18	0.0097	29	0.0032	40-41	0.0013	70-81	0.0002
8	0.0429	19	0.0086	30	0.0029	42	0.0012	82-118	0.0001
9	0.0357	20	0.0077	31	0.0027	43	0.0011	≥119	0.00000
10	0.0300	21	0.0069	32	0.0024	44-45	0.0010		
11	0.0254	22	0.0062	33	0.0022	46-47	0.0009		

\* This equates to the time at which all cohorts enter Stage 1 (Severity Level 1).

**Table 5-31: Daily Fraction of Individuals Ill with Glanders (E) Who Become WIA, for Casualty Criterion WIA(2+)\***

Day	Fraction	Day	Fraction	Day	Fraction	Day	Fraction	Day	Fraction
1	0.0003	14	0.0526	27	0.0089	40	0.0024	55-56	0.0008
2	0.0039	15	0.0471	28	0.0079	41	0.0022	57-58	0.0007
3	0.0118	16	0.0416	29	0.0070	42	0.0020	59-61	0.0006
4	0.0225	17	0.0364	30	0.0062	43	0.0019	62-65	0.0005
5	0.0341	18	0.0316	31	0.0056	44	0.0018	66-70	0.0004
6	0.0450	19	0.0273	32	0.0050	45	0.0016	71-77	0.0003
7	0.0542	20	0.0235	33	0.0046	46	0.0015	78-88	0.0002
8	0.0608	21	0.0202	34	0.0041	47	0.0014	89-127	0.0001
9	0.0648	22	0.0175	35	0.0037	48	0.0013	≥128	0.00000
10	0.0660	23	0.0151	36	0.0034	49	0.0012		
11	0.0650	24	0.0131	37	0.0031	50-51	0.0011		

Day	Fraction	Day	Fraction	Day	Fraction	Day	Fraction	Day	Fraction
12	0.0620	25	0.0115	38	0.0029	52	0.0010		
13	0.0577	26	0.0101	39	0.0026	53-54	0.0009		

\* This equates to the time at which the  $F_U$ ,  $S_U$ ,  $S_{T-2}$  and  $S_{T-3}$  cohorts enter Stage 2 (Severity Level 2).

**Table 5-32: Daily Fraction of Individuals III with Glanders (E) Who Become WIA, for Casualty Criterion WIA(3+)\***

Day	Fraction	Day	Fraction	Day	Fraction	Day	Fraction	Day	Fraction
1-2	0.0000	17	0.0398	32	0.0226	47	0.0041	62-63	0.0011
3	0.0001	18	0.0421	33	0.0204	48	0.0037	64	0.0010
4	0.0004	19	0.0436	34	0.0183	49	0.0034	65-66	0.0009
5	0.0010	20	0.0445	35	0.0163	50	0.0031	67-68	0.0008
6	0.0021	21	0.0447	36	0.0146	51	0.0028	69-70	0.0007
7	0.0039	22	0.0442	37	0.0129	52	0.0025	71-73	0.0006
8	0.0062	23	0.0432	38	0.0115	53	0.0023	74-76	0.0005
9	0.0092	24	0.0417	39	0.0102	54	0.0021	77-81	0.0004
10	0.0128	25	0.0398	40	0.0091	55	0.0019	82-88	0.0003
11	0.0167	26	0.0376	41	0.0081	56	0.0018	89-99	0.0002
12	0.0210	27	0.0352	42	0.0072	57	0.0017	100-141	0.0001
13	0.0253	28	0.0327	43	0.0064	58	0.0015	≥142	0.00000
14	0.0295	29	0.0301	44	0.0057	59	0.0014		
15	0.0334	30	0.0276	45	0.0051	60	0.0013		
16	0.0369	31	0.0251	46	0.0046	61	0.0012		

\* This equates to the time at which the  $F_U$ ,  $S_U$ , and  $S_{T-3}$  cohorts enter Stage 3 (Severity Level 3).

Although the  $S_{T-3}$  cohort enters Stage 3 at Severity Level 3, it is assumed that antibiotic treatment quickly reduces the severity to Severity Level 1, consistent with the Injury Profile. Thus, in Figure 5-5, they are reported as WIA(1) per Table 5-32.

**Table 5-33: Daily Fraction of Untreated Glanders Non-Survivors ( $F_U$ ) Who DOW**

Day	Fraction	Day	Fraction	Day	Fraction	Day	Fraction	Day	Fraction
≤5	0.0000	20	0.0295	35	0.0293	50	0.0060	65	0.0014
6	0.0001	21	0.0326	36	0.0271	51	0.0054	66	0.0013
7	0.0003	22	0.0354	37	0.0248	52	0.0048	67-68	0.0012
8	0.0006	23	0.0377	38	0.0226	53	0.0043	69	0.0011
9	0.0012	24	0.0395	39	0.0205	54	0.0039	70	0.0010
10	0.0020	25	0.0408	40	0.0185	55	0.0035	71-72	0.0009
11	0.0032	26	0.0415	41	0.0167	56	0.0032	73-74	0.0008
12	0.0049	27	0.0416	42	0.0150	57	0.0029	75-76	0.0007
13	0.0069	28	0.0413	43	0.0134	58	0.0026	77-79	0.0006
14	0.0095	29	0.0405	44	0.0120	59	0.0024	80-83	0.0005
15	0.0124	30	0.0392	45	0.0107	60	0.0022	84-87	0.0004
16	0.0156	31	0.0377	46	0.0095	61	0.0020	88-94	0.0003
17	0.0190	32	0.0358	47	0.0085	62	0.0018	95-106	0.0002
18	0.0225	33	0.0338	48	0.0076	63	0.0017	107-147	0.0001
19	0.0261	34	0.0316	49	0.0067	64	0.0016	≥148	0.0000

\* This equates to the time at which the  $S_U$  cohort enters Stage 4 (Severity Level 1).

**Table 5-34: Daily Fraction of Stage 1 Treated Glanders Survivors ( $S_{T-1}$ ) Who Enter Stage 2**

Day	Fraction	Day	Fraction	Day	Fraction	Day	Fraction	Day	Fraction
≤7	0.0000	18	0.0254	29	0.0062	40	0.0022	53–54	0.0009
8	0.0899	19	0.0217	30	0.0056	41	0.0021	55–56	0.0008
9	0.1461	20	0.0187	31	0.0050	42	0.0019	57–58	0.0007
10	0.1252	21	0.0162	32	0.0046	43	0.0018	59–61	0.0006
11	0.1002	22	0.0141	33	0.0041	44	0.0017	62–64	0.0005
12	0.0798	23	0.0124	34	0.0038	45	0.0015	65–69	0.0004
13	0.0641	24	0.0109	35	0.0034	46	0.0014	70–76	0.0003
14	0.0521	25	0.0097	36	0.0032	47–48	0.0013	77–88	0.0002
15	0.0429	26	0.0086	37	0.0029	49	0.0012	89–125	0.0001
16	0.0357	27	0.0077	38	0.0027	50	0.0011	≥126	0.00000
17	0.0300	28	0.0069	39	0.0024	51–52	0.0010		

**Table 5-35: Daily Fraction of Stage 1 Treated Glanders Survivors ( $S_{T-1}$ ) Who Enter Stage 3**

Day	Fraction	Day	Fraction	Day	Fraction	Day	Fraction	Day	Fraction
≤21	0.0000	32	0.0254	43	0.0062	54	0.0022	67–68	0.0009
22	0.0899	33	0.0217	44	0.0056	55	0.0021	69–70	0.0008
23	0.1461	34	0.0187	45	0.0050	56	0.0019	71–72	0.0007
24	0.1252	35	0.0162	46	0.0046	57	0.0018	73–75	0.0006
25	0.1002	36	0.0141	47	0.0041	58	0.0017	76–78	0.0005
26	0.0798	37	0.0124	48	0.0038	59	0.0015	79–83	0.0004
27	0.0641	38	0.0109	49	0.0034	60	0.0014	84–90	0.0003
28	0.0521	39	0.0097	50	0.0032	61–62	0.0013	91–92	0.0002
29	0.0429	40	0.0086	51	0.0029	63	0.0012	93–139	0.0001
30	0.0357	41	0.0077	52	0.0027	64	0.0011	≥140	0.00000
31	0.0300	42	0.0069	53	0.0024	65–66	0.0010		

**Table 5-36: Daily Fraction of Stage 1 Treated Glanders Survivors ( $S_{T-1}$ ) Who Become RTD**

Day	Fraction	Day	Fraction	Day	Fraction	Day	Fraction	Day	Fraction
≤91	0.0000	102	0.0254	113	0.0062	124	0.0022	137–138	0.0009
92	0.0899	103	0.0217	114	0.0056	125	0.0021	139–140	0.0008
93	0.1461	104	0.0187	115	0.0050	126	0.0019	141–142	0.0007
94	0.1252	105	0.0162	116	0.0046	127	0.0018	143–145	0.0006
95	0.1002	106	0.0141	117	0.0041	128	0.0017	146–148	0.0005
96	0.0798	107	0.0124	118	0.0038	129	0.0015	149–153	0.0004
97	0.0641	108	0.0109	119	0.0034	130	0.0014	154–160	0.0003
98	0.0521	109	0.0097	120	0.0032	131–132	0.0013	161–172	0.0002
99	0.0429	110	0.0086	121	0.0029	133	0.0012	163–209	0.0001
100	0.0357	111	0.0077	122	0.0027	134	0.0011	≥210	0.00000
101	0.0300	112	0.0069	123	0.0024	135–136	0.0010		

**Table 5-37: Daily Fraction of Stage 2 Treated Glanders Survivors ( $S_{T-2}$ ) Who Enter Stage 3**

Day	Fraction	Day	Fraction	Day	Fraction	Day	Fraction	Day	Fraction
≤14	0.0000	27	0.0577	40	0.0101	53	0.0026	67–68	0.0009
15	0.0003	28	0.0526	41	0.0089	54	0.0024	69–70	0.0008
16	0.0039	29	0.0471	42	0.0079	55	0.0022	71–72	0.0007
17	0.0118	30	0.0416	43	0.0070	56	0.0020	73–75	0.0006

Day	Fraction	Day	Fraction	Day	Fraction	Day	Fraction	Day	Fraction
18	0.0225	31	0.0364	44	0.0062	57	0.0019	76-80	0.0005
19	0.0341	32	0.0316	45	0.0056	58	0.0018	80-94	0.0004
20	0.0450	33	0.0273	46	0.0050	59	0.0016	85-91	0.0003
21	0.0542	34	0.0235	47	0.0046	60	0.0015	92-102	0.0002
22	0.0608	35	0.0202	48	0.0041	61	0.0014	103-141	0.0001
23	0.0648	36	0.0175	49	0.0037	62	0.0013	≥142	0.00000
24	0.0660	37	0.0151	50	0.0034	63	0.0012		
25	0.0650	38	0.0131	51	0.0031	64-65	0.0011		
26	0.0620	39	0.0115	52	0.0029	66	0.0010		

**Table 5-38: Daily Fraction of Stage 2 Treated Glanders Survivors (S<sub>T-2</sub>) Who Become RTD**

Day	Fraction	Day	Fraction	Day	Fraction	Day	Fraction	Day	Fraction
≤84	0.0000	97	0.0577	110	0.0101	123	0.0026	137-138	0.0009
85	0.0003	98	0.0526	111	0.0089	124	0.0024	139-140	0.0008
86	0.0039	99	0.0471	112	0.0079	125	0.0022	141-142	0.0007
87	0.0118	100	0.0416	113	0.0070	126	0.0020	143-145	0.0006
88	0.0225	101	0.0364	114	0.0062	127	0.0019	146-150	0.0005
89	0.0341	102	0.0316	115	0.0056	128	0.0018	150-164	0.0004
90	0.0450	103	0.0273	116	0.0050	129	0.0016	155-161	0.0003
91	0.0542	104	0.0235	117	0.0046	130	0.0015	162-172	0.0002
92	0.0608	105	0.0202	118	0.0041	131	0.0014	173-211	0.0001
93	0.0648	106	0.0175	119	0.0037	132	0.0013	≥212	0.00000
94	0.0660	107	0.0151	120	0.0034	133	0.0012		
95	0.0650	108	0.0131	121	0.0031	134-135	0.0011		
96	0.0620	109	0.0115	122	0.0029	136	0.0010		

**Table 5-39: Daily Fraction of Stage 3 Treated Glanders Survivors (S<sub>T-3</sub>) Who Become RTD**

Day	Fraction	Day	Fraction	Day	Fraction	Day	Fraction	Day	Fraction
71-72	0.0000	87	0.0398	102	0.0226	117	0.0041	132-133	0.0011
73	0.0001	88	0.0421	103	0.0204	118	0.0037	134	0.0010
74	0.0004	89	0.0436	104	0.0183	119	0.0034	135-136	0.0009
75	0.0010	90	0.0445	105	0.0163	120	0.0031	137-138	0.0008
76	0.0021	91	0.0447	106	0.0146	121	0.0028	139-140	0.0007
77	0.0039	92	0.0442	107	0.0129	122	0.0025	141-143	0.0006
78	0.0062	93	0.0432	108	0.0115	123	0.0023	144-146	0.0005
79	0.0092	94	0.0417	109	0.0102	124	0.0021	147-151	0.0004
80	0.0128	95	0.0398	110	0.0091	125	0.0019	152-158	0.0003
81	0.0167	96	0.0376	111	0.0081	126	0.0018	159-169	0.0002
82	0.0210	97	0.0352	112	0.0072	127	0.0017	170-211	0.0001
83	0.0253	98	0.0327	113	0.0064	128	0.0015	≥212	0.00000
84	0.0295	99	0.0301	114	0.0057	129	0.0014		
85	0.0334	100	0.0276	115	0.0051	130	0.0013		
86	0.0369	101	0.0251	116	0.0046	131	0.0012		

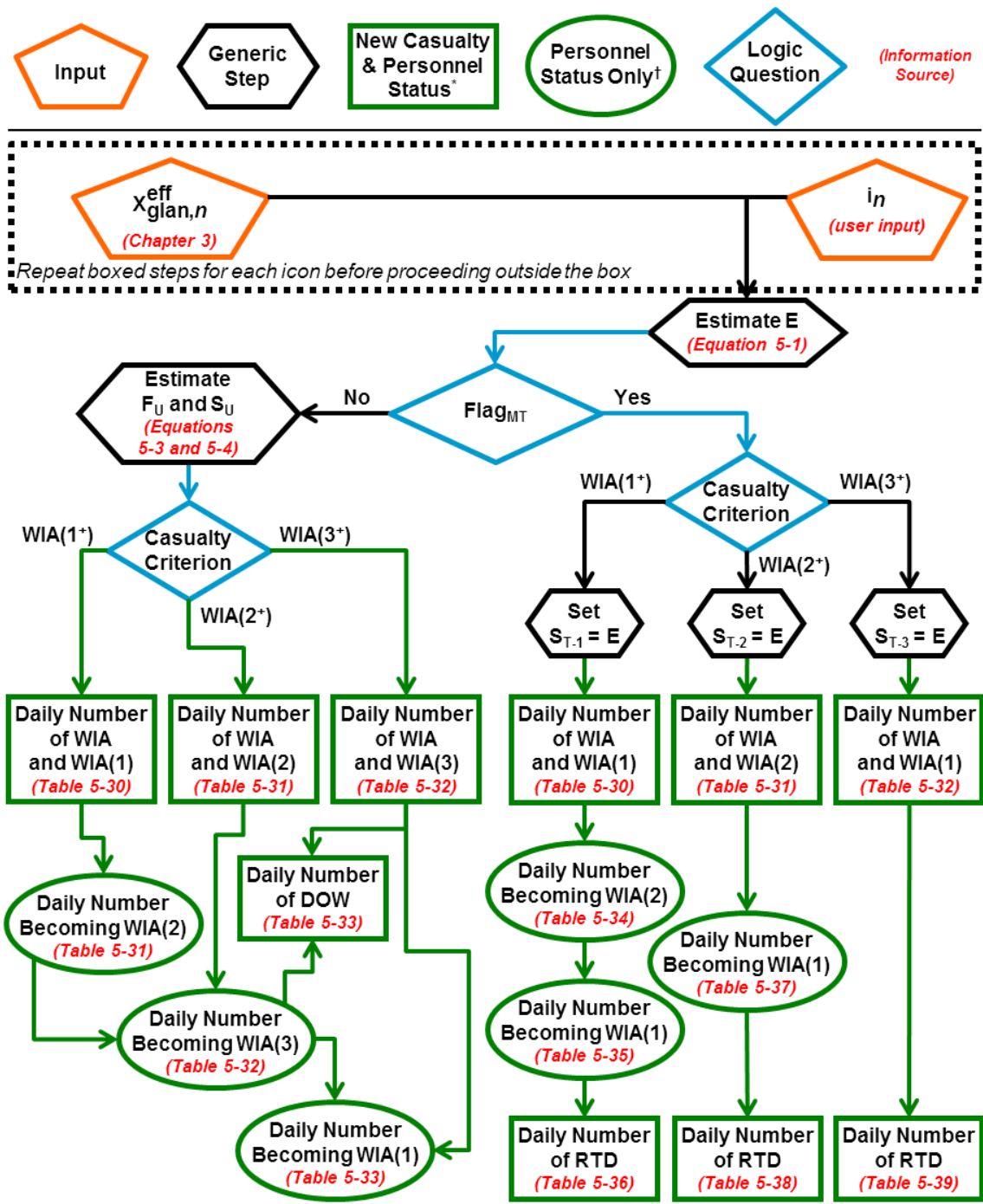

\* Casualty information ( $Pop_{cohort}$ , CAT, table number) is passed to Equations 5-5 through 5-8.

† Personnel status information ( $Pop_{cohort}$ , CAT, table number) is passed to Equation 5-7 and 5-8.

Figure 5-5: Human Response and Casualty Estimation for Glanders

### 5.2.4. Melioidosis

1. Figure 5-6 summarizes the human response and casualty estimation processes for melioidosis, Table 5-40 summarizes the Injury Profile, and Table 5-41 summarizes the other melioidosis submodels. No prophylaxis is modeled for melioidosis.
2. Assumption and limitations.
  - a. Assumption. The population does not have melioidosis risk factors.
  - b. Limitations.
    - 1) The methodology only accounts for acute onset melioidosis with pulmonary presentation.
    - 2) Although the model requires the user to specify a day on which antibiotic treatment becomes available ( $d_{\text{trt-meli}}$ ), it does *not* apply treatment to every person on that day; only those who have been declared WIA are modeled to begin receiving antibiotics on that day. Those who are declared WIA after  $d_{\text{trt-meli}}$  are modeled to begin receiving antibiotics on the day they are declared WIA.
3. Cohorts and special considerations.
  - a. If  $\text{Flag}_{\text{MT}} = \text{No}$ , the population of the E cohort (calculated by Equation 5-1) moves into  $F_U$  and  $S_U$  according to Equations 5-3 and 5-4.
  - b. If  $\text{Flag}_{\text{MT}} = \text{Yes}$ , an individual's duration of illness and outcome depend upon the day on which antibiotic treatment becomes available. The user must specify the day on which antibiotic treatment becomes available for those declared WIA ( $d_{\text{trt-meli}}$ ); based on the specified value, the population of E is split among several cohorts. Definitions of the cohorts and equations to calculate their populations are given below.
    - 1)  $F_U$  is the number of individuals who die before  $d_{\text{trt-meli}}$ .
    - 2)  $S_U$  is the number of individuals who recover and RTD before  $d_{\text{trt-meli}}$ .
    - 3)  $F_{\text{T-WIA}}$  is the number of individuals who are not yet WIA on  $d_{\text{trt-meli}}$ , but will become WIA later, and will die despite starting antibiotic treatment on the first day they become WIA.
    - 4)  $S_{\text{T-WIA}}$  is the number of individuals who are not yet WIA on  $d_{\text{trt-meli}}$ , but will become WIA later, will start antibiotic treatment on the first day they become WIA, and will survive and RTD.
    - 5)  $F_{\text{T-1}}$  is the number of individuals who are in Stage 1 on  $d_{\text{trt-meli}}$  that will die despite receiving antibiotic treatment.



- 6)  $S_{T-1}$  is the number of individuals who are in Stage 1 on  $d_{\text{trt-meli}}$  that will survive and RTD.
- 7)  $F_{T-2}$  is the number of individuals who are in Stage 2 on  $d_{\text{trt-meli}}$  that will die despite receiving antibiotic treatment.
- 8)  $S_{T-2}$  is the number of individuals who are in Stage 2 on  $d_{\text{trt-meli}}$  that will survive and RTD.

$$F_U = E \cdot p_{f-U}(\text{meli}) \cdot \sum_{d=1}^{d_{\text{trt-meli}}} \text{PDT}_{5-44}(d) \quad (5-51)$$

$$S_U = E \cdot (1 - p_{f-U}(\text{meli})) \cdot \sum_{d=1}^{d_{\text{trt-meli}}} \text{PDT}_{5-45}(d) \quad (5-52)$$

$$F_{T-WIA} = E \cdot p_{f-T}(\text{meli}) \cdot \left( 1 - \sum_{d=1}^{d_{\text{trt-meli}}} \text{PDT}_{5-42}(d) \right) \quad (5-53)$$

$$S_{T-WIA} = \frac{F_{T-WIA} \cdot (1 - p_{f-T}(\text{meli}))}{p_{f-T}(\text{meli})} \quad (5-54)$$

$$F_{T-2} = p_{f-T}(\text{meli}) \cdot \left( \left( E \cdot \sum_{d=1}^{d_{\text{trt-meli}}} \text{PDT}_{5-43}(d) \right) - (F_U + S_U) \right) \quad (5-55)$$

$$S_{T-2} = \frac{F_{T-2} \cdot (1 - p_{f-T}(\text{meli}))}{p_{f-T}(\text{meli})} \quad (5-56)$$

$$F_{T-1} = (E - (F_U + S_U + F_{T-WIA} + S_{T-WIA} + F_{T-2} + S_{T-2})) \cdot p_{f-T}(\text{meli}) \quad (5-57)$$

$$S_{T-1} = \frac{F_{T-1} \cdot (1 - p_{f-T}(\text{meli}))}{p_{f-T}(\text{meli})} \quad (5-58)$$

In Equations 5-51 to 5-58:

$d_{\text{trt-meli}}$  is the user-specified day on which treatment begins,

$\text{PDT}_{5-X}(d)$  reflect fractions of a specific population that have entered a certain stage of disease, as a function of a chosen day (d), as dictated by Table 5-X, and

$p_{f-U}(\text{meli})$  and  $p_{f-T}(\text{meli})$  are the case fatality rates for melioidosis without and with treatment, respectively.

4. Table 5-42 through Table 5-47 are the PDTs for melioidosis. The values from a given table are to be used in Equations 5-5 through 5-8 with the cohort(s) listed in the table headers and footers, per Figure 5-6.

**Table 5-40: Melioidosis Injury Profile**

Stage	Injury Severity Level
All Survivors ( $S_U$ , $S_{T-WIA}$ , $S_{T-1}$ , and $S_{T-2}$ )	
1	3
2	2
All Non-Survivors ( $F_U$ , $F_{T-WIA}$ , $F_{T-1}$ , and $F_{T-2}$ )	
1	3
2	4

**Table 5-41: Melioidosis Submodel Summary**

Type	Value
<b>Infectivity (<math>p_E(X_{\text{meli},n}^{\text{eff}})</math>)</b>	
Lognormal Distribution	Use Equation 5-32 ID <sub>50</sub> = 15 CFU Probit slope = 3.50 probits/log(dose)
<b>Lethality (<math>p_f(\text{meli})</math>)</b>	
Untreated	
CFR	28%
Treated	
CFR	3%
<b>Incubation Period *</b>	
Lognormal Distribution	Mean = 4.8 days Standard deviation = 5.8 days
<b>Duration of Illness *</b>	
Stage 1: All Non-Survivors ( $F_U$ , $F_{T-WIA}$ , $F_{T-1}$ , $F_{T-2}$ ) Stage 1: Survivors, Untreated ( $S_U$ ) or Treatment Initiated in Stage 2 ( $S_{T-2}$ )	
PERT Distribution	Min = 1 day Max = 10 days Median = 3 days
Stage 2: All Non-Survivors ( $F_U$ , $F_{T-WIA}$ , $F_{T-1}$ and $F_{T-2}$ )	
PERT Distribution	Min = 0 days Max = 16 days Median = 3 days
Stage 2: Survivors, Untreated ( $S_U$ )	
PERT Distribution	Min = 1 day Max = 47 days Median = 15.5 days
Total Duration: Survivors, Treatment Initiated Upon Becoming WIA ( $S_{T-WIA}$ )	
Constant	14 days
Total Duration: Survivors, Treatment Initiated in Stage 1 or 2 ( $S_{T-1}$ , $S_{T-2}$ )	
Constant	14 days after $d_{\text{trt-meli}}$

\* Presented for information only. These two submodels have already been convolved to generate the PDTs; the user should use the PDTs to estimate when changes in casualty category occur.

**Table 5-42: Daily Fraction of Individuals III with Melioidosis (E) Who Become WIA\***

Day	Fraction	Day	Fraction	Day	Fraction	Day	Fraction	Day	Fraction
1	0.1192	9	0.0278	17	0.0053	25	0.0016	34–35	0.0005
2	0.2077	10	0.0218	18	0.0044	26	0.0014	36–37	0.0004
3	0.1647	11	0.0173	19	0.0038	27	0.0012	38–41	0.0003
4	0.1195	12	0.0138	20	0.0032	28	0.0011	42–46	0.0002
5	0.0865	13	0.0112	21	0.0028	29	0.0009	47–63	0.0001
6	0.0635	14	0.0092	22	0.0024	30	0.0008	≥64	0.0000
7	0.0474	15	0.0076	23	0.0021	31–32	0.0007		
8	0.0360	16	0.0063	24	0.0018	33	0.0006		

\* This equates to the time at which all cohorts enter Stage 1 (Severity Level 3).

**Table 5-43: Daily Fraction of Individuals III with Melioidosis (E\*) Who Enter Stage 2 of Illness†**

Day	Fraction <sup>§</sup>	Day	Fraction <sup>§</sup>	Day	Fraction <sup>§</sup>	Day	Fraction <sup>§</sup>	Day	Fraction <sup>§</sup>
1	0.0000	10	0.0692	19	0.0078	28	0.0018	38–39	0.0005
2	0.0026	11	0.0518	20	0.0065	29	0.0016	40–41	0.0004
3	0.0293	12	0.0390	21	0.0054	30	0.0014	42–45	0.0003
4	0.0746	13	0.0298	22	0.0045	31	0.0012	46–50	0.0002
5	0.1120	14	0.0231	23	0.0038	32	0.0011	51–65	0.0001
6	0.1296	15	0.0182	24	0.0033	33	0.0009	≥66	0.0000
7	0.1276	16	0.0145	25	0.0028	34	0.0008		
8	0.1121	17	0.0117	26	0.0024	35–36	0.0007		
9	0.0905	18	0.0095	27	0.0021	37	0.0006		

\* Exception: this table does not apply to Stage 1 Treated Melioidosis Survivors (S<sub>T-1</sub>), since their course of disease is interrupted by treatment that begins in Stage 1.

† Stage 2 is Injury Severity Level 2 for survivors (S cohorts other than S<sub>T-1</sub>), and Injury Severity Level 4 for non-survivors (all F cohorts).

§ For the S<sub>T-2</sub> cohort, the fractions are each divided by X<sub>norm</sub>, where  $X_{norm} = \sum_1^{d_{trt-meli}} PDT_{5-43}(d)$ . Accordingly, the fractions as applied to the S<sub>T-2</sub> cohort are also set to 0 for day > d<sub>trt-meli</sub>. This ensures that all of the S<sub>T-2</sub> cohort enters Stage 2 before d<sub>trt-meli</sub>.

**Table 5-44: Daily Fraction of Untreated or Treated Melioidosis Non-Survivors (F<sub>U</sub>, F<sub>T-WIA</sub>, F<sub>T-1</sub>, or F<sub>T-2</sub>) Who DOW**

Day	Fraction	Day	Fraction	Day	Fraction	Day	Fraction	Day	Fraction
≤2	0.0000	12	0.0873	22	0.0141	32	0.0022	42	0.0006
3	0.0007	13	0.0819	23	0.0112	33	0.0019	43–44	0.0005
4	0.0044	14	0.0739	24	0.0090	34	0.0016	45–46	0.0004
5	0.0135	15	0.0644	25	0.0074	35	0.0014	47–50	0.0003
6	0.0278	16	0.0544	26	0.0061	36	0.0013	51–55	0.0002
7	0.0449	17	0.0448	27	0.0050	37	0.0011	56–73	0.0001
8	0.0619	18	0.0361	28	0.0042	38	0.0010	≥74	0.0000
9	0.0759	19	0.0287	29	0.0035	39	0.0009		
10	0.0850	20	0.0226	30	0.0030	40	0.0008		
11	0.0886	21	0.0178	31	0.0026	41	0.0007		

**Table 5-45: Daily Fraction of Untreated Melioidosis Survivors (S<sub>U</sub>) Who Become RTD**

Day	Fraction	Day	Fraction	Day	Fraction	Day	Fraction	Day	Fraction
≤4	0.0000	17	0.0300	30	0.0349	43	0.0113	56	0.0011
5	0.0002	18	0.0324	31	0.0335	44	0.0097	57	0.0010

6	0.0006	19	0.0344	32	0.0318	45	0.0083	58	0.0008
7	0.0016	20	0.0360	33	0.0301	46	0.0070	59	0.0007
8	0.0032	21	0.0374	34	0.0282	47	0.0059	60–61	0.0006
9	0.0054	22	0.0383	35	0.0263	48	0.0049	62	0.0005
10	0.0081	23	0.0389	36	0.0243	49	0.0041	63–64	0.0004
11	0.0112	24	0.0392	37	0.0223	50	0.0033	65–67	0.0003
12	0.0145	25	0.0392	38	0.0204	51	0.0027	68–73	0.0002
13	0.0179	26	0.0388	39	0.0184	52	0.0023	74–86	0.0001
14	0.0212	27	0.0382	40	0.0165	53	0.0019	≥87	0.0000
15	0.0244	28	0.0373	41	0.0147	54	0.0016		
16	0.0273	29	0.0362	42	0.0129	55	0.0013		

**Table 5-46: Daily Fraction of Melioidosis Survivors Treated Upon Becoming WIA (S<sub>T-WIA</sub>) Who Become RTD\***

Day	Fraction	Day	Fraction	Day	Fraction	Day	Fraction
≤14	0.0000	24	0.0218 / X <sub>norm</sub>	34	0.0032 / X <sub>norm</sub>	44	0.0008 / X <sub>norm</sub>
15	0.1192 / X <sub>norm</sub>	25	0.0173 / X <sub>norm</sub>	35	0.0028 / X <sub>norm</sub>	45–46	0.0007 / X <sub>norm</sub>
16	0.2077 / X <sub>norm</sub>	26	0.0138 / X <sub>norm</sub>	36	0.0024 / X <sub>norm</sub>	47	0.0006 / X <sub>norm</sub>
17	0.1647 / X <sub>norm</sub>	27	0.0112 / X <sub>norm</sub>	37	0.0021 / X <sub>norm</sub>	48–49	0.0005 / X <sub>norm</sub>
18	0.1195 / X <sub>norm</sub>	28	0.0092 / X <sub>norm</sub>	38	0.0018 / X <sub>norm</sub>	50–51	0.0004 / X <sub>norm</sub>
19	0.0865 / X <sub>norm</sub>	29	0.0076 / X <sub>norm</sub>	39	0.0016 / X <sub>norm</sub>	52–55	0.0003 / X <sub>norm</sub>
20	0.0635 / X <sub>norm</sub>	30	0.0063 / X <sub>norm</sub>	40	0.0014 / X <sub>norm</sub>	56–60	0.0002 / X <sub>norm</sub>
21	0.0474 / X <sub>norm</sub>	31	0.0053 / X <sub>norm</sub>	41	0.0012 / X <sub>norm</sub>	61–75	0.0001 / X <sub>norm</sub>
22	0.0360 / X <sub>norm</sub>	32	0.0044 / X <sub>norm</sub>	42	0.0011 / X <sub>norm</sub>	≥78	0.0000
23	0.0278 / X <sub>norm</sub>	33	0.0038 / X <sub>norm</sub>	43	0.0009 / X <sub>norm</sub>		

\* This table is only used for day ≥ (14 + d<sub>trt-meli</sub>). Accordingly, X<sub>norm</sub> =  $\sum_{d_{trt-meli}}^{63} PDT_{5-42}(d)$ .

**Table 5-47: Daily Fraction of Stage 1 Treated Melioidosis Survivors (S<sub>T-1</sub>) and Stage 2 Treated Melioidosis Survivors (S<sub>T-2</sub>) Who Become RTD**

Day	Fraction
< 14 + d <sub>trt-meli</sub>	0.0000
14 + d <sub>trt-meli</sub>	1.0000
> 14 + d <sub>trt-meli</sub>	0.0000

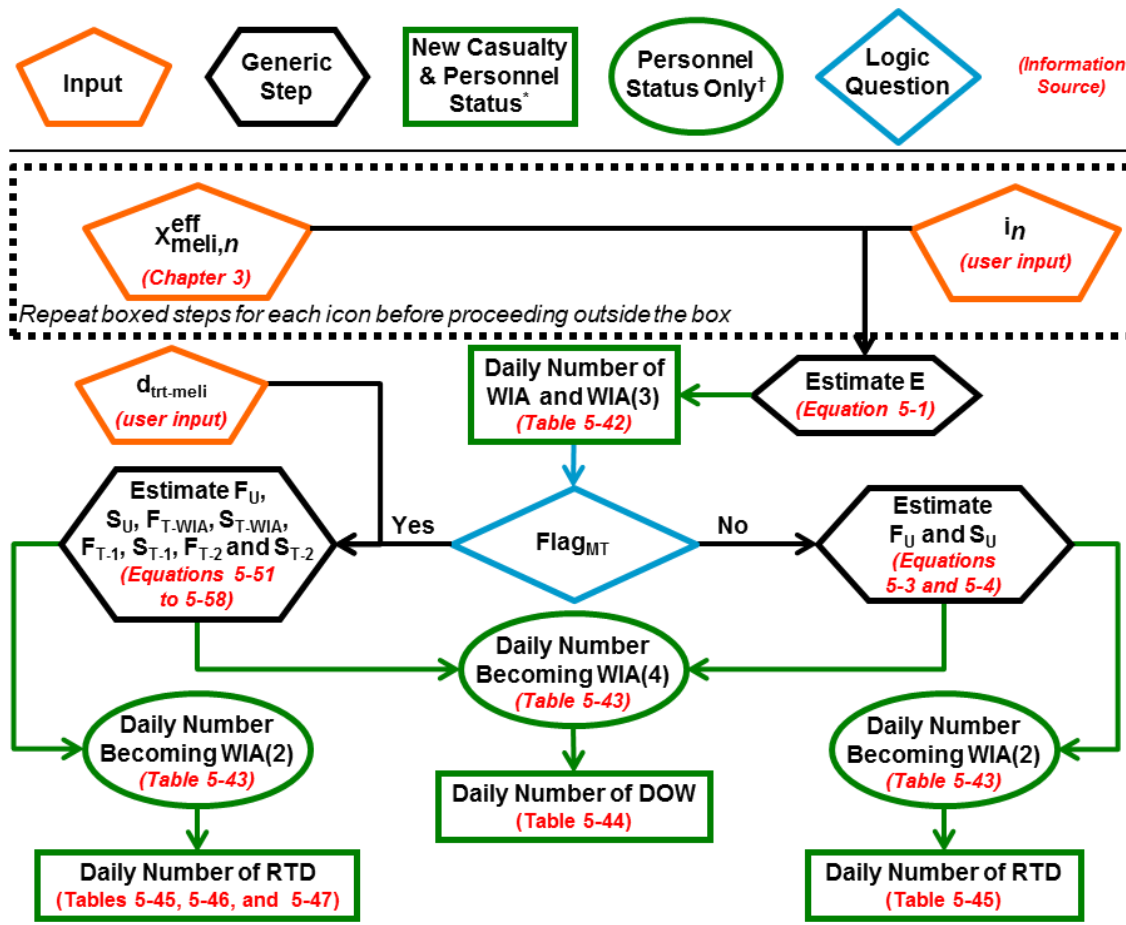

\* Casualty information (Pop<sub>cohort</sub>, CAT, table number) is passed to Equations 5-5 through 5-8.  
 † Personnel status information (Pop<sub>cohort</sub>, CAT, table number) is passed to Equation 5-7 and 5-8.

Figure 5-6: Human Response and Casualty Estimation for Melioidosis

5.2.5. Plague (isolation/quarantine model)<sup>86</sup>

1. Figure 5-7 summarizes the human response and casualty estimation processes for plague, Table 5-48 summarizes the Injury Profile, Table 5-50 summarizes the other plague submodels, and Table 5-49 summarizes the available plague prophylaxis options.
2. Assumptions and limitation.
  - a. Assumptions.
    - 1) The disease resulting from exposure to *Y. pestis* is pneumonic plague.
    - 2) Untreated pneumonic plague is 100% lethal.

<sup>86</sup> This section treats plague as a non-contagious disease to represent the potential planning assumption that isolation and quarantine will prevent significant spread of disease.

- b. Limitation. Although the model requires the user to specify a day on which antibiotic treatment becomes available ( $d_{\text{trt-plag}}$ ), it does *not* apply treatment to every person on that day; only those who have been declared WIA are modeled to begin receiving antibiotics on that day. Those who are declared WIA after  $d_{\text{trt-plag}}$  are modeled to begin receiving antibiotics on the day they are declared WIA.
3. Cohorts and special considerations.
- a. If  $\text{Flag}_{\text{MT}} = \text{No}$ , the population of the E cohort moves into  $F_U$ , and the  $S_U$  cohort does not exist because its population is always zero.
- b. If  $\text{Flag}_{\text{MT}} = \text{Yes}$  and the casualty criterion is WIA(1+) or WIA(2+), an individual's duration of illness and outcome depend upon the day on which antibiotic treatment becomes available. The user must specify the day on which antibiotic treatment becomes available for those declared WIA ( $d_{\text{trt-plag}}$ ); based on the specified value, the population of E is split among several sub-cohorts, as specified below.
- 1)  $F_U$  is the number of individuals who die before  $d_{\text{trt-plag}}$ .
  - 2)  $S_{\text{T-WIA}}$  is the number of individuals who are not yet WIA on  $d_{\text{trt-plag}}$ , but will become WIA later, will start antibiotic treatment on the first day they become WIA, and will survive and RTD.
  - 3)  $S_{\text{T-1}}$  is the number of individuals who are in Stage 1 on  $d_{\text{trt-plag}}$  that will survive and RTD as a result of antibiotic treatment.
  - 4)  $F_{\text{T-2}}$  is the number of individuals who are in Stage 2 on  $d_{\text{trt-plag}}$  that will die despite receiving antibiotic treatment.

$$F_U = E \cdot \sum_{d=1}^{d_{\text{trt-plag}}} \text{PDT}_{5-53}(d) \quad (5-59)$$

$$S_{\text{T-WIA}} = E \cdot \left( 1 - \sum_{d=1}^{d_{\text{trt-plag}}} \text{PDT}_{5-51}(d) \right) \quad (5-60)$$

$$S_{\text{T-1}} = E \cdot \text{PDT}_{5-51}(d_{\text{trt-plag}}) \quad (5-61)$$

$$F_{\text{T-2}} = E - (F_U + S_{\text{T-WIA}} + S_{\text{T-1}}) \quad (5-62)$$

In Equations 5-59 to 5-62:

$d_{\text{trt-plag}}$  is the user-specified day on which treatment begins, and

$PDT_{5-X}(d)$  reflect fractions of a specific population that have entered a certain stage of disease, as a function of a chosen day (d), as dictated by Table 5-X.

- c. If  $\text{Flag}_{\text{MT}} = \text{Yes}$  and the casualty criterion is  $\text{WIA}(3^+)$ , antibiotic treatment will be applied too late and will not save any lives or change the timing of DOWs. Thus, the E cohort moves into a generic F cohort (which includes those who die without receiving treatment and those who die despite receiving in Stage 2), according to Equation 5-3.

- 4. Table 5-51 through Table 5-55 are the PDTs for plague. The values from a given table are to be used in Equations 5-5 through 5-8 with the cohort(s) listed in the table headers and footers, per Figure 5-7.

**Table 5-48: Plague Injury Profile**

Stage	Injury Severity Level
Untreated ( $F_U$ ) and Treated ( $F_{T-2}$ ) Non-Survivors	
1	2
2	4
Treated Survivors ( $S_{T-WIA}, S_{T-1}$ )	
1	2
2	2

**Table 5-49: Plague Prophylaxis Summary**

Type of Prophylaxis	Efficacy ( $\rho_n$ )
Pre-exposure antibiotics	0.95
Post-exposure antibiotics	0.95

**Table 5-50: Plague Submodel Summary**

Type	Value
<b>Infectivity (<math>\rho_E(X_{\text{plag},n}^{\text{eff}})</math>)</b>	
Lognormal Distribution	Use Equation 5-32 $ID_{50} = 66 \text{ CFU}$ Probit slope = 1.8 probits/log(dose)
<b>Lethality (<math>\rho_f(\text{plag})</math>)</b>	
Untreated	
Treatment Initiated in Stage 2	
CFR	100%
Treatment Initiated in Stage 1	
CFR	0%
<b>Incubation Period*</b>	
Lognormal Distribution	Mean = 4.3 days Standard deviation = 1.8 days
<b>Duration of Illness*</b>	
Stage 1: All ( $F_U, S_{T-WIA}, S_{T-1},$ and $F_{T-2}$ )	
Constant	1 day
Stage 2: Non-Survivors, Untreated ( $F_U$ or $F$ )	

Type	Value
Stage 2: Non-Survivors, Treatment Initiated in Stage 2 ( $F_{T-2}$ or $F$ )	
Lognormal Distribution	Mean = 1.5 days Standard deviation = 1.2 days
Stage 2: Survivors, Treatment Initiated Upon Becoming WIA ( $S_{T-WIA}$ )	
Constant	10 days
Stage 2: Survivors, Treatment Initiated in Stage 1 ( $S_{T-1}$ )	
Constant	10 days after $d_{trt-plag}$

\* Presented for information only. These two submodels have already been convolved to generate the PDTs; the user should use the PDTs to estimate when changes in casualty category occur.

**Table 5-51: Daily Fraction of Individuals Ill with Plague (E) Who Become WIA, for Casualty Criterion WIA(1+) or WIA(2+)\***

Day	Fraction	Day	Fraction	Day	Fraction	Day	Fraction	Day	Fraction
1	0.0003	5	0.2094	9	0.0197	13	0.0014	17–20	0.0001
2	0.0439	6	0.1307	10	0.0100	14	0.0007	≥21	0.0000
3	0.1993	7	0.0728	11	0.0051	15	0.0004		
4	0.2648	8	0.0383	12	0.0026	16	0.0002		

\* This equates to the time at which all cohorts enter Stage 1 (Severity Level 2).

**Table 5-52: Daily Fraction of Individuals Ill with Plague (E) Who Become WIA, for Casualty Criterion WIA(3+)\***

Day	Fraction	Day	Fraction	Day	Fraction	Day	Fraction	Day	Fraction
1	0.0000	5	0.2648	9	0.0383	13	0.0026	17	0.0002
2	0.0003	6	0.2094	10	0.0197	14	0.0014	18–21	0.0001
3	0.0439	7	0.1307	11	0.0100	15	0.0007	≥22	0.0000
4	0.1993	8	0.0728	12	0.0051	16	0.0004		

\* This equates to the time at which all non-survivor cohorts ( $F_U$ ,  $F_{T-2}$ , and  $F$ ) enter Stage 2 (Severity Level 4).

**Table 5-53: Daily Fraction of Untreated or Treated Plague Non-Survivors ( $F_U$ ,  $F_{T-2}$ , or  $F$ ) Who DOW**

Day	Fraction	Day	Fraction	Day	Fraction	Day	Fraction	Day	Fraction
≤2	0.0000	7	0.2017	12	0.0198	17	0.0011	≥24	0.0000
3	0.0024	8	0.1511	13	0.0111	18	0.0007		
4	0.0446	9	0.0991	14	0.0062	19	0.0004		
5	0.1474	10	0.0602	15	0.0035	20	0.0002		
6	0.2133	11	0.0349	16	0.0020	21–23	0.0001		

**Table 5-54: Daily Fraction of Plague Survivors Treated Upon Becoming WIA ( $S_{T-WIA}$ ) Who Become RTD\***

Day	Fraction	Day	Fraction	Day	Fraction	Day	Fraction
≤10	0.0000	16	0.1307 / $X_{norm}$	22	0.0026 / $X_{norm}$	≥31	0.0000
11	0.0003 / $X_{norm}$	17	0.0728 / $X_{norm}$	23	0.0014 / $X_{norm}$		
12	0.0439 / $X_{norm}$	18	0.0383 / $X_{norm}$	24	0.0007 / $X_{norm}$		
13	0.1993 / $X_{norm}$	19	0.0197 / $X_{norm}$	25	0.0004 / $X_{norm}$		
14	0.2648 / $X_{norm}$	20	0.0100 / $X_{norm}$	26	0.0002 / $X_{norm}$		
15	0.2094 / $X_{norm}$	21	0.0051 / $X_{norm}$	27–30	0.0001 / $X_{norm}$		

\* This table is only used for day ≥ (10 +  $d_{trt-plag}$ ). Accordingly,  $X_{norm} = \sum_{d_{trt-plag}}^{20} PDT_{5-51}(d)$ .



**Table 5-55: Daily Fraction of Stage 1 Treated Plague Survivors ( $S_{T-1}$ ) Who Become RTD**

Day	Fraction
$< 10 + d_{\text{trt-plag}}$	0.0000
$10 + d_{\text{trt-plag}}$	1.0000
$> 10 + d_{\text{trt-plag}}$	0.0000

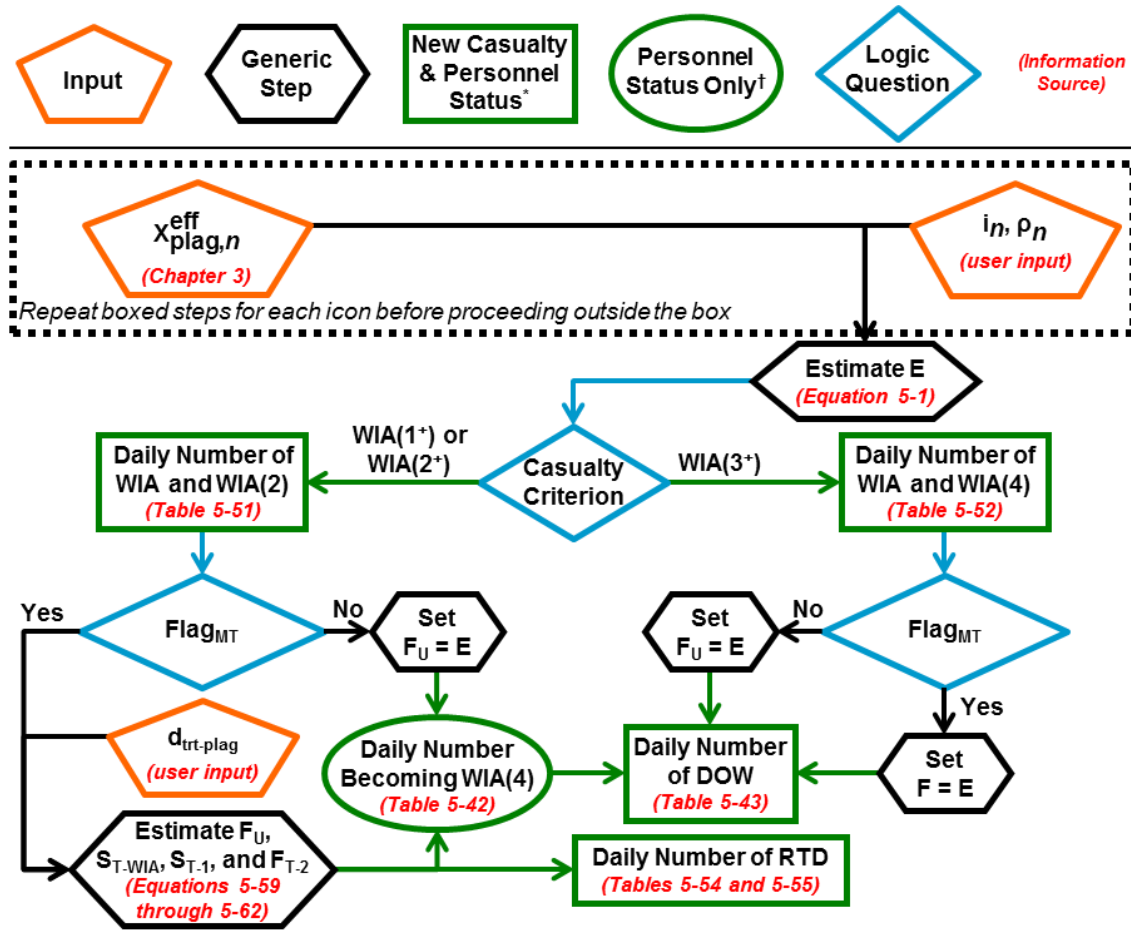

\* Casualty information (Pop<sub>cohort</sub>, CAT, table number) is passed to Equations 5-5 through 5-8.

† Personnel status information (Pop<sub>cohort</sub>, CAT, table number) is passed to Equation 5-7 and 5-8.

**Figure 5-7: Human Response and Casualty Estimation for Plague (isolation/quarantine model)**

### 5.2.6. Plague (contagious model)

1. The contagious plague model uses the same Injury Profile (Table 5-48), prophylaxis options (Table 5-49), infectivity model (Table 5-50), and lethality models (Table 5-50) as the isolation/quarantine model. However, the parameter values representing the incubation period and duration of illness models are different because of limitations in the SEIRP model. The SEIRP model also requires values for  $\alpha$  and  $\beta(d)$ . The values of the various parameters for plague in the SEIRP model are presented in Table 5-56.

2. Assumptions.
  - a. The disease resulting from exposure to *Y. pestis* is pneumonic plague.
  - b. Untreated pneumonic plague is 100% lethal.

**Table 5-56: SEIRP Model Parameter Values for Plague**

Parameter	Value
$\rho_E(X_{Q,n}^{eff})$	See Table 5-50
$\rho_S$	0.95
$\rho_E(d)$	0.95 for all d
$\mu_{E1}$	1 day
$\mu_{E2}$	3.3 days
$\mu_1$	1 day
$\mu_2$	1.5 days
$\mu_{RS}$	10 days
$\alpha$	0
$\beta(d)$	See Table 5-57
$MT_{I1}$	1
$\rho_f(d)$	See Table 5-50

**Table 5-57:  $\beta(d)$  Values for Plague<sup>87</sup>**

Day	$\beta(d)$	Day	$\beta(d)$	Day	$\beta(d)$	Day	$\beta(d)$	Day	$\beta(d)$
1	0	8	1.27051	15	1.751387	22	0.213678	29	0.34088
2	1.399368	9	2.046092	16	1.53121	23	0.129681	30	0.348683
3	2.114316	10	2.311747	17	1.120241	24	0.073931	31	0.239461
4	3.924383	11	2.272985	18	0.629848	25	0.190478	32	0.131417
5	4.323217	12	1.955047	19	0.375698	26	0.468109	33	0.016763
6	3.461722	13	1.639616	20	0.269083	27	0.554607	≥34	0
7	1.027207	14	1.723586	21	0.250477	28	0.44357		

### 5.2.7. Q Fever

1. Figure 5-8 summarizes the human response and casualty estimation processes for Q fever, Table 5-59 summarizes the Injury Profile, Table 5-61 summarizes the other Q fever submodels, and Table 5-60 summarizes the available Q fever prophylaxis options.
2. Assumption and limitation.
  - a. Assumption. Q fever does not cause any fatalities.
  - b. Limitation. Although the model requires the user to specify a day on which

<sup>87</sup> Derived from an outbreak in Mukden, China in 1946.

antibiotic treatment becomes available ( $d_{\text{trt-Qfvr}}$ ), it does *not* apply treatment to every person on that day; only those who have been declared WIA are modeled to begin receiving antibiotics on that day. Those who are declared WIA after  $d_{\text{trt-Qfvr}}$  are modeled to begin receiving antibiotics on the day they are declared WIA.

3. Cohorts and special considerations.
  - a. Q fever does not cause any fatalities, so no F cohorts are used, and the entire population of the E cohort is split among several possible S cohorts.
  - b. The Q fever incubation period model is dose-dependent; Table 5-58 summarizes the dose ranges. The E cohort is split into sub-cohorts labeled as  $E_{\text{DR}}$ , where DR is the dose range label given in Table 5-58. The population of each  $E_{\text{DR}}$  is calculated separately by applying Equation 5-1 to the appropriate range of doses.

**Table 5-58: Q Fever Dose Ranges**

Dose Range Label (DR)	Dose Range [organisms]		Dose Range Label (DR)	Dose Range [organisms]	
	$X_{\text{Qfvr},n}^{\text{eff}} >$	$X_{\text{Qfvr},n}^{\text{eff}} \leq$		$X_{\text{Qfvr},n}^{\text{eff}} >$	$X_{\text{Qfvr},n}^{\text{eff}} \leq$
A	0	2	K	127756	434808
B	2	7	L	434808	1479833
C	7	24	M	1479833	5036486
D	24	82	N	5036486	17141252
E	82	279	O	17141252	58338793
F	279	952	P	58338793	198551119
G	952	3240	Q	198551119	675751835
H	3240	11029	R	675751835	2299863853
I	11029	37537	S	2299863853	7827390868
J	37537	127756	T	7827390868	

- c. If  $\text{Flag}_{\text{MT}} = \text{No}$ , the  $E_{\text{DR}}$  sub-cohorts move into corresponding  $S_{\text{DR}}$  sub-cohorts.
- d. If  $\text{Flag}_{\text{MT}} = \text{Yes}$ , an individual's duration of illness depends upon the day on which antibiotic treatment becomes available. The user must specify the day on which antibiotic treatment becomes available for those declared WIA ( $d_{\text{trt-Qfvr}}$ ); based on the specified value, the population of the  $E_{\text{DR}}$  are split among several cohorts. Definitions of the cohorts and equations to calculate their populations are given below.
  - 1)  $S_{\text{DR,U}}$  is the number of individuals in dose range DR who recover and RTD before  $d_{\text{trt-Qfvr}}$ .
  - 2)  $S_{\text{DR,T-WIA}}$  is the number of individuals who are not yet WIA on  $d_{\text{trt-Qfvr}}$ , but will become WIA later, will start antibiotic treatment on the first day they become WIA, and will survive and RTD.
  - 3)  $S_{\text{DR,T}}$  is the number of individuals in dose range DR who are in Stage 1 on

$d_{\text{trt-Qfvr}}$  that will survive and RTD.

$$S_{\text{DR,U}} = E_{\text{DR}} \cdot \sum_{d=1+d_{\text{stg1,DR}}}^{d_{\text{trt-Qfvr}}} \text{PDT}_{5-63}(d) \tag{5-63}$$

$$S_{\text{DR,T-WIA}} = \begin{cases} E_{\text{DR}} & \text{if } d_{\text{trt-Qfvr}} < d_{\text{Stg1,DR}} \\ 0 & \text{if } d_{\text{trt-Qfvr}} \geq d_{\text{Stg1,DR}} \end{cases} \tag{5-64}$$

$$S_{\text{DR,T}} = \begin{cases} 0 & \text{if } d_{\text{trt-Qfvr}} < d_{\text{Stg1,DR}} \\ (E_{\text{DR}} - S_{\text{DR,U}}) & \text{if } d_{\text{trt-Qfvr}} \geq d_{\text{Stg1,DR}} \end{cases} \tag{5-65}$$

In Equations 5-63 to 5-65:

$d_{\text{trt-Qfvr}}$  is the user-specified day on which treatment begins,

$d_{\text{Stg1,DR}}$  is the day on which all individuals in dose range DR ( $E_{\text{DR}}$ ) enter Stage 1 (see Table 5-62), and

$\text{PDT}_{5-X}(d)$  reflect fractions of a specific population that have entered a certain stage of disease, as a function of a chosen day (d), as dictated by Table 5-X.

- Table 5-62 through Table 5-65 are the PDTs for Q fever. The values from a given table are to be used in Equations 5-5 through 5-8 with the cohort(s) listed in the table headers and footers, per Figure 5-8.

**Table 5-59: Q Fever Injury Profile**

Stage	Injury Severity Level
1	2

**Table 5-60: Q Fever Prophylaxis Summary**

Type of Prophylaxis	Efficacy ( $\rho_n$ )
Pre-exposure vaccination <sup>88</sup>	1.00

**Table 5-61: Q Fever Submodel Summary**

Type	Value
<b>Infectivity (<math>\rho_E(X_{\text{Qfvr},n}^{\text{eff}})</math>)</b>	
Lognormal Distribution	Use Equation 5-32 ID <sub>50</sub> = 30 organisms Probit slope = 0.782 probits/log(dose)
<b>Lethality (<math>\rho_f(\text{Qfvr})</math>)</b>	
CFR	0%
<b>Incubation Period*</b>	
Log-linear function	Dose-dependent: 1–20 days m = -1.88 days/log(dose), b = 19.6 days

<sup>88</sup> Note that not all NATO nations have a Q Fever vaccine.

Type	Value
<b>Duration of Illness*</b>	
Stage 1: Survivor, Untreated ( $S_{DR,U}$ )	
Lognormal Distribution	Mean = 12.1 days Standard deviation = 6.66 days
Stage 1: Survivors, Treatment Initiated Upon Becoming WIA ( $S_{DR,T-WIA}$ )	
Constant	5 days
Stage 1: Survivor, Treatment Initiated in Stage 1 ( $S_{DR,T}$ )	
Constant	5 days after $d_{trt-Qfvr}$

\* Presented for information only. These two submodels have already been convolved to generate the PDTs; the user should use the PDTs to estimate when changes in casualty category occur.

**Table 5-62: Dose-Dependent Day on Which Individuals Ill with Q Fever ( $E_{DR}$ ) Become WIA, for Casualty Criterion WIA(1+) or WIA(2+)\***

Day†	Dose Range	Day†	Dose Range	Day†	Dose Range	Day†	Dose Range
20	A	15	F	10	K	5	P
19	B	14	G	9	L	4	Q
18	C	13	H	8	M	3	R
17	D	12	I	7	N	2	S
16	E	11	J	6	O	1	T

\* This equates to the time at which all cohorts enter Stage 1 (Severity Level 2).

† Elsewhere in the Q fever section, this day is referred to as  $d_{Stg1,DR}$ .

**Table 5-63: Daily Fraction of Untreated Q Fever Survivors in Dose Range DR ( $S_{DR,U}$ ) who Become RTD\***

Day†	Fraction	Day†	Fraction	Day†	Fraction	Day†	Fraction
$\leq 1+d_{stg1,DR}$	0.0000	$13+d_{stg1,DR}$	0.0590	$25+d_{stg1,DR}$	0.0084	$37+d_{stg1,DR}$	0.0012
$2+d_{stg1,DR}$	0.0006	$14+d_{stg1,DR}$	0.0515	$26+d_{stg1,DR}$	0.0071	$38+d_{stg1,DR}$	0.0010
$3+d_{stg1,DR}$	0.0065	$15+d_{stg1,DR}$	0.0445	$27+d_{stg1,DR}$	0.0060	$39+d_{stg1,DR}$	0.0009
$4+d_{stg1,DR}$	0.0220	$16+d_{stg1,DR}$	0.0381	$28+d_{stg1,DR}$	0.0051	$40+d_{stg1,DR}$	0.0007
$5+d_{stg1,DR}$	0.0430	$17+d_{stg1,DR}$	0.0325	$29+d_{stg1,DR}$	0.0043	$(41-42)+d_{stg1,DR}$	0.0006
$6+d_{stg1,DR}$	0.0623	$18+d_{stg1,DR}$	0.0276	$30+d_{stg1,DR}$	0.0036	$43+d_{stg1,DR}$	0.0005
$7+d_{stg1,DR}$	0.0757	$19+d_{stg1,DR}$	0.0234	$31+d_{stg1,DR}$	0.0031	$(44-45)+d_{stg1,DR}$	0.0004
$8+d_{stg1,DR}$	0.0822	$20+d_{stg1,DR}$	0.0197	$32+d_{stg1,DR}$	0.0026	$(46-47)+d_{stg1,DR}$	0.0003
$9+d_{stg1,DR}$	0.0831	$21+d_{stg1,DR}$	0.0166	$33+d_{stg1,DR}$	0.0022	$(48-51)+d_{stg1,DR}$	0.0002
$10+d_{stg1,DR}$	0.0797	$22+d_{stg1,DR}$	0.0140	$34+d_{stg1,DR}$	0.0019	$(52-59)+d_{stg1,DR}$	0.0001
$11+d_{stg1,DR}$	0.0738	$23+d_{stg1,DR}$	0.0118	$35+d_{stg1,DR}$	0.0016	$\geq 60+d_{stg1,DR}$	0.0000
$12+d_{stg1,DR}$	0.0666	$24+d_{stg1,DR}$	0.0100	$36+d_{stg1,DR}$	0.0014		

\* This table must be applied individually for each dose range because the value of  $d_{Stg1,DR}$  is different for each dose range.

† Where  $d_{Stg1,DR}$  is the day on which the casualty entered Stage 1, according to Table 5-62.

**Table 5-64: Dose-Dependent Day on Which Q Fever Survivors Treated Upon Becoming WIA ( $S_{DR,T-WIA}$ ) Become RTD**

Day	Dose Range	Day	Dose Range	Day	Dose Range	Day	Dose Range
25	A	20	F	15	K	10	P
24	B	19	G	14	L	9	Q
23	C	18	H	13	M	8	R
22	D	17	I	12	N	7	S
21	E	16	J	11	O	6	T

\* This table is only used for day  $\geq (5 + d_{trt-Qfvr})$ .

**Table 5-65: Daily Fraction of Stage 1 Treated Q Fever Survivors ( $S_{DR,T}$ ) Who Become RTD**

Day	Fraction
$< 5 + d_{trt-Qfvr}$	0.0000
$5 + d_{trt-Qfvr}$	1.0000
$> 5 + d_{trt-Qfvr}$	0.0000

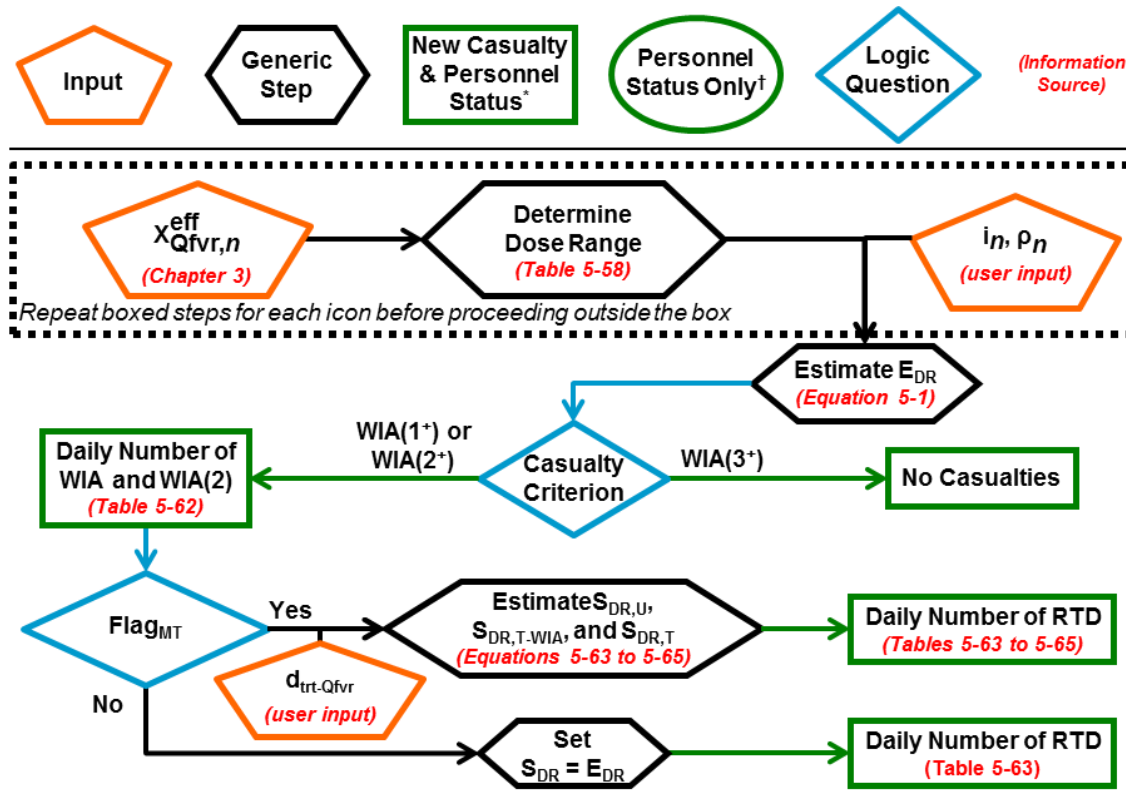

\* Casualty information ( $Pop_{cohort}$ , CAT, table number) is passed to Equations 5-5 through 5-8.  
 † Personnel status information ( $Pop_{cohort}$ , CAT, table number) is passed to Equation 5-7 and 5-8.

**Figure 5-8: Human Response and Casualty Estimation for Q Fever**

**5.2.8. Tularemia**

1. Figure 5-9 summarizes the human response and casualty estimation processes for tularemia, Table 5-67 summarizes the Injury Profile, and Table 5-69 summarizes the other tularemia submodels. No prophylaxis is modeled for tularemia.
2. Assumption and limitation.
  - a. Assumption. Inhalation of *F. tularensis* results in typhoidal tularemia with pneumonia.
  - b. Limitation. Although the model requires the user to specify a day on which antibiotic treatment becomes available ( $d_{trt-tul}$ ), it does *not* apply treatment to every person on that day; only those who have been declared WIA are

modeled to begin receiving antibiotics on that day. Those who are declared WIA after  $d_{\text{trt-tul}}$  are modeled to begin receiving antibiotics on the day they are declared WIA.

3. Cohorts and special considerations.
  - a. The tularemia incubation period model is dose-dependent; Table 5-66 summarizes the dose ranges. The population of each  $E_{\text{DR}}$  is calculated by applying Equation 5-1 to icons with the appropriate range of doses.

**Table 5-66: Tularemia Dose Ranges**

Dose Range Label (DR)	Dose Range [organisms]	
	$X_{\text{tul},n}^{\text{eff}} >$	$X_{\text{tul},n}^{\text{eff}} \leq$
A	0	4
B	4	75
C	75	1241
D	1241	20502
E	20502	421696
F	421696	

- b. If  $\text{Flag}_{\text{MT}} = \text{No}$ , the populations of the  $E_{\text{DR}}$  cohorts move into  $F_{\text{DR,U}}$  and  $S_{\text{DR,U}}$ , per Equations 5-3 and 5-4. Each equation is used once per dose range.
- c. If  $\text{Flag}_{\text{MT}} = \text{Yes}$ , the population of the  $E_{\text{DR}}$  and an individual's outcome and duration of illness depend upon the day on which antibiotic treatment becomes available. The user must specify the day on which antibiotic treatment becomes available for those declared WIA ( $d_{\text{trt-tul}}$ ); based on the specified value, the population of the  $E_{\text{DR}}$  are split among several cohorts. Definitions of the cohorts and equations to calculate their populations are given below.
  - 1)  $F_{\text{DR,U}}$  is the number of individuals in dose range DR who die before  $d_{\text{trt-tul}}$ .
  - 2)  $S_{\text{DR,U}}$  is the number of individuals in dose range DR who recover and RTD before  $d_{\text{trt-tul}}$ .
  - 3)  $S_{\text{DR,T-WIA}}$  is the number of individuals who are not yet WIA on  $d_{\text{trt-tul}}$ , but will become WIA later, will start antibiotic treatment on the first day they become WIA, and will survive and RTD.
  - 4)  $S_{\text{DR,T-1}}$  is the number of individuals in dose range DR who are in Stage 1 on  $d_{\text{trt-tul}}$ ; they will survive and RTD.
  - 5)  $S_{\text{DR,T-2}}$  is the number of individuals in dose range DR who are in Stage 2 on  $d_{\text{trt-tul}}$ ; they will survive and RTD.
  - 6)  $S_{\text{DR,T-3}}$  is the number of individuals in dose range DR who are in Stage 3 on  $d_{\text{trt-tul}}$ ; they will survive and RTD.

$$F_{DR,U} = \begin{cases} 0 & \text{if } d_{trt-tul} < d_{DOW,DR} \\ (E_{DR} \cdot p_{f,U}) & \text{if } d_{trt-tul} \geq d_{DOW,DR} \end{cases} \quad (5-66)$$

$$S_{DR,U} = \begin{cases} 0 & \text{if } d_{trt-tul} < d_{RTD,DR} \\ (E_{DR} - F_{DR,U}) & \text{if } d_{trt-tul} \geq d_{RTD,DR} \end{cases} \quad (5-67)$$

$$S_{DR,T-WIA} = \begin{cases} E_{DR} & \text{if } d_{trt-tul} < d_{Stg1,DR} \\ 0 & \text{if } d_{trt-tul} \geq d_{Stg1,DR} \end{cases} \quad (5-68)$$

$$S_{DR,T-1} = \begin{cases} E_{DR} & \text{if } d_{Stg1,DR} \leq d_{trt-tul} < d_{Stg2,DR} \\ 0 & \text{if } d_{trt-tul} \geq d_{Stg2,DR} \end{cases} \quad (5-69)$$

$$S_{DR,T-2} = \begin{cases} (E_{DR} - F_{DR,U}) & \text{if } d_{Stg2,DR} \leq d_{trt-tul} < d_{Stg3,DR} \\ 0 & \text{if } d_{trt-tul} \geq d_{Stg3,DR} \end{cases} \quad (5-70)$$

$$S_{DR,T-3} = \begin{cases} (E_{DR} - F_{DR,U}) & \text{if } d_{Stg3,DR} \leq d_{trt-tul} < d_{RTD,DR} \\ 0 & \text{if } d_{trt-tul} \geq d_{RTD,DR} \end{cases} \quad (5-71)$$

In Equations 5-66 to 5-71:

$d_{trt-tul}$  is the user-specified day on which treatment begins,

$d_{DOW,DR}$  is the day on which all untreated non-survivors in dose range DR ( $F_{DR,U}$ ) DOW,

$d_{RTD,DR}$  is the day on which all untreated survivors in dose range DR ( $S_{DR,U}$ ) become RTD,

$d_{Stg1,DR}$  is the day on which all individuals in dose range DR ( $E_{DR}$ ) enter Stage 1,

$d_{Stg2,DR}$  is the day on which all untreated (or not-yet-treated) survivors in dose range DR enter Stage 2, and

$d_{Stg3,DR}$  is the day on which all untreated (or not-yet-treated) survivors in dose range DR enter Stage 3.

4. Table 5-70 through Table 5-74 are the PDTs for tularemia. The values from a given table are to be used in Equations 5-5 through 5-8 with the cohort(s) listed in the table headers and footers, per Figure 5-9.

**Table 5-67: Tularemia Injury Profile**

Stage	Injury Severity Level
Untreated Non-Survivors ( $F_{DR,U}$ )	
1	3
2	4
All Survivors ( $S_{DR,U}$ , $S_{DR,T-WIA}$ , $S_{DR,T-1}$ , $S_{DR,T-2}$ , $S_{DR,T-3}$ )	



Stage	Injury Severity Level
1	3
2	3
3	2

**Table 5-68: Tularemia Prophylaxis Summary**

Type of Prophylaxis	Efficacy ( $\rho_n$ )
Post-exposure antibiotics	1.00

**Table 5-69: Tularemia Submodel Summary**

Type	Value
<b>Infectivity (<math>\rho_E(X_{tul,n}^{eff})</math>)</b>	
Lognormal Distribution	Use Equation 5-32 ID <sub>50</sub> = 10 organisms Probit slope = 1.90 probits/log(dose)
<b>Lethality (<math>\rho_f(tul)</math>)</b>	
Untreated	
CFR	75%
Treated	
CFR	0%
<b>Incubation Period*</b>	
For $X_{tul,n}^{eff} < 106,604$ organisms	
Log-linear Function	Dose-dependent: range 3–7 days $m = -0.8207$ days/log(dose) $b = 6.538$ days
For $106,604$ organisms $\leq X_{tul,n}^{eff} < 9,019,577$ organisms	
Log-quadratic Function	Dose-dependent: range 2–3 days $a = 0.1763$ days/(log(dose)) <sup>2</sup> $b = -2.589$ days/log(dose) $c = 10.96$ days
For $X_{tul,n}^{eff} \geq 9,019,577$ organisms	
Constant	1.5 days
<b>Duration of Illness*</b>	
Stage 1: Non-survivors, Untreated ( $F_{DR,U}$ )	
Constant	9 days
Stage 2: Non-survivors, Untreated ( $F_{DR,U}$ )	
Constant	6 days
Stage 1: Survivors, Untreated ( $S_{DR,U}$ )	
Constant	12 days
Stage 2: Survivors, Untreated ( $S_{DR,U}$ )	
Constant	28 days
Stage 3: Survivors, Untreated ( $S_{DR,U}$ )	
Constant	84 days
Total Duration: Survivors, Treatment Initiated Upon Becoming WIA ( $S_{DR,T-WIA}$ )	
Constant	10 days
Total Duration: Survivors, Treatment Initiated in Stage 1, 2, or 3 ( $S_{DR,T-1}$ , $S_{DR,T-2}$ , $S_{DR,T-3}$ )	
Constant	10 days after $d_{trt-tul}$

\* Presented for information only. These two submodels have already been convolved to generate the PDTs; the user should use the PDTs to estimate when changes in casualty category occur.

**Table 5-70: Dose-Dependent Day on Which Individuals Ill with Tularemia ( $E_{DR}$ ) Become WIA, for Any Casualty Criterion\***

Day <sup>†</sup>	Dose Range	Day <sup>†</sup>	Dose Range	Day <sup>†</sup>	Dose Range	Day <sup>†</sup>	Dose Range
≥8	(none)	6	B	4	D	2	F
7	A	5	C	3	E	1	(none)

\* This equates to the time at which all cohorts enter Stage 1 (Severity Level 3).

† Elsewhere in the tularemia section, this day is referred to as  $d_{Stg1,DR}$ .

**Table 5-71: Dose-Dependent Day on Which Tularemia Non-Survivors ( $F_{DR,U}$ ) Enter Stage 2 of Illness**

Day*	Dose Range	Day*	Dose Range	Day*	Dose Range	Day*	Dose Range
≥17	(none)	15	B	13	D	11	F
16	A	14	C	12	E	≤10	(none)

\* Elsewhere in the tularemia section, this day is referred to as  $d_{Stg2,DR}$ .

**Table 5-72: Dose-Dependent Day on Which Untreated Tularemia Non-Survivors ( $F_{DR,U}$ ) DOW**

Day*	Dose Range	Day*	Dose Range	Day*	Dose Range	Day*	Dose Range
≥23	(none)	21	B	19	D	17	F
22	A	20	C	18	E	≤16	(none)

\* Elsewhere in the tularemia section, this day is referred to as  $d_{DOW,DR}$ .

**Table 5-73: Dose-Dependent Day on Which Tularemia Survivors ( $S_{DR,U}$ ,  $S_{DR,T-3}$ ) Enter Stage 3 of Illness**

Day*	Dose Range	Day*	Dose Range	Day*	Dose Range	Day*	Dose Range
≥48	(none)	46	B	44	D	42	F
47	A	45	C	43	E	≤41	(none)

\* Elsewhere in the tularemia section, this day is referred to as  $d_{Stg3,DR}$ .

**Table 5-74: Dose-Dependent Day on Which Untreated Tularemia Survivors ( $S_{DR,U}$ ) Become RTD**

Day*	Dose Range	Day*	Dose Range	Day*	Dose Range	Day*	Dose Range
≥132	(none)	130	B	128	D	126	F
131	A	129	C	127	E	≤125	(none)

\* Elsewhere in the tularemia section, this day is referred to as  $d_{RTD,DR}$ .

**Table 5-75: Dose-Dependent Day on Which Tularemia Survivors Treated Upon Becoming WIA ( $S_{DR,T-WIA}$ ) Become RTD\***

Day	Dose Range	Day	Dose Range	Day	Dose Range	Day	Dose Range
≥18	(none)	16	B	14	D	12	F
17	A	15	C	13	E	≤11	(none)

\* This table is only used for day  $\geq (10 + d_{trt-tul})$ .

**Table 5-76: Daily Fraction of Stage 1, 2, or 3 Treated Tularemia Survivors ( $S_{DR,T-1}$ ,  $S_{DR,T-2}$ ,  $S_{DR,T-3}$ ) Who Become RTD**

Day	Fraction
$< 10 + d_{trt-tul}$	0.0000
$10 + d_{trt-tul}$	1.0000
$> 10 + d_{trt-tul}$	0.0000

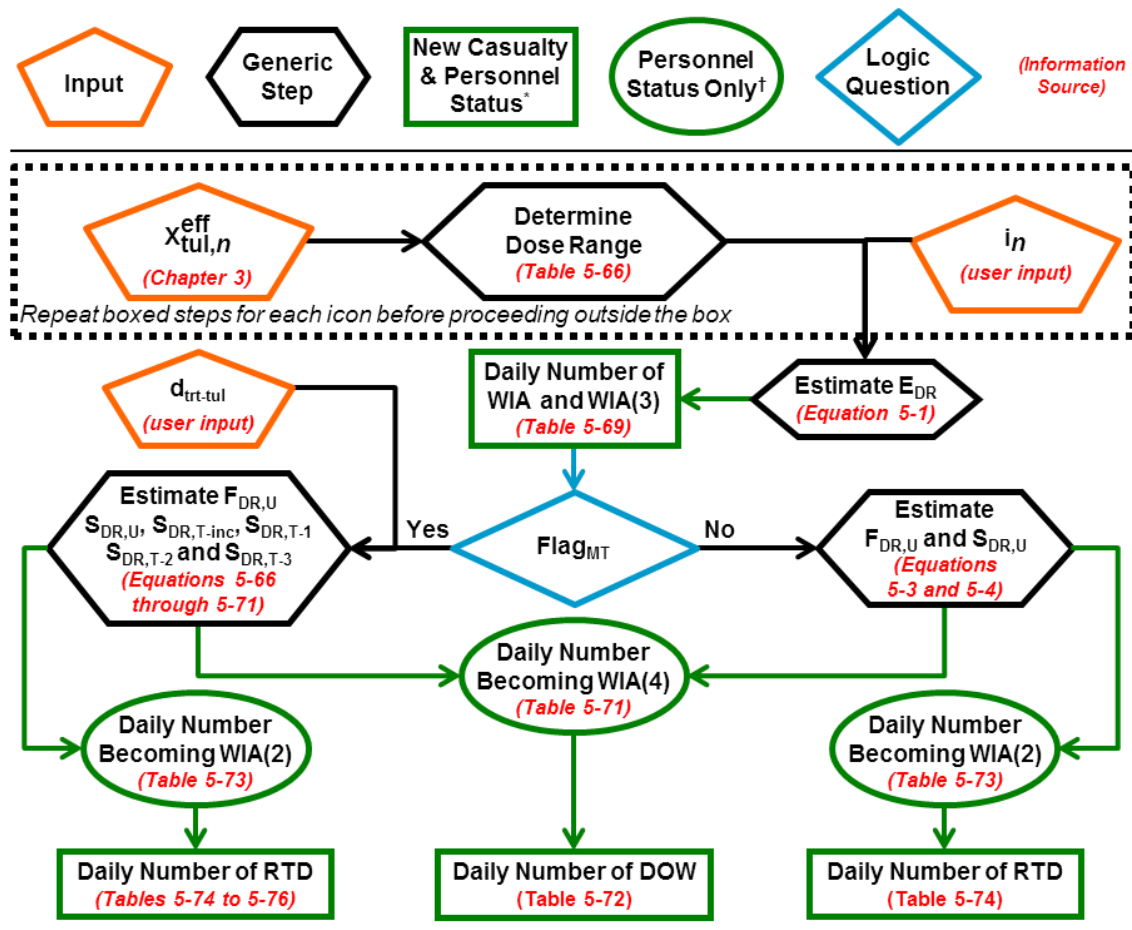

\* Casualty information (Pop<sub>cohort</sub>, CAT, table number) is passed to Equations 5-5 through 5-8.  
 † Personnel status information (Pop<sub>cohort</sub>, CAT, table number) is passed to Equation 5-7 and 5-8.

**Figure 5-9: Human Response and Casualty Estimation for Tularemia**

**5.2.9. Smallpox (isolation/quarantine model)<sup>89</sup>**

1. Figure 5-10 summarizes the human response and casualty estimation processes for smallpox, Table 5-77 summarizes the Injury Profile, Table 5-79 summarizes the other smallpox submodels, and Table 5-78 summarizes the available smallpox prophylaxis options.

2. Assumptions.

- a. Inhalation of *V. major* results in “ordinary-type” (discrete) smallpox.
- b. Vaccination of all personnel is performed on the same day— $d_{vac-spox}$ .
- c. Personnel receiving post-exposure vaccination have no history of smallpox

<sup>89</sup> This section treats smallpox as a non-contagious disease to represent the potential planning assumption that isolation and quarantine will prevent significant spread of disease.

vaccination.

3. Cohorts and special considerations.
  - a. Medical treatment has no effect on the submodel parameter values.
  - b. The lethality model is different for the unvaccinated population and the population that was vaccinated but did not gain immunity. Since post-exposure, pre-symptom onset vaccination is relevant (in addition to pre-exposure prophylaxis), the user must specify ( $d_{\text{vac-spox}}$ ). To model pre-exposure vaccination, the day should be set to 0. When
    - 1) If  $d_{\text{vac-spox}} \leq 6$ , the population of  $E_U$  is 0 and the population of  $E_V$  is calculated according to Equation 5-1, with the value of  $\rho_n$  determined according to Table 5-78.
      - a) If  $d_{\text{vac-spox}} = 0$ , the populations of  $F_V$  and  $S_V$  are calculated according to Equations 5-3 and 5-4 and using  $p_{\text{f-prevax}}(\text{spox})$  from Table 5-79.
      - b) If  $d_{\text{vac-spox}} > 0$ , the populations of  $F_V$  and  $S_V$  are calculated according to Equations 5-3 and 5-4 and using  $p_{\text{f-postvax}}(\text{spox})$  from Table 5-79.
    - 2) If  $d_{\text{vac-spox}} \geq 7$ , any individual who has already become ill by  $d_{\text{vac-spox}}$  will be in  $E_U$  and the remainder of the ill will be in  $E_V$ ; the cohort populations must be calculated according to Equations 5-72 and 5-73. Then, the population of the  $E_U$  cohort moves into  $F_U$  and  $S_U$  based on Equations 5-3 and 5-4 and  $p_{\text{f-unvax}}(\text{spox})$  from Table 5-79, and the population of the  $E_V$  cohort moves into  $F_V$  and  $S_V$  based on Equations 5-3 and 5-4 and  $p_{\text{f-postvax}}(\text{spox})$  from Table 5-79.

$$E_U = \sum_n (i_n \cdot p_E(X_{\text{spox},n}^{\text{eff}})) \cdot \sum_{d=7}^{d_{\text{vac-spox}}} \text{PDT}_{5-79}(d) \quad (5-72)$$

$$E_V = \sum_n (i_n \cdot (1 - \rho_n(d)) \cdot p_E(X_{\text{spox},n}^{\text{eff}})) \cdot \left( 1 - \sum_{d=7}^{d_{\text{vac-spox}}} \text{PDT}_{5-79}(d) \right) \quad (5-73)$$

In Equations 5-72 to 5-73:

$i_n$  is the population of icon  $n$ ,

$\rho_n(d)$  is the efficacy of prophylaxis in preventing illness, per Table 5-78,

$\rho_E(X_{\text{spx},n}^{\text{eff}})$  is the probability that icon  $n$  will become ill, as calculated by Equation 5-33 with the parameter from Table 5-79,

$d_{\text{vac-spx}}$  is the user-specified day on which vaccination occurs, and

$\text{PDT}_{5-X}(d)$  reflect fractions of a specific population that have entered a certain stage of disease, as a function of a chosen day ( $d$ ), as dictated by Table 5-X.

4. Table 5-80 through Table 5-83 are the PDTs for smallpox. The values from a given table are to be used in Equations 5-5 through 5-8 with the cohort(s) listed in the table headers and footers, per Figure 5-10.

**Table 5-77: Smallpox Injury Profile**

Stage	Injury Severity Level
Non-survivors ( $F_U$ and $F_V$ )	
1	2
2	4
Survivors ( $S_U$ and $S_V$ )	
1	2
2	3
CONV	CONV

**Table 5-78: Smallpox Prophylaxis Summary**

Type of Prophylaxis	$d_{\text{vac-spx}}$	Efficacy ( $\rho_n$ )
Pre-exposure vaccination	0	0.95
Post-exposure vaccination	1	0.90
Post-exposure vaccination	2-4	0.80
Post-exposure vaccination	5-8	0.25
Post-exposure vaccination	9-15	0.02
Post-exposure vaccination	$\geq 16$	0.00

**Table 5-79: Smallpox Submodel Summary**

Type	Value
<b>Infectivity (<math>\rho_E(X_{\text{spx},n}^{\text{eff}})</math>)</b>	
Threshold	Use Equation 5-33 10 PFU
<b>Lethality</b>	
Unvaccinated ( $\rho_{f\text{-unvax}}(\text{spx})$ ) – applies when $d_{\text{vac-spx}} > 0$	
CFR	30%
Vaccinated Pre-Exposure ( $\rho_{f\text{-prevax}}(\text{spx})$ ) – applies when $d_{\text{vac-spx}} = 0$	
CFR	3%
Vaccinated Post-Exposure ( $\rho_{f\text{-postvax}}(\text{spx})$ ) – applies when $d_{\text{vac-spx}} > 0$	
CFR	20%
<b>Incubation Period*</b>	
Lognormal Distribution	Mean = 11.6 days Standard deviation = 1.8 days

Type	Value
<b>Duration of Illness*</b>	
Stage 1: Unvaccinated and Vaccinated ( $E_U$ and $E_V$ )	
Lognormal Distribution	Mean = 3.0 days Standard deviation = 0.95 days
Stage 2: Unvaccinated and Vaccinated ( $F_U$ , $F_V$ , $S_U$ , and $S_V$ )	
Lognormal Distribution	Mean = 14.0 days Standard deviation = 2.24 days
CONV: Survivors, Unvaccinated and Vaccinated ( $S_U$ and $S_V$ )	
Constant	5 days

\* Presented for information only. These two submodels have already been convolved to generate the PDTs; the user should use the PDTs to estimate when changes in casualty category occur.

**Table 5-80: Daily Fraction of Individuals Ill with Smallpox ( $E_U$  and  $E_V$ ) Who Become WIA, for Casualty Criterion WIA(1+) or WIA(2+)\***

Day	Fraction	Day	Fraction	Day	Fraction	Day	Fraction	Day	Fraction
≤6	0.0000	10	0.1296	14	0.1099	18	0.0036	≥22	0.0000
7	0.0007	11	0.2066	15	0.0568	19	0.0012		
8	0.0092	12	0.2220	16	0.0253	20	0.0004		
9	0.0486	13	0.1760	17	0.0100	21	0.0001		

\* This equates to the time at which all cohorts enter Stage 1 (Severity Level 2).

**Table 5-81: Daily Fraction of Individuals Ill with Smallpox ( $E_U$  and  $E_V$ ) Who Become WIA, for Casualty Criterion WIA(3+)\***

Day	Fraction	Day	Fraction	Day	Fraction	Day	Fraction	Day	Fraction
≤8	0.0000	12	0.0648	16	0.1631	20	0.0149	24	0.0003
9	0.0003	13	0.1318	17	0.1113	21	0.0062	25	0.0001
10	0.0035	14	0.1864	18	0.0646	22	0.0024	≥26	0.0000
11	0.0202	15	0.1965	19	0.0328	23	0.0008		

\* This equates to the time at which all cohorts enter Stage 2 (Severity Level 4 for non-survivors, and Severity Level 3 for survivors).

**Table 5-82: Daily Fraction of Smallpox Non-Survivors ( $F_U$  and  $F_V$ ) Who DOW and Smallpox Survivors Who Become CONV**

Day	Fraction	Day	Fraction	Day	Fraction	Day	Fraction	Day	Fraction
≤18	0.0000	24	0.0315	30	0.1204	36	0.0119	42	0.0002
19	0.0001	25	0.0568	31	0.0995	37	0.0065	43	0.0001
20	0.0003	26	0.0866	32	0.0753	38	0.0034	≥44	0.0000
21	0.0015	27	0.1135	33	0.0526	39	0.0017		
22	0.0053	28	0.1301	34	0.0342	40	0.0008		
23	0.0144	29	0.1321	35	0.0208	41	0.0004		

**Table 5-83: Daily Fraction of Smallpox Survivors ( $S_U$  and  $S_V$ ) Who Become RTD**

Day	Fraction	Day	Fraction	Day	Fraction	Day	Fraction	Day	Fraction
≤23	0.0000	29	0.0315	35	0.1204	41	0.0119	47	0.0002
24	0.0001	30	0.0568	36	0.0995	42	0.0065	48	0.0001
25	0.0003	31	0.0866	37	0.0753	43	0.0034	≥49	0.0000
26	0.0015	32	0.1135	38	0.0526	44	0.0017		
27	0.0053	33	0.1301	39	0.0342	45	0.0008		
28	0.0144	34	0.1321	40	0.0208	46	0.0004		

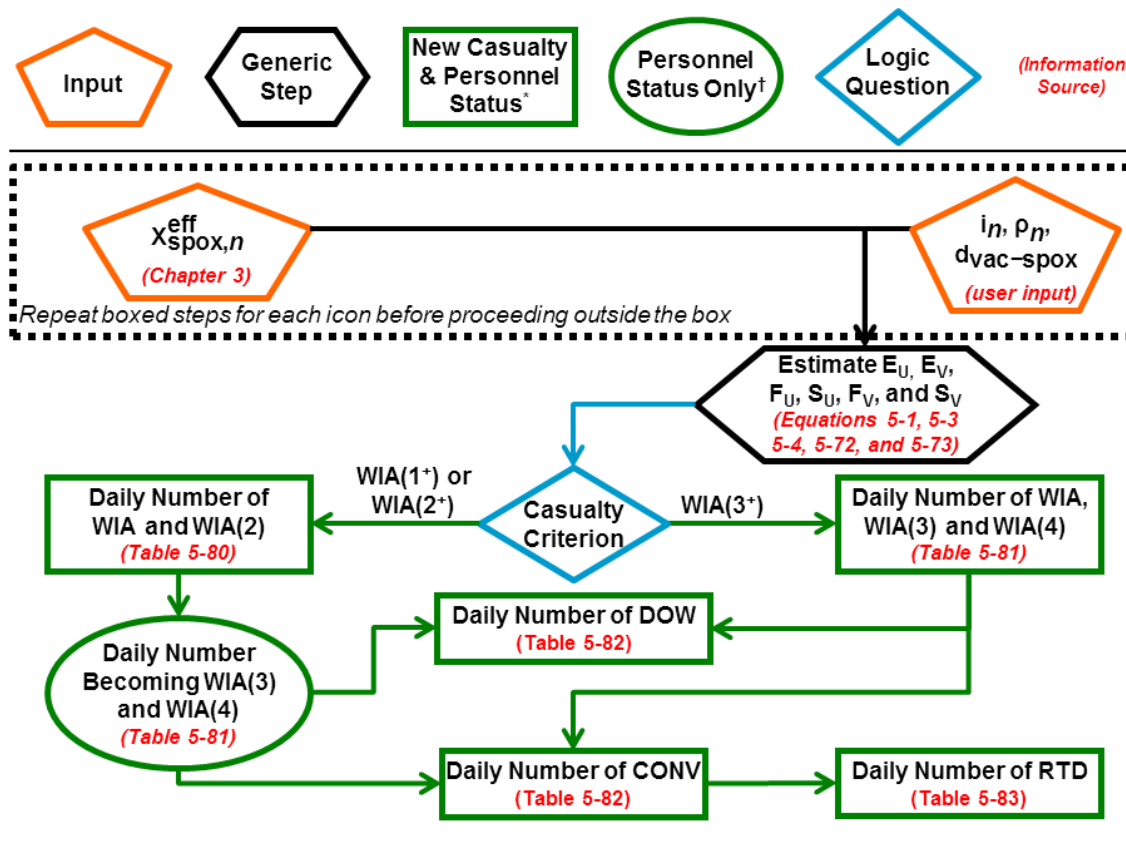

\* Casualty information ( $Pop_{cohort}$ , CAT, table number) is passed to Equations 5-5 through 5-8.  
 † Personnel status information ( $Pop_{cohort}$ , CAT, table number) is passed to Equation 5-7 and 5-8.

**Figure 5-10: Human Response and Casualty Estimation Flowchart for Smallpox (isolation/quarantine model)**

**5.2.10. Smallpox (contagious model)**

1. The contagious smallpox model uses the same Injury Profile (Table 5-77), prophylaxis options (Table 5-78), and infectivity model (Table 5-79) as the isolation/quarantine model. However, the parameter values representing the incubation period and duration of illness models are different because of limitations in the SEIRP model. The SEIRP model also requires values for  $\alpha$  and  $\beta(d)$ . The values of the various parameters for smallpox in the SEIRP model are presented in Table 5-84.

2. Assumptions.

- a. Inhalation of *V. major* results in “ordinary-type” (discrete) smallpox.
- b. The case fatality rates for populations vaccinated before and after exposure (pre-symptom onset) are the same.
- c. Although smallpox survivors go through three stages of illness, the SEIRP

model is a two-stage model. Thus, survivors who are CONV are modeled to move to the  $R_S(d)$  cohort, under the assumption they are not contagious.

**Table 5-84: SEIRP Model Parameter Values for Smallpox**

Parameter	Values
$\rho_E(X_{Q,n}^{eff})$	See Table 5-79
$\rho_S$	0.95
$\rho_E(d)$	See Table 5-78
$\mu_{E1}$	7 days
$\mu_{E2}$	4.6 days
$\mu_1$	3 days
$\mu_2$	14 days
$\mu_{RS}$	5 days
$\alpha$	0
$\beta(d)$	See Table 5-85
$MT_{I1}$	0
$\rho_f(d)$	See Table 5-86

**Table 5-85:  $\beta(d)$  Values for Smallpox<sup>90</sup>**

Day	$\beta(d)$	Day	$\beta(d)$	Day	$\beta(d)$	Day	$\beta(d)$	Day	$\beta(d)$
1	0	13	1.542974	25	0.247143	37	1.446131	49	0.025919
2	0	14	2.111101	26	0.388846	38	0.863064	50	0.018504
3	0	15	2.591886	27	0.604160	39	0.479383	51	0.014492
4	0	16	2.839314	28	0.924223	40	0.240765	52	0.014431
5	0	17	2.732802	29	1.373969	41	0.128126	53	0.014761
6	0	18	2.297896	30	1.811670	42	0.091291	54	0.014046
7	0	19	1.728424	31	2.348062	43	0.081089	55	0.012443
8	0	20	1.049111	32	2.845923	44	0.077639	56	0.009195
9	0.268622	21	0.521604	33	3.144000	45	0.074428	57	0.005397
10	0.455054	22	0.213071	34	3.101436	46	0.068250	58	0.002317
11	0.752619	23	0.108068	35	2.690281	47	0.055961	59	0.000277
12	1.138454	24	0.158733	36	2.115178	48	0.038779	≥60	0

**Table 5-86:  $\rho_f(d)$  Values SEIRP Model for Smallpox**

Days since $d_{vac-spox}$	$\rho_f(d)$	Days since $d_{vac-spox}$	$\rho_f(d)$	Days since $d_{vac-spox}$	$\rho_f(d)$	Days since $d_{vac-spox}$	$\rho_f(d)$	Days since $d_{vac-spox}$	$\rho_f(d)$
1–2	0.30	13	0.24	21	0.18	29–30	0.12	44–48	0.06
3–4	0.29	14–15	0.23	22	0.17	31–32	0.11	49–56	0.05
5–6	0.28	16	0.22	23–24	0.16	33–34	0.10	57–71	0.04
7–8	0.27	17	0.21	25	0.15	35–37	0.09	≥72	0.03
9–10	0.26	18–19	0.20	26–27	0.14	38–40	0.08		
11–12	0.25	20	0.19	28	0.13	41–43	0.07		

<sup>90</sup> Derived from an outbreak in Yugoslavia in 1972.



**5.2.11. Eastern Equine Encephalitis Virus (EEEV) Disease**

1. Figure 5-11 summarizes the human response and casualty estimation processes for EEEV disease, Table 5-87 summarizes the Injury Profile, and Table 5-88 summarizes the other EEEV disease submodels. No prophylaxis is modeled for EEEV disease.
2. Assumptions.
  - a. The disease caused by EEEV is independent of the route of exposure (inhalation versus vector-borne).
  - b. The incidence of encephalitic disease resulting from inhalation of EEEV is negligible in military populations; only the non-lethal systemic febrile syndrome (EEEV disease) occurs.
  - c. The virus is a North American strain.
3. Cohorts and special considerations.
  - a. Medical treatment has no effect on the submodel parameter values.
  - b. EEEV disease does not cause any fatalities, so no F cohort is used and the entire population of the E cohort (calculated by Equation 5-1) moves into S.
4. Table 5-89 through Table 5-90 are the PDTs for EEEV. The values from a given table are to be used in Equations 5-5 through 5-8 with the cohort(s) listed in the table headers and footers, per Figure 5-11.

**Table 5-87: EEEV Disease Injury Profile**

Stage	Injury Severity Level
1	2

**Table 5-88: EEEV Disease Submodel Summary**

Type	Value
<b>Infectivity (<math>\rho_F(X_{EEEVD,n}^{eff})</math>)</b>	
Lognormal Distribution	Use Equation 5-32 ID <sub>50</sub> = 21 PFU Probit slope = 3.8 probits/log(dose))
<b>Lethality (<math>\rho_f(EEEVD)</math>)</b>	
CFR	0%
<b>Incubation Period*</b>	
Lognormal Distribution	Mean = 4.0 days Standard deviation = 1.7 days
<b>Duration of Illness*</b>	
Stage 1: All (S)	
PERT Distribution	Min = 1 day Max = 28 days Median = 5 days

\* Presented for information only. These two submodels have already been convolved to generate the PDTs; the user should use the PDTs to estimate when changes in casualty category occur.

**Table 5-89: Daily Fraction of Individuals Ill with EEEV Disease (E) Who Become WIA, for Casualty Criterion WIA(1+) or WIA(2+)\***

Day	Fraction	Day	Fraction	Day	Fraction	Day	Fraction	Day	Fraction
1	0.0007	5	0.1931	9	0.0143	13	0.0009	≥18	0.0000
2	0.0665	6	0.1109	10	0.0070	14	0.0005		
3	0.2406	7	0.0579	11	0.0035	15	0.0002		
4	0.2730	8	0.0290	12	0.0017	16-17	0.0001		

\* This equates to the time at which all cohorts enter Stage 1 (Severity Level 2).

**Table 5-90: Daily Fraction of EEEV Disease Survivors (S) Who Become RTD**

Day	Fraction	Day	Fraction	Day	Fraction	Day	Fraction	Day	Fraction
≤2	0.0000	9	0.0817	16	0.0518	23	0.0117	30	0.0005
3	0.0005	10	0.0839	17	0.0446	24	0.0086	31	0.0003
4	0.0068	11	0.0825	18	0.0377	25	0.0060	32-33	0.0001
5	0.0233	12	0.0786	19	0.0312	26	0.0041	≥34	0.0000
6	0.0441	13	0.0730	20	0.0253	27	0.0026		
7	0.0623	14	0.0664	21	0.0201	28	0.0016		
8	0.0749	15	0.0592	22	0.0156	29	0.0009		

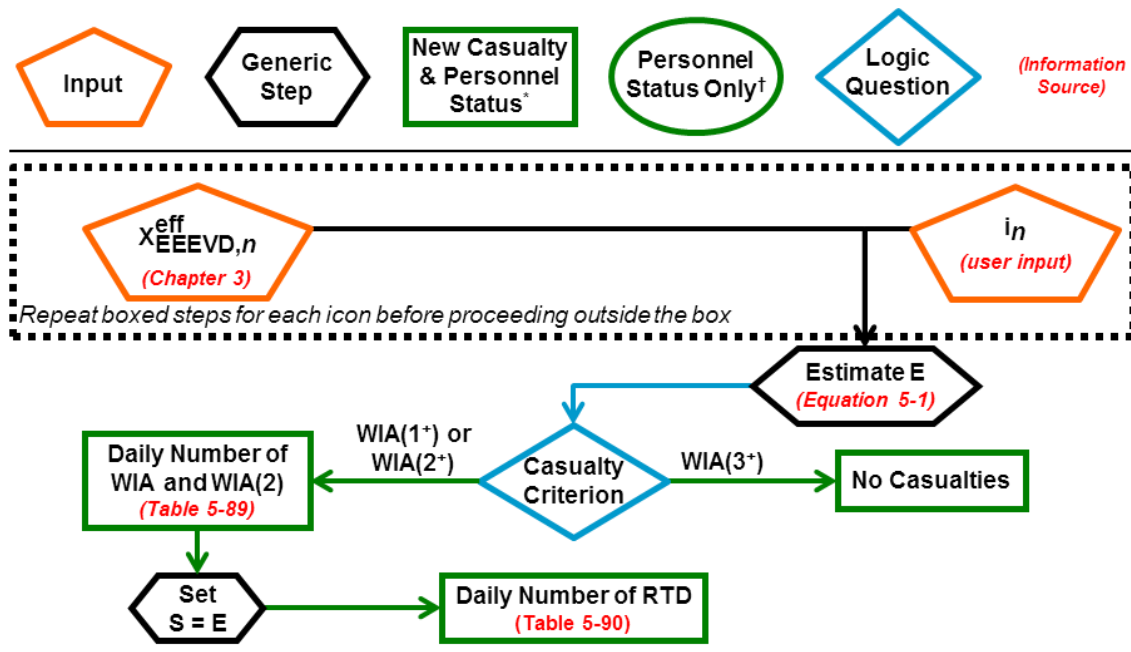

\* Casualty information (Pop<sub>cohort</sub>, CAT, table number) is passed to Equations 5-5 through 5-8.

† Personnel status information (Pop<sub>cohort</sub>, CAT, table number) is passed to Equation 5-7 and 5-8.

**Figure 5-11: Human Response and Casualty Estimation Flowchart for EEEV Disease**

**5.2.12. Venezuelan Equine Encephalitis Virus (VEEV) Disease**

1. Figure 5-12 summarizes the human response and casualty estimation processes for VEEV disease, Table 5-91 summarizes the Injury Profile, and Table 5-

92 summarizes the other VEEV disease submodels. No prophylaxis is modeled for VEEV disease.

2. Assumption. The incidence of encephalitic disease resulting from inhalation of VEEV is negligible in military populations; only the non-lethal systemic febrile syndrome (VEEV disease) occurs.

3. Cohorts and special considerations.

a. Medical treatment has no effect on the submodel parameter values.

b. VEEV disease does not cause any fatalities, so no F cohort is used and the entire population of the E cohort (calculated by Equation 5-1) moves into S.

4. Table 5-93 through Table 5-96 are the PDTs for VEEV disease. The values from a given table are to be used in Equations 5-5 through 5-8 with the cohort(s) listed in the table headers and footers, per Figure 5-12.

**Table 5-91: VEEV Disease Injury Profile**

Stage	Injury Severity Level
1	3
2	2
3	1

**Table 5-92: VEEV Disease Submodel Summary**

Type	Value
<b>Infectivity (<math>\rho_E(X_{VEEVD,n}^{eff})</math>)</b>	
Threshold	Use Equation 5-33 10 PFU
<b>Lethality (<math>\rho_f(VEEVD)</math>)</b>	
CFR	0%
<b>Incubation Period*</b>	
Weibull Distribution	Mean = 1.94 days Standard deviation = 1.24 days
<b>Duration of Illness*</b>	
Stage 1: All (S)	
Discrete	80%: 2 days 20%: 3 days
Stage 2: All (S)	
Lognormal Distribution	Mean = 3.47 days Standard deviation = 2.80 days
Stage 3: All (S)	
Lognormal Distribution	Mean = 4.84 days Standard deviation = 3.81 days

\* Presented for information only. These two submodels have already been convolved to generate the PDTs; the user should use the PDTs to estimate when changes in casualty category occur.

**Table 5-93: Daily Fraction of Individuals Ill with VEEV Disease (E) Who Become WIA, for Any Casualty Criterion\***

Day	Fraction	Day	Fraction	Day	Fraction	Day	Fraction	Day	Fraction
1	0.2530	3	0.2288	5	0.0468	7	0.0045	9	0.0003
2	0.3340	4	0.1157	6	0.0158	8	0.0011	≥10	0.0000

\* This equates to the time at which all cohorts enter Stage 1 (Severity Level 3).

**Table 5-94: Daily Fraction of VEEV Disease Survivors (S) Who Enter Stage 2 of Illness**

Day	Fraction	Day	Fraction	Day	Fraction	Day	Fraction
≤2	0.0000	5	0.2498	8	0.0220	11	0.0004
3	0.2024	6	0.1383	9	0.0068	12	0.0001
4	0.3178	7	0.060	10	0.0018	≥13	0.0000

**Table 5-95: Daily Fraction of VEEV Disease Survivors (S) Who Enter Stage 3 of Illness**

Day	Fraction	Day	Fraction	Day	Fraction	Day	Fraction	Day	Fraction
≤2	0.0000	8	0.1484	14	0.0153	20	0.0020	26	0.0004
3	0.0024	9	0.1107	15	0.0105	21	0.0015	27	0.0003
4	0.0399	10	0.0768	16	0.0073	22	0.0011	28–30	0.0002
5	0.1151	11	0.0514	17	0.0052	23	0.0009	31–35	0.0001
6	0.1695	12	0.0341	18	0.0037	24	0.0007	≥36	0.0000
7	0.1758	13	0.0227	19	0.0027	25	0.0005		

**Table 5-96: Daily Fraction of VEEV Disease Survivors (S) Who Become RTD**

Day	Fraction	Day	Fraction	Day	Fraction	Day	Fraction	Day	Fraction
≤3	0.0000	11	0.1086	19	0.0233	27	0.0035	35	0.0007
4	0.0002	12	0.1000	20	0.0183	28	0.0028	36	0.0006
5	0.0037	13	0.0871	21	0.0143	29	0.0023	37	0.0005
6	0.0175	14	0.0729	22	0.0113	30	0.0018	38	0.0004
7	0.0435	15	0.0595	23	0.0089	31	0.0015	39–40	0.0003
8	0.0735	16	0.0477	24	0.0070	32	0.0012	41–43	0.0002
9	0.0972	17	0.0378	25	0.0056	33	0.0010	44–52	0.0001
10	0.1089	18	0.0298	26	0.0044	34	0.0008	≥53	0.0000

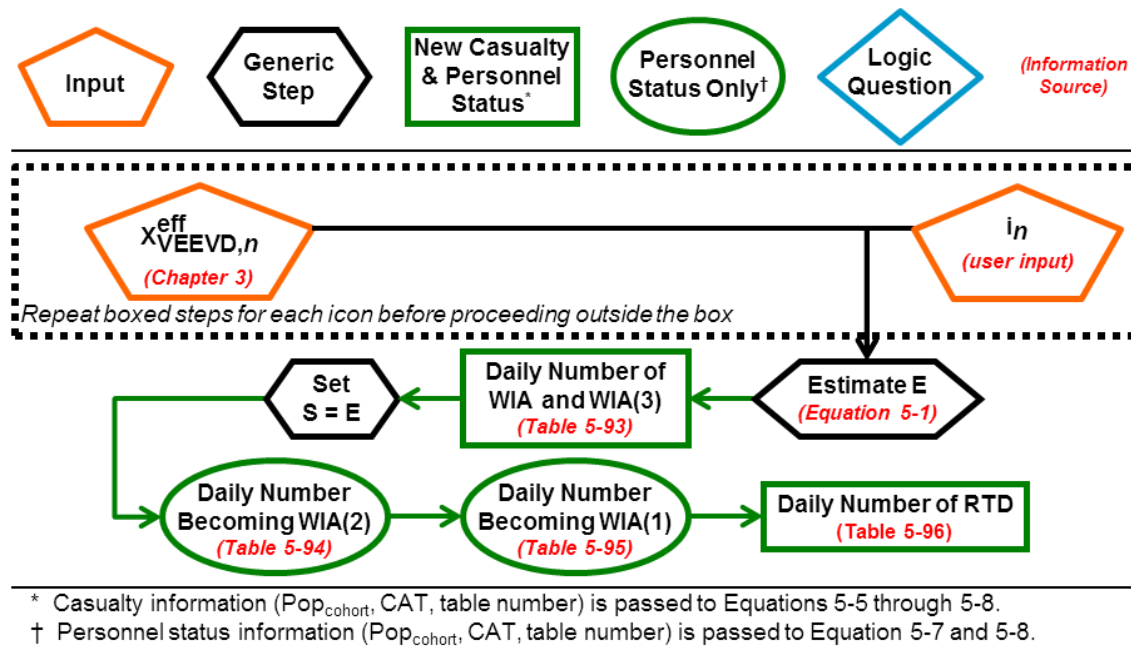

**Figure 5-12: Human Response and Casualty Estimation  
Flowchart for VEEV Disease**

### 5.2.13. Western Equine Encephalitis Virus (WEEV) Disease

1. Figure 5-13 summarizes the human response and casualty estimation processes for WEEV disease, Table 5-97 summarizes the Injury Profile, and Table 5-98 summarizes the other WEEV disease submodels. No prophylaxis is modeled for WEEV disease.
2. Assumptions.
  - a. The disease caused by WEEV is independent of the route of exposure (inhalation versus vector-borne).
  - b. The incidence of encephalitic disease resulting from inhalation of WEEV is negligible in military populations; only the non-lethal systemic febrile syndrome (WEEV disease) occurs.
  - c. All strains can be represented by a single set of model parameter values.
3. Cohorts and special considerations.
  - a. Medical treatment has no effect on the submodel parameter values.
  - b. WEEV disease does not cause any fatalities, so no F cohort is used and the entire population of the E cohort (calculated by Equation 5-1) moves into S.
4. Table 5-99 through Table 5-100 are the PDTs for WEEV disease. The values

from a given table are to be used in Equations 5-5 through 5-8 with the cohort(s) listed in the table headers and footers, per Figure 5-13.

**Table 5-97: WEEV Disease Injury Profile**

Stage	Injury Severity Level
1	2

**Table 5-98: WEEV Disease Submodel Summary**

Type	Value
<b>Infectivity (<math>p_E(X_{WEEVD,n}^{eff})</math>)</b>	
Lognormal Distribution	Use Equation 5-32 ID <sub>50</sub> = 15 PFU; Probit slope = 3.1 probits/log(dose))
<b>Lethality (<math>p_f(WEEVD)</math>)</b>	
CFR	0%
<b>Incubation Period *</b>	
Lognormal Distribution	Mean = 4.7 days Standard deviation = 0.9 days
<b>Duration of Illness *</b>	
Stage 1: All (S)	
Lognormal Distribution	Mean = 4.4 days Standard deviation = 1.9 days

\* Presented for information only. These two submodels have already been convolved to generate the PDTs; the user should use the PDTs to estimate when changes in casualty category occur.

**Table 5-99: Daily Fraction of Individuals Ill with WEEV Disease (E) Who Become WIA, for Casualty Criterion WIA(1+) or WIA(2+)\***

Day	Fraction	Day	Fraction	Day	Fraction	Day	Fraction
1	0.0000	4	0.2136	7	0.0694	10	0.0002
2	0.0000	5	0.4380	8	0.0122	≥11	0.0000
3	0.0116	6	0.2534	9	0.0017		

\* This equates to the time at which all cohorts enter Stage 1 (Severity Level 2).

**Table 5-100: Daily Fraction of WEEV Disease Survivors (S) Who Become RTD**

Day	Fraction	Day	Fraction	Day	Fraction	Day	Fraction	Day	Fraction
≤4	0.0000	9	0.2138	14	0.0225	19	0.0010	25	0.0000
5	0.0023	10	0.1764	15	0.0121	20	0.0006		
6	0.0280	11	0.1201	16	0.0064	21	0.0003		
7	0.1058	12	0.0728	17	0.0035	22	0.0002		
8	0.1909	13	0.0412	18	0.0019	23-24	0.0001		

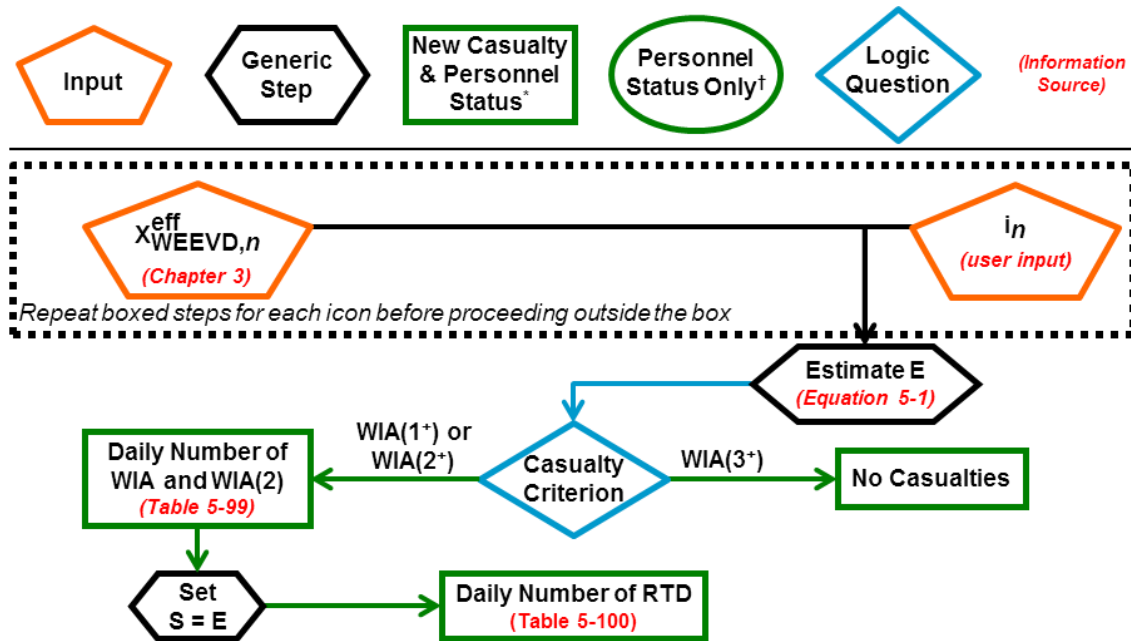

\* Casualty information (Pop<sub>cohort</sub>, CAT, table number) is passed to Equations 5-5 through 5-8.  
 † Personnel status information (Pop<sub>cohort</sub>, CAT, table number) is passed to Equation 5-7 and 5-8.

**Figure 5-13: Human Response and Casualty Estimation Flowchart for WEEV Disease**

**5.2.14. Botulism**

1. Figure 5-14 summarizes the human response and casualty estimation processes for botulism, Table 5-104 summarizes the Injury Profile, Table 5-106 summarizes the other botulism submodels, and Table 5-49 summarizes the available botulism prophylaxis options.

2. Assumptions, limitation, and constraints.

a. Assumptions.

- 1) All individuals weigh 70 kilograms.
- 2) The inhalation and ingestion forms of botulism are similar in course, signs and symptoms, and severity, such that data from ingestion botulism may be used to inform models of inhalation botulism.

- b. Limitation. Although the model requires the user to specify a day on which the antitoxin becomes available ( $d_{\text{trt-bot}}$ ), it does *not* apply the antitoxin to every person on that day; only those who have been declared WIA are modeled to receive antitoxin on that day. Those who are declared WIA after  $d_{\text{trt-bot}}$  are modeled to receive the antitoxin on the day they are declared WIA.
- c. Constraints.
- 1) The models are based on Serotype A.
  - 2) Upon receiving antitoxin, individuals are modeled to complete the stage they are already in without modification of that stage's duration of illness due to receiving the antitoxin. The duration(s) of subsequent stage(s) of illness are modified because of the antitoxin.
3. Cohorts and special considerations.
- a. If  $\text{Flag}_{\text{MT}} = \text{No}$ , the number of people estimated to die according to the untreated lethality model are moved from E into  $F_{\text{U}}$ , and the remainder move into  $S_{\text{U}}$  (according to Equations 5-2 and 5-4).
  - b. If  $\text{Flag}_{\text{MT}} = \text{Yes}$ , the E cohort is split among several sub-cohorts, based on the user-chosen day on which antitoxin becomes available ( $d_{\text{trt-bot}}$ ).
    - 1) E is first split between those who inhaled a dose that is lethal in absence of antitoxin ( $E_{\text{leth}}$ ) and those who inhaled an effective, but nonlethal, dose ( $S_{\text{eff}}$ ), based on the untreated, dose-dependent lethality model (Table 5-106) and Equations 5-2 and 5-4. The sublethal dose treated sub-cohort ( $S_{\text{eff}}$ ) remains separate from the sub-cohorts described below.
    - 2) Individuals in the  $E_{\text{leth}}$  sub-cohort are assumed to require respiratory support ("ventilation") if they do not receive antitoxin prior to reaching Stage 3 of botulism. The exact method by which  $E_{\text{leth}}$  is divided among several sub-cohorts is dependent upon the casualty criterion.
    - 3) Regardless of the casualty criterion, the following logic and Equations 5-74 to 5-76 are applied to calculate the populations of three sub-cohorts.
      - a) Individuals who have already died by  $d_{\text{trt-bot}}$  (untreated non-survivors) are placed in the  $F_{\text{U}}$  sub-cohort.
      - b) Individuals in Stage 3 on  $d_{\text{trt-bot}}$  are split between the  $S_{\text{vent}}$  (treated ventilated survivor) and  $F_{\text{vent}}$  (treated ventilated non-survivor) sub-cohorts, based on the treated lethality model (Table 5-106).

$$F_{\text{U}} = E_{\text{leth}} \cdot P_{\text{DOW}} \quad (5-74)$$

$$F_{\text{vent}} = E_{\text{leth}} \cdot 0.12 \cdot P_{\text{in-Stg3}} \quad (5-75)$$



$$S_{vent} = E_{leth} \cdot 0.88 \cdot P_{in-Stg3} \tag{5-76}$$

- 4) If the casualty criterion is WIA(1+) or WIA(2+), individuals who have not yet reached Stage 3 on  $d_{trt-bot}$  are placed in one of two treated unventilated survivor sub-cohorts, based on whether they are Stage 1 or the latent period ( $S_{unvent-1}$ ), or Stage 2 ( $S_{unvent-2}$ ). Equations 5-77 and 5-78 are applied to calculate the populations of these final two sub-cohorts.

$$S_{unvent-2} = E_{leth} \cdot P_{in-Stg2} \tag{5-77}$$

$$S_{unvent-1} = E_{leth} - F_U - F_{vent} - S_{vent} - S_{unvent-2} \tag{5-78}$$

- 5) If the casualty criterion is WIA(3+), anyone not already dead or in Stage 3 on  $d_{trt-bot}$  is lumped together in  $S_{unvent-2}$  (using Equation 5-79) because regardless of whether an individual is in the latent period, Stage 1, or Stage 2 on  $d_{trt-bot}$ , they will not receive antitoxin until they are declared WIA upon entering Stage 2.

$$S_{unvent-2} = E_{leth} - F_U - F_{vent} - S_{vent} \tag{5-79}$$

In Equations 5-74 to 5-79:

$P_{DOW}$  is the probability that an individual in the  $E_{leth}$  cohort is DOW on  $d_{trt-bot}$  (see Table 5-101), and

$P_{in-Stg3}$  is the probability that an individual in the  $E_{leth}$  cohort is in Stage 3 on  $d_{trt-bot}$  (see Table 5-102), and

$P_{in-Stg2}$  is the probability that an individual in the  $E_{leth}$  cohort is in Stage 2 on  $d_{trt-bot}$  (see Table 5-103).

**Table 5-101: Probability That an Individual in the  $E_{leth}$  Cohort is DOW On  $d_{trt-bot}$  ( $P_{DOW}$ )**

$d_{trt-bot}$	$P_{DOW}$	$d_{trt-bot}$	$P_{DOW}$	$d_{trt-bot}$	$P_{DOW}$	$d_{trt-bot}$	$P_{DOW}$	$d_{trt-bot}$	$P_{DOW}$
0	0.0000	5	0.6466	10	0.9731	15	0.9976	20	0.9996
1	0.0064	6	0.7785	11	0.9841	16	0.9984	21	0.9997
2	0.0862	7	0.8664	12	0.9904	17	0.9989	22	0.9998
3	0.2620	8	0.9212	13	0.9941	18	0.9992	23	0.9999
4	0.4677	9	0.9540	14	0.9963	19	0.9994	≥24	1.0000

**Table 5-102: Probability That an Individual in the E<sub>leth</sub> Cohort is in Stage 3 of Botulism On d<sub>trt-bot</sub> (P<sub>in-Stg3</sub>)**

d <sub>trt-bot</sub>	P <sub>in-Stg3</sub>	d <sub>trt-bot</sub>	P <sub>in-Stg3</sub>	d <sub>trt-bot</sub>	P <sub>in-Stg3</sub>	d <sub>trt-bot</sub>	P <sub>in-Stg3</sub>	d <sub>trt-bot</sub>	P <sub>in-Stg3</sub>
0	0.0000	5	0.1643	10	0.0151	15	0.0011	20	0.0002
1	0.0297	6	0.1139	11	0.0087	16	0.0007	21	0.0002
2	0.1432	7	0.0729	12	0.0051	17	0.0005	22	0.0002
3	0.2141	8	0.0443	13	0.0030	18	0.0004	23	0.0001
4	0.2089	9	0.0261	14	0.0018	19	0.0003	≥24	0.0000

**Table 5-103: Probability That an Individual in the E<sub>leth</sub> Cohort is in Stage 2 of Botulism On d<sub>trt-bot</sub> (P<sub>in-Stg2</sub>)**

d <sub>trt-bot</sub>	P <sub>in-Stg2</sub>	d <sub>trt-bot</sub>	P <sub>in-Stg2</sub>	d <sub>trt-bot</sub>	P <sub>in-Stg2</sub>	d <sub>trt-bot</sub>	P <sub>in-Stg2</sub>	d <sub>trt-bot</sub>	P <sub>in-Stg2</sub>
0	0.0000	5	0.1100	10	0.0063	15	0.0005	20	0.0001
1	0.1219	6	0.0644	11	0.0036	16	0.0003	21	0.0001
2	0.2580	7	0.0363	12	0.0021	17	0.0002	≥22	0.0000
3	0.2441	8	0.0202	13	0.0013	18	0.0001		
4	0.1750	9	0.0112	14	0.0008	19	0.0001		

4. Table 5-107 through Table 5-119 are the PDTs for botulism. The values from a given table are to be used in Equations 5-5 through 5-8 with the cohort(s) listed in the table headers and footers, per Figure 5-14.

**Table 5-104: Botulism Injury Profile**

Stage	Injury Severity Level
Untreated Non-Survivors (F <sub>U</sub> ) Treated, Ventilated Non-Survivors (F <sub>vent</sub> )	
1	2
2	3
3	4
Untreated Survivors (S <sub>U</sub> )	
1	2
2	3
3	2
Treated, Sub-lethal Dose Survivors (S <sub>eff</sub> ), Treated, Unventilated Survivors (S <sub>unvent-1</sub> and S <sub>unvent-2</sub> )	
1	2
2	3
CONV	CONV
Treated, Ventilated Survivors (S <sub>vent</sub> )	
1	2
2	3
3	4
CONV	CONV

**Table 5-105: Botulism Prophylaxis Summary**

Type of Prophylaxis	Efficacy (ρ <sub>n</sub> )
Pre-exposure vaccination	1.00

**Table 5-106: Botulism Submodel Summary**

Type	Value
<b>Effectivity (<math>\rho_E(X_{bot,n}^{eff})</math>)</b>	
Lognormal Distribution	Use Equation 5-32 ED <sub>50</sub> = 0.1 µg Probit slope = 12.5 probits/log(dose)
<b>Lethality</b>	
Untreated ( $\rho_f(X_{bot,n}^{eff})$ )	
Lognormal Distribution	Use Equation 5-32 LD <sub>50</sub> = 0.8 µg Probit slope = 12.5 probits/log(dose)
Treated with Antitoxin Prior to Stage 3 ( $\rho_f(bot)$ )	
CFR	0%
Treated with Antitoxin After Onset of Stage 3 ( $\rho_f(bot)$ )	
CFR	12%
<b>Latent Period</b> *	
Lognormal Distribution	Mean = 1.42 days Standard deviation = 1.44 days
<b>Duration of Illness</b> *	
Stage 1: Survivors, Untreated ( $S_U$ )	
Stage 1: Survivors, Treated, Sublethal Dose ( $S_{eff}$ )	
Constant	1 day
Stage 2: Survivors, Untreated ( $S_U$ )	
Constant	14 days
Stage 3: Survivors, Untreated ( $S_U$ )	
CONV: Survivors, Treated, Sublethal Dose ( $S_{eff}$ )	
Constant	180 days
Stage 2: Survivors, Treated, Sublethal Dose ( $S_{eff}$ )	
Stage 2: Survivors, Stage 1 Treated Unventilated ( $S_{unvent-1}$ )	
Constant	7 days
CONV: Survivors, Stage 1 Treated Unventilated ( $S_{unvent-1}$ )	
CONV: Survivors, Stage 2 Treated Unventilated ( $S_{unvent-2}$ )	
Constant	270 days
Stages 1, 2, and 3 (each): Non-Survivors, Untreated ( $F_U$ )	
Stages 1 and 2 (each): Non-Survivors, Treated Ventilated ( $F_{vent}$ )	
Stages 1 and 2 (each): Survivors, Treated Ventilated ( $S_{vent}$ )	
Stage 1: Survivors, Stage 1 Treated Unventilated ( $S_{unvent-1}$ )	
Stages 1 and 2 (each): Survivors, Stage 2 Treated Unventilated ( $S_{unvent-2}$ )	
Exponential Distribution	Mean = 1.04 days
Stage 3: Non-Survivors, Treated Ventilated ( $F_{vent}$ )	
Stage 3: Survivors, Treated Ventilated ( $S_{vent}$ )	
Constant	70 days
CONV: Survivors, Treated Ventilated ( $S_{vent}$ )	
Constant	Indefinite

\* Presented for information only. These two submodels have already been convolved to generate the PDTs; the user should use the PDTs to estimate when changes in casualty category occur.

**Table 5-107: Daily Fraction of Individuals Ill with Botulism (E) Who Become WIA, for Casualty Criterion WIA(1+) or WIA(2+)**

Day	Fraction	Day	Fraction	Day	Fraction	Day	Fraction	Day	Fraction
1	0.5000	6	0.0112	11	0.0009	16	0.0002	≥21	0.0000
2	0.2954	7	0.0062	12	0.0006	17	0.0001		
3	0.1092	8	0.0036	13	0.0004	18	0.0001		
4	0.0460	9	0.0022	14	0.0003	19	0.0001		
5	0.0218	10	0.0014	15	0.0002	20	0.0001		

\* This equates to the time at which all cohorts enter Stage 1 (Severity Level 2).

**Table 5-108: Daily Fraction of Untreated Non-Survivors ( $F_U$ ), Treated Ventilated Non-Survivors ( $F_{vent}$ ), Treated Ventilated Survivors ( $S_{vent}$ ), and Stage 2 Treated Unventilated Survivors ( $S_{unvent-2}$ ) Ill with Botulism Who Become WIA, for Casualty Criterion WIA(3+)**

Day	Fraction	Day	Fraction	Day	Fraction	Day	Fraction	Day	Fraction
1	0.1580	5	0.0693	9	0.0056	13	0.0008	18–21	0.0001
2	0.3294	6	0.0359	10	0.0032	14	0.0005	≥22	0.0000
3	0.2328	7	0.0188	11	0.0019	15	0.0003		
4	0.1314	8	0.0101	12	0.0012	16–17	0.0002		

\* This equates to the time at which the listed cohorts and the  $S_{unvent-1}$  cohort enter Stage 2 (Severity Level 3).

**Table 5-109: Daily Fraction of Untreated Survivors ( $S_U$ ) and Treated Sub-lethal Dose Survivors ( $S_{eff}$ ) Ill with Botulism Who Become WIA, for Casualty Criterion WIA(3+)**

Day	Fraction	Day	Fraction	Day	Fraction	Day	Fraction	Day	Fraction
1	0.0000	5	0.0460	9	0.0036	13	0.0006	18–21	0.0001
2	0.5000	6	0.0218	10	0.0022	14	0.0004	≥22	0.0000
3	0.2954	7	0.0112	11	0.0014	15	0.0003		
4	0.1092	8	0.0062	12	0.0009	16–17	0.0002		

\* This equates to the time at which the listed cohorts enter Stage 2 (Severity Level 3).

**Table 5-110: Daily Fraction of Untreated Botulism Non-Survivors ( $F_U$ ) Who DOW**

Day	Fraction	Day	Fraction	Day	Fraction	Day	Fraction	Day	Fraction
1	0.0064	6	0.1319	11	0.0110	16	0.0008	≥25	0.0000
2	0.0798	7	0.0879	12	0.0063	17	0.0005		
3	0.1758	8	0.0548	13	0.0037	18	0.0003		
4	0.2057	9	0.0328	14	0.0022	19–20	0.0002		
5	0.1789	10	0.0191	15	0.0013	20–24	0.0001		

**Table 5-111: Daily Fraction of Untreated Botulism Survivors ( $S_U$ ) Who Enter Stage 3 of Illness**

Day	Fraction	Day	Fraction	Day	Fraction	Day	Fraction	Day	Fraction
≥15	0.0000	19	0.0460	23	0.0036	27	0.0006	32–35	0.0001
16	0.5000	20	0.0218	24	0.0022	28	0.0004	≥36	0.0000
17	0.2954	21	0.0112	25	0.0014	29	0.0003		
18	0.1092	22	0.0062	26	0.0009	30–31	0.0002		

**Table 5-112: Daily Fraction of Untreated Botulism Survivors ( $S_u$ ) Who Become RTD**

Day	Fraction	Day	Fraction	Day	Fraction	Day	Fraction	Day	Fraction
≥195	0.0000	199	0.0460	203	0.0036	207	0.0006	212–215	0.0001
196	0.5000	200	0.0218	204	0.0022	208	0.0004	≥216	0.0000
197	0.2954	201	0.0112	205	0.0014	209	0.0003		
198	0.1092	202	0.0062	206	0.0009	210–211	0.0002		

**Table 5-113: Daily Fraction of Treated Ventilated Botulism Non-Survivors ( $F_{vent}$ ) Who DOW; Daily Fraction of Treated Ventilated Botulism Survivors ( $S_{vent}$ ) Who Become CONV**

Day	Fraction	Day	Fraction	Day	Fraction	Day	Fraction	Day	Fraction
≤70	0.0000	75	0.1343	80	0.0081	85	0.0006	≥93	0.0000
71	0.0361	76	0.0815	81	0.0046	86	0.0004		
72	0.1933	77	0.0469	82	0.0027	87	0.0003		
73	0.2467	78	0.0262	83	0.0016	88	0.0002		
74	0.2005	79	0.0146	84	0.0010	89–92	0.0001		

\* This equates to the time at which the  $S_{vent}$  cohort enters Stage 4 (Severity Level 2).

**Table 5-114: Daily Fraction of Treated Sub-lethal Dose Botulism Survivors ( $S_{eff}$ ) Who Become CONV**

Day	Fraction	Day	Fraction	Day	Fraction	Day	Fraction	Day	Fraction
≤8	0.0000	12	0.0460	16	0.0036	20	0.0006	25–28	0.0001
9	0.5000	13	0.0218	17	0.0022	21	0.0004	≥29	0.0000
10	0.2954	14	0.0112	18	0.0014	22	0.0003		
11	0.1092	15	0.0062	19	0.0009	23–24	0.0002		

\* This equates to the time at which the listed cohort enters Stage 3 (Severity Level 2).

**Table 5-115: Daily Fraction of Treated Sub-lethal Dose Botulism Survivors ( $S_{eff}$ ) Who Become RTD**

Day	Fraction	Day	Fraction	Day	Fraction	Day	Fraction	Day	Fraction
≤188	0.0000	192	0.0460	196	0.0036	200	0.0006	205–208	0.0001
189	0.5000	193	0.0218	197	0.0022	201	0.0004	≥209	0.0000
190	0.2954	194	0.0112	198	0.0014	202	0.0003		
191	0.1092	195	0.0062	199	0.0009	203–204	0.0002		

**Table 5-116: Daily Fraction of Stage 1 Treated Unventilated Botulism Survivors ( $S_{unvent-1}$ ) Who Become CONV**

Day	Fraction	Day	Fraction	Day	Fraction	Day	Fraction	Day	Fraction
≤7	0.0000	11	0.1314	15	0.0101	19	0.0012	23–24	0.0002
8	0.1580	12	0.0693	16	0.0056	20	0.0008	25–28	0.0001
9	0.3294	13	0.0359	17	0.0032	21	0.0005	≥29	0.0000
10	0.2328	14	0.0188	18	0.0019	22	0.0003		

\* This equates to the time at which the listed cohort enters Stage 3 (Severity Level 2).

**Table 5-117: Daily Fraction of Stage 1 Treated Unventilated Botulism Survivors ( $S_{\text{unvent-1}}$ ) Who Become RTD**

Day	Fraction	Day	Fraction	Day	Fraction	Day	Fraction	Day	Fraction
$\leq 277$	0.0000	281	0.1314	285	0.0101	289	0.0012	293–294	0.0002
278	0.1580	282	0.0693	286	0.0056	290	0.0008	295–298	0.0001
279	0.3294	283	0.0359	287	0.0032	291	0.0005	$\geq 299$	0.0000
280	0.2328	284	0.0188	288	0.0019	292	0.0003		

**Table 5-118: Daily Fraction of Stage 2 Treated Unventilated Botulism Survivors ( $S_{\text{unvent-2}}$ ) Who Become CONV**

Day	Fraction	Day	Fraction	Day	Fraction	Day	Fraction	Day	Fraction
1	0.0361	5	0.1343	9	0.0146	13	0.0016	17	0.0003
2	0.1933	6	0.0815	10	0.0081	14	0.0010	18	0.0002
3	0.2467	7	0.0469	11	0.0046	15	0.0006	19–22	0.0001
4	0.2005	8	0.0262	12	0.0027	16	0.0004	$\geq 23$	0.0000

\* This equates to the time at which the listed cohort and the  $F_U$ ,  $S_{\text{vent}}$ , and  $F_{\text{vent}}$  cohorts enter Stage 3 (Severity Level 4 for  $F_U$ ,  $S_{\text{vent}}$ , and  $F_{\text{vent}}$ , and Severity Level 2 for  $S_{\text{unvent-2}}$ ).

**Table 5-119: Daily Fraction of Stage 2 Treated Unventilated Botulism Survivors ( $S_{\text{unvent-2}}$ ) Who Become RTD**

Day	Fraction	Day	Fraction	Day	Fraction	Day	Fraction	Day	Fraction
$\leq 270$	0.0000	275	0.1343	280	0.0081	285	0.0006	$\geq 293$	0.0000
271	0.0361	276	0.0815	281	0.0046	286	0.0004		
272	0.1933	277	0.0469	282	0.0027	287	0.0003		
273	0.2467	278	0.0262	283	0.0016	288	0.0002		
274	0.2005	279	0.0146	284	0.0010	289–292	0.0001		

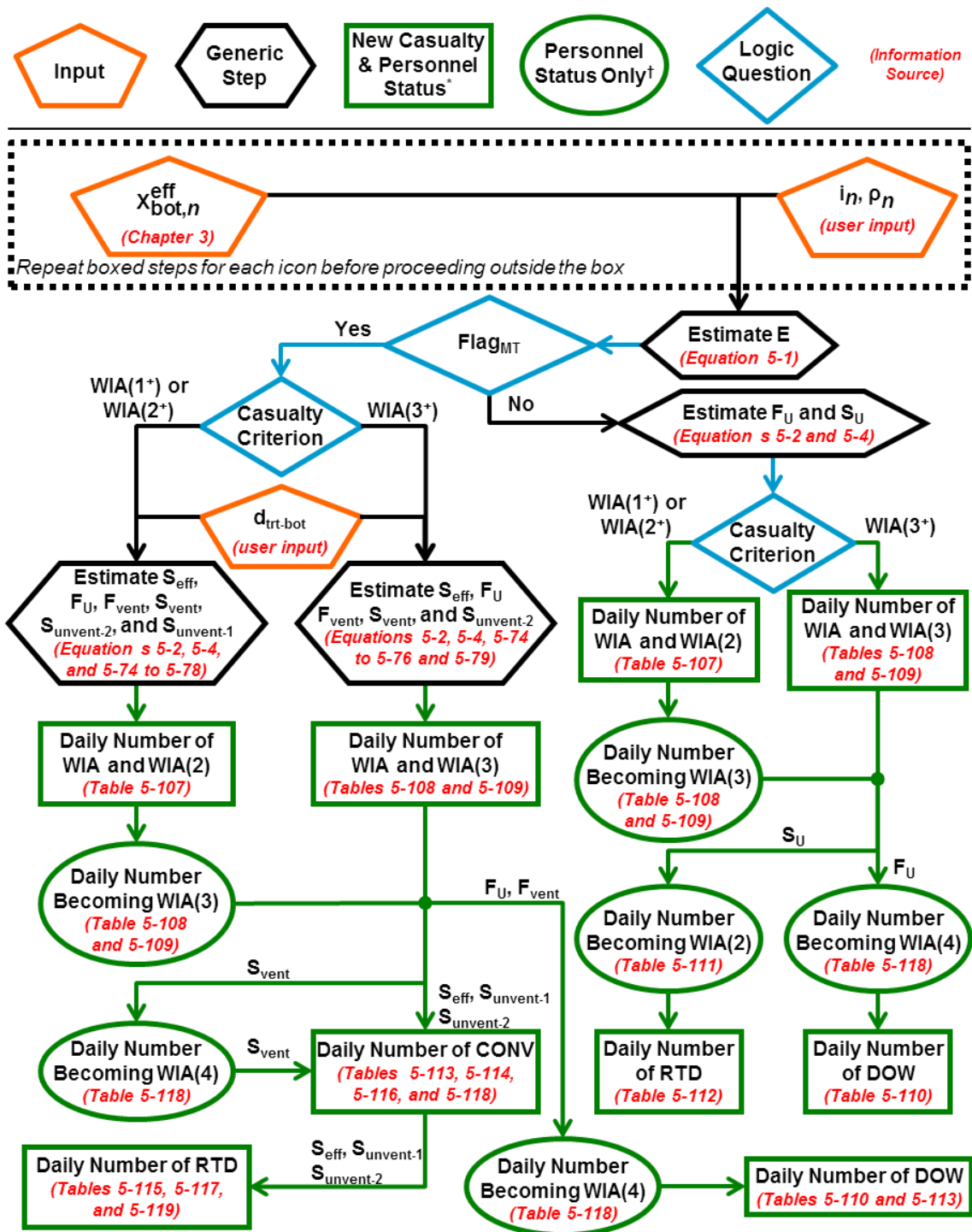

\* Casualty information (Pop<sub>cohort</sub>, CAT, table number) is passed to Equations 5-5 through 5-8.  
 † Personnel status information (Pop<sub>cohort</sub>, CAT, table number) is passed to Equation 5-7 and 5-8.

Figure 5-14: Human Response and Casualty Estimation Flowchart for Botulism

### 5.2.15. Ricin Intoxication

1. Figure 5-15 summarizes the human response and casualty estimation processes for ricin intoxication, Table 5-121 summarizes the Injury Profile, and Table 5-122 summarizes the other ricin intoxication submodels. No prophylaxis is modeled for ricin intoxication.
2. Assumptions.
  - a. All individuals weigh 70 kilograms.
  - b. The effectivity probit slope is equal to the lethality probit slope.
3. Cohorts and special considerations.
  - a. Medical treatment has no effect on the submodel parameter values.
  - b. Because the duration of illness is dose-dependent, and that dose-dependence differs by stage of illness and by survivor versus non-survivor, the following steps must be taken.
    - 1) The populations of E, F, and S are calculated using Equations 5-1, 5-2, and 5-4.
    - 2) As Stage 1 and Stage 2 for survivors are both Severity Level 1, a separate table for the time at which survivors enter Stage 2 is not needed. Further, the time until Stage 1 and until RTD are fixed, so the dose-dependence of the length of Stage 1 has no practical bearing on the model. Thus, S is not split into sub-cohorts; it remains as S.
    - 3) A different dose range is required for each stage of illness for non-survivors. As such, Table 5-120 lists the dose ranges for each stage of illness; the specific labels for the F<sub>DR</sub> cohorts differ by stage of illness.

**Table 5-120: Ricin Intoxication Dose Ranges for the F<sub>DR</sub> Sub-Cohorts**

Duration of Stage 1		Duration of Stage 2		Duration of Stage 3	
Dose Range Label (DR)	Dose Range [µg]	Dose Range Label (DR)	Dose Range [µg]	Dose Range Label (DR)	Dose Range [µg]
Stg2-A	0-<11	Stg3-A	0-<11	DOW-A	0-<13
Stg2-B	11-<41	Stg3-B	11-<24	DOW-B	13-<19
Stg2-C	41-<415	Stg3-C	24-<63	DOW-C	19-<30
Stg2-D	≥415	Stg3-D	63-<244	DOW-D	30-<50
		Stg3-E	244-<2,455	DOW-E	50-<92
		Stg3-F	≥2,455	DOW-F	92-<193
				DOW-G	193-<504
				DOW-H	504-<1,946
				DOW-I	1,946-<19,619
				DOW-J	≥19,619

4. Table 5-123 through Table 5-127 are the PDTs for ricin intoxication. The values



from a given table are to be used in Equations 5-5 through 5-8 with the cohort(s) listed in the table headers and footers, per Figure 5-15.

**Table 5-121: Ricin Intoxication Injury Profile**

Stage	Injury Severity Level
Non-Survivors ( $F_{DR}$ )	
1	1
2	3
3	4
Survivors (S)	
1	1
2	1

**Table 5-122: Ricin Intoxication Submodel Summary**

Type	Value
<b>Effectivity (<math>p_E(X_{ricin,n}^{eff})</math>)</b>	
Lognormal Distribution	Use Equation 5-32 ED <sub>50</sub> = 120 µg Probit slope = 6.1 probits/log(dose)
<b>Lethality (<math>p_L(X_{ricin,n}^{eff})</math>)</b>	
Lognormal Distribution	Use Equation 5-32 LD <sub>50</sub> = 343 µg Probit slope = 6.1 probits/log(dose)
<b>Latent Period*</b>	
Constant	6 hours
<b>Duration of Illness*</b>	
Stage 1: Non-Survivors ( $F_{DR}$ )	
Power Function	Dose-dependent: <1–4 days c = 6.1 r = -0.3
Stage 2: Non-Survivors ( $F_{DR}$ )	
Power Function	Dose-dependent: <1–6 days c = 4.3 r = -0.3
Stage 3: Non-Survivors ( $F_{DR}$ )	
Power Function	Dose-dependent: <1–10 days c = 9.0 r = -0.3
Stage 1: Survivors (S)	
Power Function	Dose-dependent: <1–6 days c = 10.4 r = -0.3
Total Duration: Survivors (S)	
Constant	192 hours

\* Presented for information only. These two submodels have already been convolved to generate the PDTs; the user should use the PDTs to estimate when changes in casualty category occur.

**Table 5-123: Daily Fraction of Individuals Ill with Ricin Intoxication (E) Who Become WIA, for WIA(1+)**

Day	Fraction
1	1.0000
≥2	0.0000

\* This equates to the time at which all cohorts enter Stage 1 (Severity Level 1). As Stage 2 for survivors is also Severity Level 1, a separate table indicating the time until Stage 2 is not needed.

**Table 5-124: Dose-Dependent Day on Which Ricin Intoxication Non-Survivors ( $F_{Stg2-x}$ ) Become WIA, for WIA(2+) or WIA(3+)**

Day	Dose Range	Day	Dose Range	Day	Dose Range
≥5	(none)	3	Stg2-B	1	Stg2-D
4	Stg2-A	2	Stg2-C		

\* This equates to the time at which all cohorts enter Stage 2 (Severity Level 3 for non-survivors and Severity Level 1 for survivors).

**Table 5-125: Dose-Dependent Day on Which Ricin Intoxication Non-Survivors ( $F_{Stg3-x}$ ) Enter Stage 3 of Illness**

Day	Dose Range	Day	Dose Range	Day	Dose Range
≥7	(none)	4	Stg3-C	1	Stg3-F
6	Stg3-A	3	Stg3-D		
5	Stg3-B	2	Stg3-E		

**Table 5-126: Dose-Dependent Day on Which Ricin Intoxication Non-Survivors ( $F_{DR}$ ) DOW**

Day	Dose Range	Day	Dose Range	Day	Dose Range	Day	Dose Range
≥11	(none)	8	DOW-C	5	DOW-F	2	DOW-I
10	DOW-A	7	DOW-D	4	DOW-G	1	DOW-J
9	DOW-B	6	DOW-E	3	DOW-H		

**Table 5-127: Daily Fraction of Ricin Intoxication Survivors (S) Who Become RTD**

Day	Fraction
≤8	0.0000
9	1.0000
≥10	0.0000

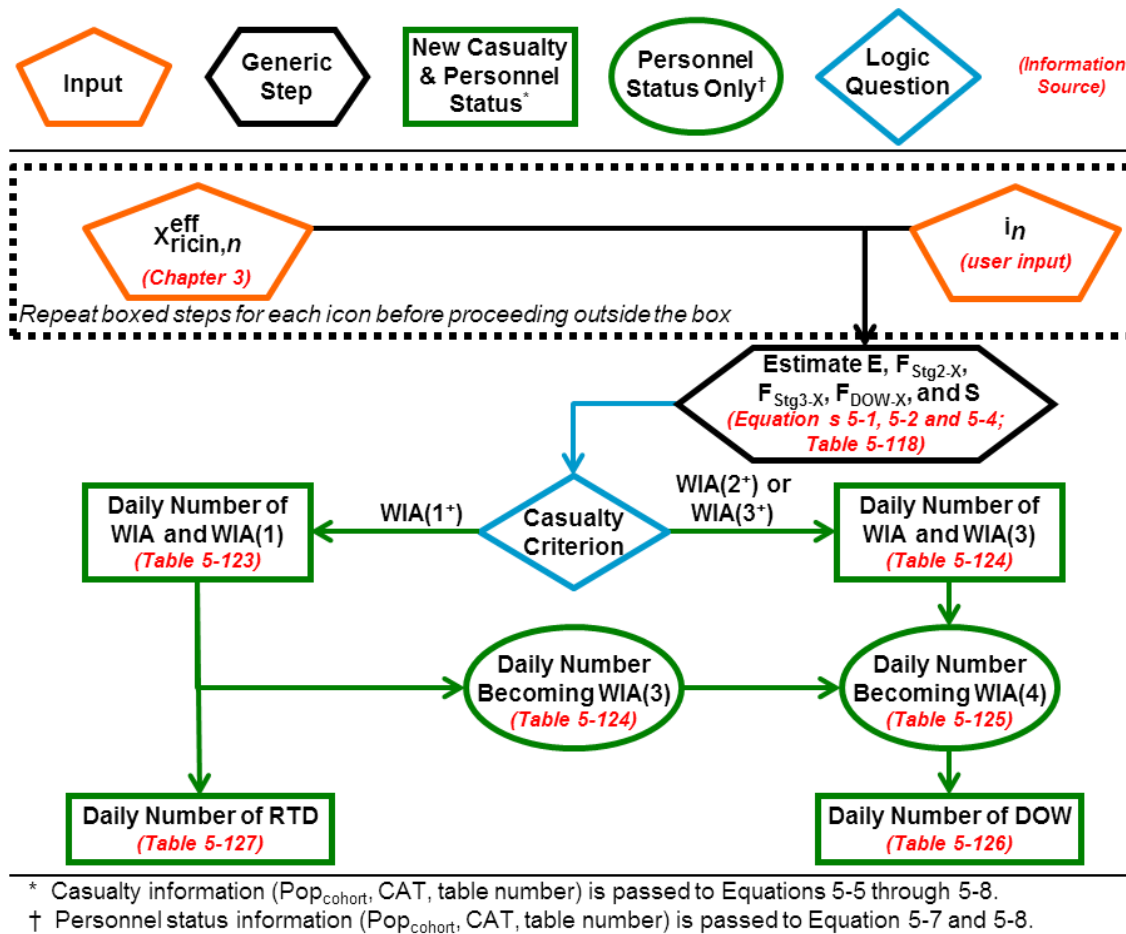

**Figure 5-15: Human Response and Casualty Estimation Flowchart for Ricin Intoxication**

**5.2.16. Staphylococcal Enterotoxin B (SEB) Intoxication**

1. Figure 5-16 summarizes the human response and casualty estimation processes for SEB intoxication, Table 5-129 summarizes the Injury Profile, and Table 5-130 summarizes the other SEB intoxication submodels. No prophylaxis is modeled for SEB intoxication.

2. Assumptions.

- a. All individuals are 70-kilogram males.
- b. The lethality probit slope is equal to the effectivity probit slope.

3. Cohorts and special considerations.

- a. Medical treatment has no effect on the submodel parameter values.
- b. The population of the E, F, and S cohorts are first calculated by applying

Equations 5-1, 5-2, and 5-4.

- c. The S cohort is then split into sub-cohorts labeled as  $S_{DR}$ , where DR is the dose range label given in Table 5-128. This is done due to the SEB intoxication Stage 1 duration of illness model for survivors being dose-dependent.

**Table 5-128: SEB Intoxication Dose Ranges for the  $S_{DR}$  Sub-Cohorts**

Dose Range Label (DR)	Dose Range [ $\mu\text{g}$ ]		Dose Range Label (DR)	Dose Range [ $\mu\text{g}$ ]	
	$X_{SEB,n}^{eff} >$	$X_{SEB,n}^{eff} \leq$		$X_{SEB,n}^{eff} >$	$X_{SEB,n}^{eff} \leq$
A	0	0.0240	E	0.2178	0.2824
B	0.0240	0.0886	F	0.2824	0.3471
C	0.0886	0.1532	G	0.3471	
D	0.1532	0.2178			

- 4. Table 5-131 through Table 5-134 are the PDTs for SEB. The values from a given table are to be used in Equations 5-5 through 5-8 with the cohort(s) listed in the table headers and footers, per Figure 5-16.

**Table 5-129: SEB Intoxication Injury Profile**

Stage	Injury Severity Level
Non-Survivors ( $F_{DR}$ )	
1	3
Survivors ( $S_{DR}$ )	
1	3
CONV	1

**Table 5-130: SEB Intoxication Submodel Summary**

Type	Value
<b>Effectivity (<math>p_E(X_{SEB,n}^{eff})</math>)</b>	
Lognormal Distribution	Use Equation 5-32 ED <sub>50</sub> = 0.026 $\mu\text{g}$ Probit slope = 2.54 probits/log(dose)
<b>Lethality (<math>p_f(X_{SEB,n}^{eff})</math>)</b>	
Lognormal Distribution	Use Equation 5-32 LD <sub>50</sub> = 1.66 $\mu\text{g}$ Probit slope = 2.54 probits/log(dose)
<b>Latent Period*</b>	
Constant	9 hours
<b>Duration of Illness*</b>	
Stage 1: Survivors ( $S_{DR}$ )	
Linear Function (capped at 7 days)	Dose-dependent: 1–7 days m = 15.4755 days/ $\mu\text{g}$ , b = 0.629 days
CONV: Survivors ( $S_{DR}$ )	
Constant	7 days
Stage 1: Non-Survivors (F)	
Constant	3 days

\* Presented for information only. These two submodels have already been convolved to generate the PDTs; the user should use the PDTs to estimate when changes in casualty category occur.

**Table 5-131: Daily Fraction of Individuals Ill with SEB Intoxication (E) Who Become WIA, for Any Casualty Criterion**

Day	Fraction
1	1.0000
≥2	0.0000

\* This equates to the time at which all cohorts enter Stage 1 (Severity Level 3).

**Table 5-132: Daily Fraction of SEB Intoxication Non-Survivors (F) who DOW**

Day	Fraction
≤3	0.0000
4	1.0000
≥5	0.0000

**Table 5-133: Daily Fraction of SEB Intoxication Survivors (S<sub>DR</sub>) Who Become CONV**

Day	Dose Range	Day	Dose Range	Day	Dose Range
≤1	(none)	4	C	7	F
2	A	5	D	8	G
3	B	6	E	≥9	(none)

**Table 5-134: Daily Fraction of SEB Intoxication Survivors (S<sub>DR</sub>) Who Become RTD**

Day	Dose Range	Day	Dose Range	Day	Dose Range
≤8	(none)	11	C	14	F
9	A	12	D	15	G
10	B	13	E	≥16	(none)

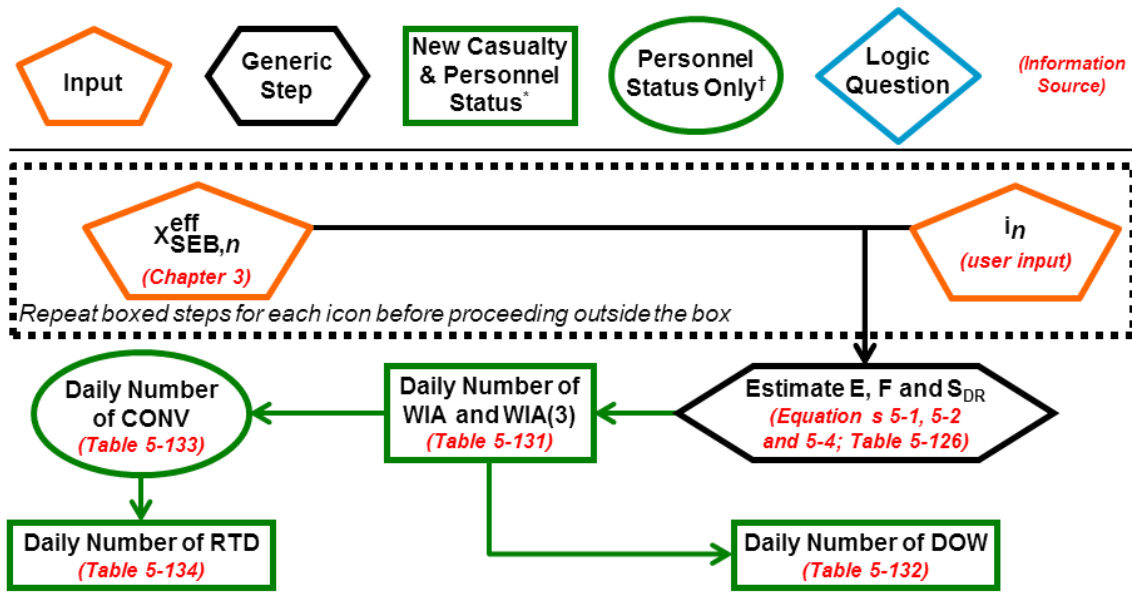

\* Casualty information (Pop<sub>cohort</sub>, CAT, table number) is passed to Equations 5-5 through 5-8.

† Personnel status information (Pop<sub>cohort</sub>, CAT, table number) is passed to Equation 5-7 and 5-8.

**Figure 5-16: Human Response and Casualty Estimation Flowchart for SEB Intoxication**

### 5.2.17. T-2 Mycotoxicosis

1. Figure 5-17 summarizes the human response and casualty estimation processes for T-2 mycotoxicosis, Table 5-135 summarizes the Injury Profile, and Table 5-136 summarizes the other T-2 mycotoxicosis submodels. No prophylaxis is modeled for T-2 mycotoxicosis.
2. Assumptions.
  - a. All individuals weigh 70 kilograms.
  - b. The effectivity probit slope is equal to the lethality probit slope.
3. Cohorts and special considerations.
  - a. Medical treatment has no effect on the submodel parameter values.
  - b. The E, F, and S cohorts are used; their populations are calculated by applying Equations 5-1, 5-2, and 5-4.
4. Table 5-137 through Table 5-140 are the PDTs for T-2 mycotoxicosis. The values from a given table are to be used in Equations 5-5 through 5-8 with the cohort(s) listed in the table headers and footers, per Figure 5-17.

**Table 5-135: T-2 Mycotoxicosis Injury Profile**

Stage	Injury Severity Level
Non-Survivors (F)	
1	2
2	3
3	4
Survivors (S)	
1	2
2	3

**Table 5-136: T-2 Mycotoxicosis Submodel Summary**

Type	Value
<b>Effectivity (<math>p_E(X_{T-2,n}^{eff})</math>)</b>	
Lognormal Distribution	Use Equation 5-32 ED <sub>50</sub> = 22.4 mg Probit slope = 4.3 probits/log(dose)
<b>Lethality (<math>p_f(X_{T-2,n}^{eff})</math>)</b>	
Lognormal Distribution	Use Equation 5-32 LD <sub>50</sub> = 28 mg Probit slope = 4.3 probits/log(dose)
<b>Latent Period*</b>	
Constant	4 hours
<b>Duration of Illness*</b>	
Stage 1: Non-Survivors (F) Stage 1: Survivors (S)	
Constant	8 hours
Stages 2 and 3 (each): Non-survivors (F)	
Constant	4 hours
Stage 2: Survivors (S)	
Constant	14 days

\* Presented for information only. These two submodels have already been convolved to generate the PDTs; the user should use the PDTs to estimate when changes in casualty category occur.

**Table 5-137: Daily Fraction of Individuals Ill with T-2 Mycotoxicosis (E) Who Become WIA, for WIA(1+) or WIA(2+)\***

Day	Fraction
1	1.0000
≥2	0.0000

\* This equates to the time at which all cohorts enter Stage 1 (Severity Level 2).

**Table 5-138: Daily Fraction of Individuals Ill with T-2 Mycotoxicosis (E) Who Become WIA, for WIA(3+)\***

Day	Fraction
1	1.0000
≥2	0.0000

\* This equates to the time at which all cohorts enter Stage 2 (Severity Level 3).

**Table 5-139: Daily Fraction of T-2 Mycotoxicosis Non-Survivors (F) Who DOW\***

Day	Fraction
1	1.0000
≥2	0.0000

\* This also equates to the time at which non-survivors enter Stage 3 (Severity Level 4).

**Table 5-140: Daily Fraction of T-2 Mycotoxicosis Survivors (S) Who Become RTD**

Day	Fraction
≤14	0.0000
15	1.0000
≥16	0.0000

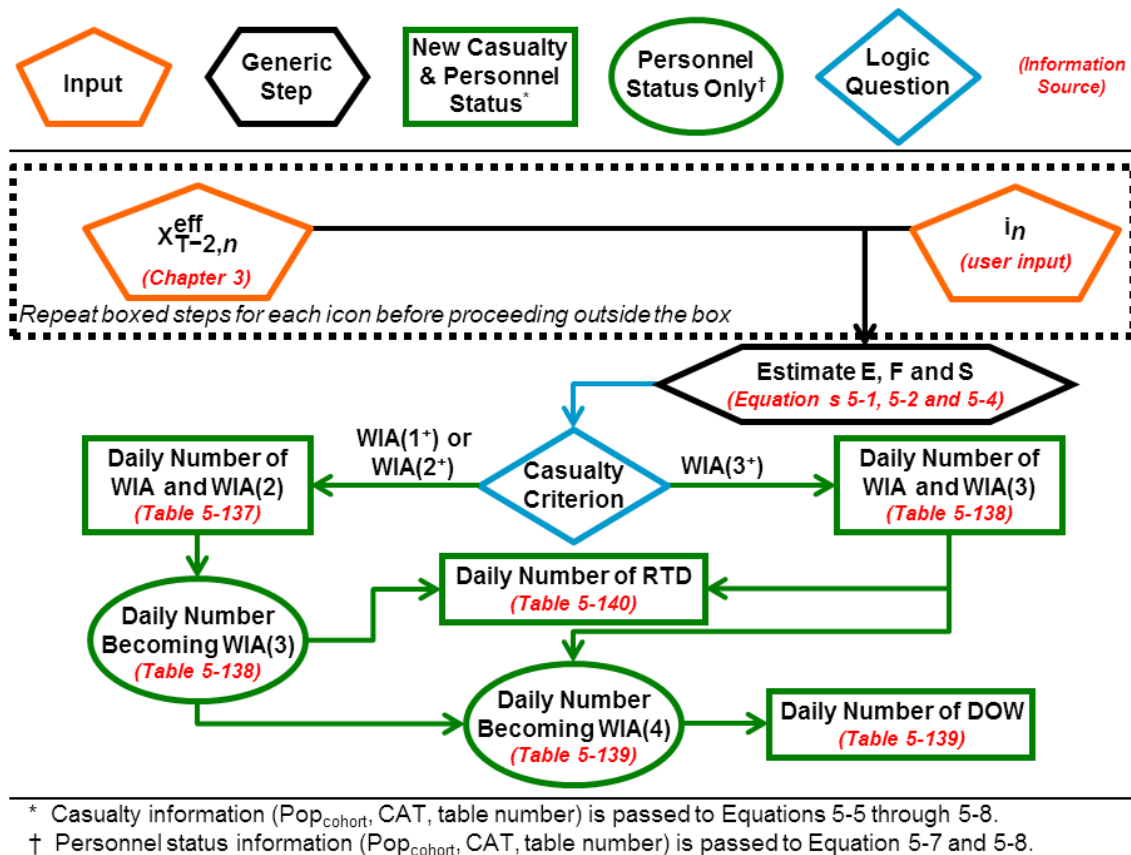

**Figure 5-17: Human Response and Casualty Estimation Flowchart for T-2 Mycotoxins**

**5.2.18. Ebola Virus Disease**

As noted in Section 1.3.1, this section presents some rough approximations of parameter values for EVD (Table 5-141).

**Table 5-141: Approximate EVD Parameter Values**

Parameter	Approximate Value or Range
Aerosol Infectivity	Highly infectious; ID <sub>50</sub> or threshold dose as low as < 10 PFU
Lethality	Dependent on strain and quality of medical care Including all known outbreaks, CFR range is ~25 to ~90%
Incubation Period	Mean: 5 to 13 days (strain dependent) Range: 2–21 days
Duration of Illness	Non-survivors: mean 6 to 10 days Survivors: mean 14 to 19 days of acute illness, possibly followed by months of convalescence (post-Ebola syndrome)



## CHAPTER 6 CASUALTY SUMMATION AND REPORTING

This chapter explains how the methodology's outputs meet the requirements of AJP-4.10, and how the casualty estimate tables are generated from the outputs of Chapters 4 and 5. For specific guidance on how the outputs might be used, see AMedP-7.6. For additional operational, logistic, and medical planning considerations that may be affected by CBRN casualty estimates, see AJP-5, AJP-4, and AJP-4.10, respectively.

### 6.1. APPLICATION OF AJP-4.10 REQUIREMENTS

1. As stated in AJP-4.10, the casualty estimation process should generate four outputs: population at risk (PAR), casualty rates, casualty flow, and casualty profile.
2. In this methodology, the PAR is simply the total number of personnel included in the scenario, which is defined by user input and calculated according to Equation 6-1. The user's determination of which personnel should be included in a scenario should be guided by operational and medical considerations; AMedP-7.6 provides guidance on choosing the PAR.

$$\text{PAR} = \sum_n i_n, \quad (6-1)$$

where  $i_n$  is the number of individuals in icon  $n$ .

3. The casualty rate is concerned with the number of *new* casualties of each type per day. This methodology produces one table reporting the rate of new casualties, and an additional table, the personnel status table, that lists the *total* number of casualties reported in each category on each day.
4. The flow characterizes the movement between casualty categories.<sup>91</sup> The casualty flow is depicted within the output tables; a separate table presenting the flow would be redundant.
5. The profile is a description of the relative proportions of types of injuries that relate to an individual's casualty category. Profiles are presented within the output tables. Because different planning considerations are relevant for each casualty category, each category has a unique set of "compartments" that are used to describe the profile. See Table 6-1 for a summary of the compartments and the list below for explanation.

---

<sup>91</sup> AJP-4.10 also describes flow as characterizing the timing of casualty waves. This is dependent on when incidents occur, which is beyond the purview of this methodology.

- a. For KIA and DOW, the planning consideration is whether the human remains require special handling that would affect the operations of Mortuary Affairs. KIAs might be contaminated with chemical (C) or radiological materials (R or N), so the possible compartments are C, R, or N. DOWs might be biohazards (B) or might be uncontaminated<sup>92</sup> (CRN).
- b. For WIA and CONV, the planning consideration is the medical resources required to care for the casualty. Thus, for the rate table, WIAs are reported based on challenge type (e.g., WIA(GB) or WIA(anthrax)), and for the personnel status table, WIAs are reported based on both challenge type and injury severity (e.g., GB(4) or anthrax(2) within the WIA section of the table). CONV is reported only by the challenge (e.g., CONV(VX)).
- c. RTD is not divided into compartments because, by definition, RTD personnel are capable of resuming normal duties.

**Table 6-1: Compartments for Reporting Casualty Profile**

Casualty Category	Basis for Compartment Names, or Specific Compartment Names
WIA	<i>Basis for names:</i> challenge and Injury Severity Level
KIA	<i>Specific names:</i> chemical (C), radiological (R), or nuclear (N)
DOW	<i>Specific names:</i> biological (B) or chemical/radiological/nuclear (CRN)
CONV	<i>Basis for names:</i> challenge
RTD	None

## 6.2. DESCRIPTION OF OUTPUT REPORTING

1. The casualty estimate is reported with a time resolution of one day. This time resolution is not user-tunable. Daily reporting continues until no more changes in casualty category occur.
2. As the rate table reports only *new* casualties, a casualty reported as WIA will not be reported again until s/he becomes DOW, CONV, or RTD. As the rate table *cannot* track subsequent changes in Injury Severity Level after an individual initially becomes WIA, it does not include the Injury Severity Level for WIAs.
3. The personnel status table gives the *total number* of casualties reported in each category on each day. As the personnel status table *can* track subsequent changes in Injury Severity Level, it does report WIAs as WIA(#).
  - a. As casualties never leave the KIA, DOW, or RTD categories, the counts in the personnel status table are the cumulative number over time.
  - b. As casualties can leave the WIA and CONV categories, the counts in the personnel status table are the total on a given day, and over time the totals

<sup>92</sup> Chemical and radiological casualties are assumed to be decontaminated prior to entering an MTF.

might peak and then decrease back to zero. When  $\text{Flag}_{\text{MT}} = \text{NO}$ , the WIA totals might not decrease to zero (depending on the challenge type). Finally, for challenge types that produce permanent or indefinite CONV, CONV will not decrease to zero.

4. Because it is possible for an individual to be assigned to multiple casualty categories within a *single* day, the reporting rules from Table 1-4 are followed to facilitate more appropriate resource planning and to avoid double-counting. Adherence to these rules is built into the models described in Chapters 4 and 5.

5. For nuclear casualties, the simultaneous occurrence of radiation, blast, and thermal injuries creates a complication in determining 1) the fraction of casualties moving from one casualty category to another and 2) when those casualties change categories. The same issue may arise for VX, HD, CG, CK, RDDs, and fallout casualties when  $\text{Flag}_{\text{MT}} = \text{Yes}$ , because MTORs do not make use of Composite Injury Profiles, but each casualty may nevertheless be following more than one Injury Profile; the MTOR table would therefore indicate two different outcomes that must be deconflicted.

- a. Table 6-2 shows how to report casualty category when multiple Injury Profiles indicate different casualty categories.

**Table 6-2: Casualty Category Reporting Rules for Multiple Injury Profiles**

Injury Profile 1 Category	Injury Profile 2+ Category	Overall Reported Category
DOW	DOW/WIA/CONV/RTD	DOW
WIA	WIA/CONV/RTD	WIA
CONV	CONV/RTD	CONV
RTD	RTD	RTD

- b. The following rules specify how personnel following multiple Injury Profiles are split among multiple potential outcomes.
  - 1) DOW: The overall percentage of individuals categorized as DOW is the maximum percentage categorized as DOW from all the individual Injury Profiles.
  - 2) WIA: The overall percentage of individuals categorized as WIA is the minimum of either 1) the maximum percentage categorized as WIA from the individual Injury Profiles or 2) 100% minus the overall percentage of individuals categorized as DOW.
  - 3) CONV: The overall percentage of individuals categorized as CONV is zero if either 1) the sum of the overall percentages of individuals categorized as either DOW or WIA is 100% or 2) the percentages of individuals categorized as CONV from the individual Injury Profiles are all zero. Otherwise, the overall percentage of individuals categorized as CONV is the greater of 1) the minimum nonzero percentage of individuals categorized as either CONV or RTD in any of the individual Injury Profiles

or 2) 100% minus the sum of the overall percentages of individuals categorized as either DOW or WIA.

- 4) RTD: The overall percentage of individuals categorized as RTD is 100% minus the sum of the overall percentages of individuals categorized as DOW, WIA, or CONV.

6. Table 6-3 and Table 6-4 are example output tables. Note that for any particular incident, the tables may look different, per the following considerations.

- a. The specific compartment labels are different for different challenge types (as specified in Table 6-1).
- b. For brevity, rows that have 0 population on every day can be excluded.
  - 1) In the personnel status table, WIA(#) rows can be excluded if the challenge type never causes injuries of that Injury Severity Level.
  - 2) If there are no KIA, no DOW, no CONV, or no RTD, those rows can also be excluded.
- c. A unique personnel status table is used for reporting nuclear casualties (see Section 6.3), to account for the simultaneous occurrence of radiation, blast, and thermal injuries, and the need to separately track different types of injury to facilitate medical planning.

**Table 6-3: Estimated Daily Number of New (Challenge) Casualties\***

Casualty Description	Day 1	Day 2	Day 3	Day 4	Day 5	Day 6	Day 7	Day 8	Day 9	Day	Day X
New KIA (C, R, or N)											
New DOW (CRN or B)											
Sum of New Fatalities											
New WIA (Challenge)											
New CONV (Challenge)											
New RTD											

\* Estimate is based on Casualty Criterion WIA(X+), a PAR of Y, and Flag<sub>MT</sub> = Yes/No.

**Table 6-4: Estimated Personnel Status for (Challenge) Casualties\***

Casualty Description	Day 1	Day 2	Day 3	Day 4	Day 5	Day 6	Day 7	Day 8	Day 9	Day	Day X
Fatalities											
KIA (C, R, or N)											
DOW (CRN or B)											
Sum of Fatalities											
WIA											
Challenge(1)											
Challenge(2)											
Challenge(3)											
Challenge(4)											
Sum of WIA											
CONV											
CONV (Challenge)											
RTD											
RTD											

\* Estimate is based on Casualty Criterion WIA(X<sup>+</sup>), a PAR of Y, and Flag<sub>MT</sub> = Yes/No.

7. Chapters 4 and 5 provide the daily numbers of reported new casualties in each casualty category, to be entered in Table 6-3.

- a. For chemical casualties, Equation 4-17 provides the daily numbers.
- b. For radiological and nuclear casualties, Equation 4-18 provides the daily numbers.
- c. For non-contagious biological casualties, Equations 5-5 and 5-6 provide the daily numbers.
- d. For contagious biological casualties, Table 5-3 lists the equations to be used to provide the daily numbers.

8. Chapters 4 and 5 also provide the information needed to fill in the personnel status table, Table 6-4.

- a. For chemical casualties, Equation 4-19 provides the daily numbers.
- b. For radiological and nuclear casualties, Equation 4-20 provides the daily numbers.
- c. For non-contagious biological casualties, Equations 5-7 and 5-8 provide the daily numbers.
- d. For contagious biological casualties, Table 5-3 lists the equations to be used to provide the daily numbers.

9. A user interested in modeling multiple simultaneous incidents must run the

model separately for each incident and perform custom post-processing to combine the results.

- a. If the incidents are all radiological or nuclear (for example, nuclear detonation and fallout), the icon-specific nature of the human response models will facilitate combining the results without any double-counting issues. Thus, generating casualty rate tables will be straightforward. However, a special version of the personnel status table should be used instead of Table 6-4—see Section 6.3.
- b. If at least one of the multiple incidents is chemical or biological, double-counting some individuals and failing to account for other individuals will be unavoidable because of the population-based nature of the models.

### 6.3. PERSONNEL STATUS TABLE FOR NUCLEAR CASUALTIES

1. Although the methodology cannot account for synergy between radiation (R), blast (B), and thermal (T) challenges, it can produce a single *report* of casualties from the three prompt nuclear effects. The method is outlined here, and a specific example is given in Section A.6.

2. For each icon, the flowcharts for radiation (Figure 4-17), blast (Figure 4-18), and thermal (Figure 4-19) injury must be consulted, and the results combined according to Table 6-2 and the guidance in paragraph 6.2.5.b. Some additional guidance specific to nuclear is included below.

- a. If any of the three flowcharts indicates KIA, the icon should be reported as KIA on day 1.
- b. Any icon that is WIA but not KIA should be reported as WIA on day 1, with the maximum severity of all three injuries on day 1 included. For example, (R2, B3, T2). Thus, the personnel status table will have up to 125 WIA rows (see Table 6-5). In most situations, many rows can be excluded from the table because their populations will be zero.
- c. As indicated by the flowcharts, for days after day 1, an icon's casualty status might be updated for one of several reasons.
  - 1) Change in maximum severity of at least one of the three individual injuries—moves to a different WIA row. This can occur every day.
  - 2) Casualty becomes DOW—moves from a WIA row to the DOW row. This occurs at the *earliest* time that any of the three flowcharts indicates.
  - 3) Casualty becomes CONV—moves from a WIA row to a CONV row. This occurs at the *latest* time that any of the three flowcharts indicates.

4) Casualty becomes RTD—moves from a WIA row to the RTD row. This occurs at the *latest* time that any of the three flowcharts indicates.

4. Icons should only be reported as CONV for a single injury type if only one of the three medical treatment outcome reporting table indicates CONV. For example, if an icon receives R, B, and T injuries, and the B and T medical treatment outcome reporting tables indicate RTD, but the R table indicates CONV, that icon should be reported as CONV (R), *not* CONV (R, B, T).

5. Table 6-5 is an example personnel status table for nuclear casualties. It should be used instead of Table 6-4.

**Table 6-5: Estimated Personnel Status for Nuclear Casualties\***

Casualty Description	Day 1	Day 2	Day 3	Day 4	Day 5	Day 6	Day 7	Day 8	Day 9	Day ...	Day X
Fatalities											
KIA—N											
DOW—CRN											
Sum of Fatalities											
WIA <sup>†</sup>											
R0 <sup>4.5–8.3 Gy</sup> , B0, T0 <sup>§</sup>											
R0, B0, T1											
R0, B0, T2											
R0, B0, T3											
R0, B0, T4											
R0, B1, T0											
R0, B1, T1											
R0, B1, T2											
R0, B1, T3											
R0, B1, T4											
R0, B2, T0											
R0, B2, T1											
R0, B2, T2											
R0, B2, T3											
R0, B2, T4											
R0, B3, T0											
R0, B3, T1											
R0, B3, T2											
R0, B3, T3											
R0, B3, T4											
R0, B4, T0											
R0, B4, T1											
R0, B4, T2											
R0, B4, T3											
R0, B4, T4											
R1, B0, T0											

Casualty Description	Day 1	Day 2	Day 3	Day 4	Day 5	Day 6	Day 7	Day 8	Day 9	Day ...	Day X
R1, B0, T1											
R1, B0, T2											
R1, B0, T3											
R1, B0, T4											
R1, B1, T0											
R1, B1, T1											
R1, B1, T2											
R1, B1, T3											
R1, B1, T4											
R1, B2, T0											
R1, B2, T1											
R1, B2, T2											
R1, B2, T3											
R1, B2, T4											
R1, B3, T0											
R1, B3, T1											
R1, B3, T2											
R1, B3, T3											
R1, B3, T4											
R1, B4, T0											
R1, B4, T1											
R1, B4, T2											
R1, B4, T3											
R1, B4, T4											
R2, B0, T0											
R2, B0, T1											
R2, B0, T2											
R2, B0, T3											
R2, B0, T4											
R2, B1, T0											
R2, B1, T1											
R2, B1, T2											
R2, B1, T3											
R2, B1, T4											
R2, B2, T0											
R2, B2, T1											
R2, B2, T2											
R2, B2, T3											
R2, B2, T4											
R2, B3, T0											
R2, B3, T1											
R2, B3, T2											
R2, B3, T3											



Casualty Description	Day 1	Day 2	Day 3	Day 4	Day 5	Day 6	Day 7	Day 8	Day 9	Day ...	Day X
R2, B3, T4											
R2, B4, T0											
R2, B4, T1											
R2, B4, T2											
R2, B4, T3											
R2, B4, T4											
R3, B0, T0											
R3, B0, T1											
R3, B0, T2											
R3, B0, T3											
R3, B0, T4											
R3, B1, T0											
R3, B1, T1											
R3, B1, T2											
R3, B1, T3											
R3, B1, T4											
R3, B2, T0											
R3, B2, T1											
R3, B2, T2											
R3, B2, T3											
R3, B2, T4											
R3, B3, T0											
R3, B3, T1											
R3, B3, T2											
R3, B3, T3											
R3, B3, T4											
R3, B4, T0											
R3, B4, T1											
R3, B4, T2											
R3, B4, T3											
R3, B4, T4											
R4, B0, T0											
R4, B0, T1											
R4, B0, T2											
R4, B0, T3											
R4, B0, T4											
R4, B1, T0											
R4, B1, T1											
R4, B1, T2											
R4, B1, T3											
R4, B1, T4											
R4, B2, T0											
R4, B2, T1											

Casualty Description	Day 1	Day 2	Day 3	Day 4	Day 5	Day 6	Day 7	Day 8	Day 9	Day ...	Day X
R4, B2, T2											
R4, B2, T3											
R4, B2, T4											
R4, B3, T0											
R4, B3, T1											
R4, B3, T2											
R4, B3, T3											
R4, B3, T4											
R4, B4, T0											
R4, B4, T1											
R4, B4, T2											
R4, B4, T3											
R4, B4, T4											
<b>Sum of WIA</b>											
<b>CONV†</b>											
CONV (R)											
CONV (B)											
CONV (T)											
CONV (R, B)											
CONV (R, T)											
CONV (B, T)											
CONV (R, B, T)											
<b>Sum of CONV</b>											
<b>RTD</b>											
<b>RTD</b>											

\* Estimate is based on Casualty Criterion WIA(X+) and a PAR of Y.

† Any row that has a population of zero should be excluded from the table.

§ This row is for untreated individuals in the 4.5 – 8.3 Gy whole-body radiation dose range who either sustained no thermal or blast injury, or have recovered from thermal or blast injuries; for the period between 72 and 96 hours, the radiation Injury Severity Level will be 0, but the Injury Severity Level will increase again at 96 hours, so the individuals cannot be RTD.

<b>ANNEX A      ILLUSTRATIVE EXAMPLES</b>
---

## **A.1. OVERVIEW**

1. This annex provides a set of six examples designed to act as a guide for the application of the methodology. Included are two chemical agents examples (GB and CK), one radiological example (a  $^{137}\text{Cs}$  RDD)<sup>93</sup>, a nuclear effects example (10 kT ground burst), and two biological agent examples (one non-contagious (anthrax) and one contagious (smallpox)).
2. For simplicity, the examples use a common force layout, described in Section A.2., which fulfills part of the INPUT step: it defines the icons and most of the icon attributes.
3. Next are the six illustrative examples (Sections A.3 through A.8), which each define a unique CBRN incident, and then walk through the remainder of the INPUT step and the CHALLENGE, RESPONSE, STATUS, and REPORT steps. The discussion of the five major steps for each example also includes finer detail on the methodological steps.

## **A.2. INPUT (ALL ILLUSTRATIVE EXAMPLES)**

1. The illustrative examples will use Input Scheme 1 (see Figure 1-3).
2. Table 1-5 shows that for every agent, effect, or disease, Chapter 2 describes how to complete the INPUT step of the methodology. All INPUT other than the CBRN Challenge per icon over time is provided in this section (A.2); the CBRN Challenge information will be provided individually for each scenario (in Sections A.3 through A.8).
3. The following steps are necessary before the input described in Chapter 2 can be provided:
  - a. Define the layout of forces, grouping of individuals into icons, and values of icon attributes over time. This is done in Section A.2.1, specifically Table A-1.
  - b. Define a CBRN threat and model the CBRN incident. For the illustrative examples, this modeling has been done using specific U.S. software; in general, however, any national software or method that provides suitable output (Section 2.1.2 defines what is suitable) can be used. As mentioned, this step is different for each scenario, and will be discussed in Sections A.3

---

<sup>93</sup> Methodologically, fallout and RDDs are almost identical, so a fallout example is unnecessary.

through A.8

### A.2.1. Icons and Icon Attributes

1. The layout of forces is pictured in Figure A-1 and described in greater detail in Table A-1. The 816 personnel in the scenario are represented by 155 icons; it is an entirely notional force arranged as if guarding an airstrip (represented by the white space in the middle of the icons). A variety of vehicles and structures are listed in Table A-1 for the purpose of demonstrating the allowable variability among icons in a single scenario. The illustrative scenario is not meant to represent any real operation. The group of individuals represented by the icons will be referred to as the “task force”.

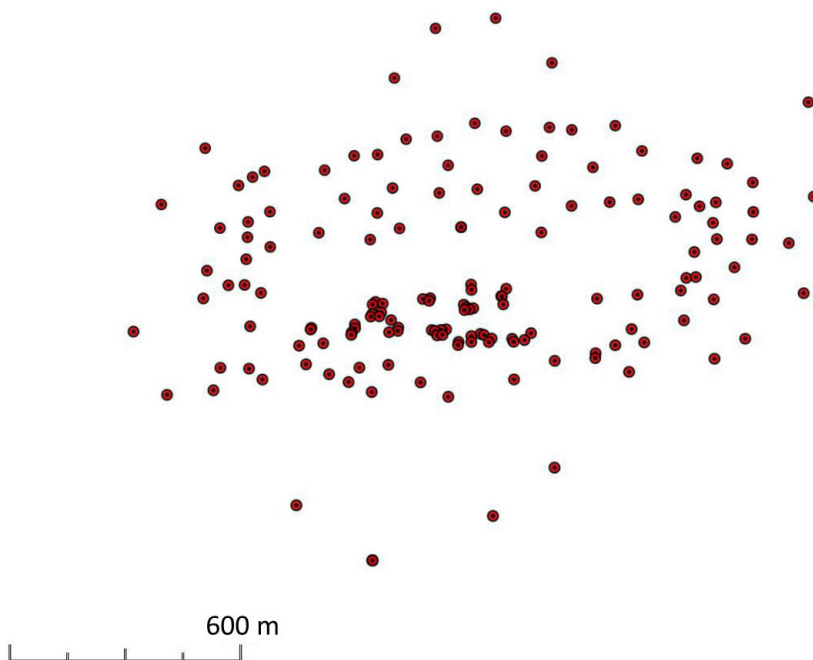

**Figure A-1: Layout of Icons**

2. Each of the 155 icons is assigned icon attributes per Table A-1. For the sake of simplicity, in five of the six illustrative examples these values will not change over time. However, to demonstrate how to handle changing icon attributes, the anthrax example will involve personnel initially not wearing IPE (masks), but then donning masks partway through the scenario (affects the CHALLENGE step).

3. The only other icon-specific information needed is the CBRN Challenge per icon over time, the values of which are provided Sections A.3 to A.8. The specific U.S. tools that were used to generate the CBRN Challenge per icon over time for the scenarios are listed below. These tools may not be available to other nations, and are

not required to execute AMedP-7.5; each nation should use its own national method of estimating CBRN challenge.

- a. For all examples other than nuclear, the data were extracted from the results of simulations performed by the U.S. government software “Hazard Prediction and Assessment Capability” (HPAC), version 5.3.226 with Patch 3.<sup>94</sup> Each icon was represented by an HPAC sampler; the type of sampler was specified so that data extracted from HPAC could be converted to the appropriate units for AMedP-7.5.
- b. For the nuclear example, the radiation challenge was estimated according to Version 6 of Air Transport of Radiation (ATR6),<sup>95</sup> and the thermal and blast challenges were estimated according to *Calculational Tools Abstracted from DTRA’s Effects Manual One (EM-1)*.<sup>96</sup>

---

<sup>94</sup> "Hazard Prediction and Assessment Capability," version 5.3.226 with Patch 3 (Defense Threat Reduction Agency, 2015).

<sup>95</sup> F. Dolatshahi, D. C. Kaul, and W. A. Woolson, *Technical and User’s Manual, Fortran Edition, Version 6 of Air Transport of Radiation (ATR6)*, SAIC-90/1507, DNA-TR-91-165 (La Jolla, CA: Science Applications International Corporation, 1992).

<sup>96</sup> John A. Northrop, ed. *Handbook of Nuclear Weapon Effects: Calculational Tools Abstracted from DTRA’s Effects Manual One (EM-1)* (Ft. Belvoir, VA: Defense Threat Reduction Agency, 2002).

**INTENTIONALLY BLANK**

**Table A-1: User Input for Illustrative Examples Tactical Scenario**

See Section:	2.1.3	2.1.4	2.1.5	2.1.6	2.1.6	4.4.4	4.4.4	4.4.4	
Icon #	# Personnel	Activity Level	Body Surface Area	IPE Class	Vehicle/Shelter Information			Icon Warned?	Uniform Type
					Ventilation Class	Radiation Class	Thermal class		
1	4	Moderate	0.9 m <sup>2</sup>	None	Shelter w/ColPro	Tent	Tent	No	BDU+T-shirt
2	4	Moderate	0.9 m <sup>2</sup>	None	Shelter w/ColPro	Tent	Tent	No	BDU+T-shirt
3	1	At Rest	0.9 m <sup>2</sup>	Mask	Residential Building – Open Windows	Wood Frame Building	Wood Frame Building	No	BDU+T-shirt
4	4	Moderate	0.9 m <sup>2</sup>	None	Shelter w/ColPro	Tent	Tent	No	BDU+T-shirt
5	1	At Rest	0.9 m <sup>2</sup>	Mask	Residential Building – Open Windows	Wood Frame Building	Wood Frame Building	No	BDU+T-shirt
6	7	Moderate	0.9 m <sup>2</sup>	Mask	None	Foxhole	Foxhole	No	BDU+T-shirt
7	7	Moderate	0.9 m <sup>2</sup>	Mask	None	Foxhole	Foxhole	No	BDU+T-shirt
8	7	Moderate	0.9 m <sup>2</sup>	Mask	None	Exposed/ Dismounted	Exposed/ Dismounted	No	BDU+T-shirt
9	7	Moderate	0.9 m <sup>2</sup>	Mask	None	Exposed/ Dismounted	Exposed/ Dismounted	No	BDU+T-shirt
10	7	Moderate	0.9 m <sup>2</sup>	Mask	None	Exposed/ Dismounted	Exposed/ Dismounted	No	BDU+T-shirt
11	7	Moderate	0.9 m <sup>2</sup>	Mask	None	Foxhole	Foxhole	No	BDU+T-shirt
12	7	Moderate	0.9 m <sup>2</sup>	Mask	None	Foxhole	Foxhole	No	BDU+T-shirt
13	7	Moderate	0.9 m <sup>2</sup>	Mask	None	Exposed/ Dismounted	Exposed/ Dismounted	No	BDU+T-shirt
14	7	Moderate	0.9 m <sup>2</sup>	Mask	None	Foxhole	Foxhole	No	BDU+T-shirt
15	7	Moderate	0.9 m <sup>2</sup>	Mask	None	Foxhole	Foxhole	No	BDU+T-shirt
16	7	Moderate	0.9 m <sup>2</sup>	Mask	None	Foxhole	Foxhole	No	BDU+T-shirt
17	7	Moderate	0.9 m <sup>2</sup>	Mask	None	Exposed/ Dismounted	Exposed/ Dismounted	No	BDU+T-shirt
18	7	Moderate	0.9 m <sup>2</sup>	Mask	None	Foxhole	Foxhole	No	BDU+T-shirt
19	7	Moderate	0.9 m <sup>2</sup>	Mask	None	Exposed/ Dismounted	Exposed/ Dismounted	No	BDU+T-shirt
20	7	Moderate	0.9 m <sup>2</sup>	Mask	None	Foxhole	Foxhole	No	BDU+T-shirt

**ANNEX A TO  
AMedP-7.5**

See Section:		2.1.3	2.1.4	2.1.5	2.1.6	2.1.6	4.4.4	4.4.4	4.4.4
Icon #	# Personnel	Activity Level	Body Surface Area	IPE Class	Vehicle/Shelter Information				
					Ventilation Class	Radiation Class	Thermal class	Icon Warned?	Uniform Type
21	7	Moderate	0.9 m <sup>2</sup>	Mask	None	Exposed/ Dismounted	Exposed/ Dismounted	No	BDU+T-shirt
22	7	Moderate	0.9 m <sup>2</sup>	Mask	None	Exposed/ Dismounted	Exposed/ Dismounted	No	BDU+T-shirt
23	7	Moderate	0.9 m <sup>2</sup>	Mask	None	Exposed/ Dismounted	Exposed/ Dismounted	No	BDU+T-shirt
24	7	Moderate	0.9 m <sup>2</sup>	Mask	None	Foxhole	Foxhole	No	BDU+T-shirt
25	7	Moderate	0.9 m <sup>2</sup>	Mask	None	Foxhole	Foxhole	No	BDU+T-shirt
26	7	Moderate	0.9 m <sup>2</sup>	Mask	None	Exposed/ Dismounted	Exposed/ Dismounted	No	BDU+T-shirt
27	7	Moderate	0.9 m <sup>2</sup>	Mask	None	Exposed/ Dismounted	Exposed/ Dismounted	No	BDU+T-shirt
28	7	Moderate	0.9 m <sup>2</sup>	Mask	None	Foxhole	Foxhole	No	BDU+T-shirt
29	7	Moderate	0.9 m <sup>2</sup>	Mask	None	Foxhole	Foxhole	No	BDU+T-shirt
30	7	Moderate	0.9 m <sup>2</sup>	Mask	None	Exposed/ Dismounted	Exposed/ Dismounted	No	BDU+T-shirt
31	7	Moderate	0.9 m <sup>2</sup>	Mask	None	Exposed/ Dismounted	Exposed/ Dismounted	No	BDU+T-shirt
32	7	Moderate	0.9 m <sup>2</sup>	Mask	None	Foxhole	Foxhole	No	BDU+T-shirt
33	7	Moderate	0.9 m <sup>2</sup>	Mask	None	Exposed/ Dismounted	Exposed/ Dismounted	No	BDU+T-shirt
34	7	Moderate	0.9 m <sup>2</sup>	Mask	None	Foxhole	Foxhole	No	BDU+T-shirt
35	7	Moderate	0.9 m <sup>2</sup>	Mask	None	Exposed/ Dismounted	Exposed/ Dismounted	No	BDU+T-shirt
36	7	Moderate	0.9 m <sup>2</sup>	Mask	None	Exposed/ Dismounted	Exposed/ Dismounted	No	BDU+T-shirt
37	7	Moderate	0.9 m <sup>2</sup>	Mask	None	Foxhole	Foxhole	No	BDU+T-shirt
38	7	Moderate	0.9 m <sup>2</sup>	Mask	None	Foxhole	Foxhole	No	BDU+T-shirt
39	7	Moderate	0.9 m <sup>2</sup>	Mask	None	Foxhole	Foxhole	No	BDU+T-shirt
40	7	Moderate	0.9 m <sup>2</sup>	Mask	None	Exposed/ Dismounted	Exposed/ Dismounted	No	BDU+T-shirt



**ANNEX A TO  
AMedP-7.5**

See Section:		2.1.3	2.1.4	2.1.5	2.1.6	2.1.6	4.4.4	4.4.4	4.4.4
Icon #	# Personnel	Activity Level	Body Surface Area	IPE Class	Vehicle/Shelter Information				
					Ventilation Class	Radiation Class	Thermal class	Icon Warned?	Uniform Type
41	7	Moderate	0.9 m <sup>2</sup>	Mask	None	Foxhole	Foxhole	No	BDU+T-shirt
42	7	Moderate	0.9 m <sup>2</sup>	Mask	None	Exposed/ Dismounted	Exposed/ Dismounted	No	BDU+T-shirt
43	7	Moderate	0.9 m <sup>2</sup>	Mask	None	Foxhole	Foxhole	No	BDU+T-shirt
44	7	Moderate	0.9 m <sup>2</sup>	Mask	None	Exposed/ Dismounted	Exposed/ Dismounted	No	BDU+T-shirt
45	7	Moderate	0.9 m <sup>2</sup>	Mask	None	Foxhole	Foxhole	No	BDU+T-shirt
46	7	Moderate	0.9 m <sup>2</sup>	Mask	None	Foxhole	Foxhole	No	BDU+T-shirt
47	7	Moderate	0.9 m <sup>2</sup>	Mask	None	Foxhole	Foxhole	No	BDU+T-shirt
48	7	Moderate	0.9 m <sup>2</sup>	Mask	None	Exposed/ Dismounted	Exposed/ Dismounted	No	BDU+T-shirt
49	7	Moderate	0.9 m <sup>2</sup>	Mask	None	Foxhole	Foxhole	No	BDU+T-shirt
50	7	Moderate	0.9 m <sup>2</sup>	Mask	None	Exposed/ Dismounted	Exposed/ Dismounted	No	BDU+T-shirt
51	7	Moderate	0.9 m <sup>2</sup>	Mask	None	Foxhole	Foxhole	No	BDU+T-shirt
52	7	Moderate	0.9 m <sup>2</sup>	Mask	None	Foxhole	Foxhole	No	BDU+T-shirt
53	7	Moderate	0.9 m <sup>2</sup>	Mask	None	Exposed/ Dismounted	Exposed/ Dismounted	No	BDU+T-shirt
54	7	Moderate	0.9 m <sup>2</sup>	Mask	None	Exposed/ Dismounted	Exposed/ Dismounted	No	BDU+T-shirt
55	7	Moderate	0.9 m <sup>2</sup>	Mask	None	Exposed/ Dismounted	Exposed/ Dismounted	No	BDU+T-shirt
56	7	Heavy	0.9 m <sup>2</sup>	Mask	None	Exposed/ Dismounted	Exposed/ Dismounted	No	BDU+T-shirt
57	7	Heavy	0.9 m <sup>2</sup>	Mask	None	Exposed/ Dismounted	Exposed/ Dismounted	No	BDU+T-shirt
58	7	Moderate	0.9 m <sup>2</sup>	Mask	None	Foxhole	Foxhole	No	BDU+T-shirt
59	7	Heavy	0.9 m <sup>2</sup>	Mask	None	Exposed/ Dismounted	Exposed/ Dismounted	No	BDU+T-shirt
60	7	Moderate	0.9 m <sup>2</sup>	Mask	None	Foxhole	Foxhole	No	BDU+T-shirt

**ANNEX A TO  
AMedP-7.5**

See Section:		2.1.3	2.1.4	2.1.5	2.1.6	2.1.6	4.4.4	4.4.4	4.4.4
Icon #	# Personnel	Activity Level	Body Surface Area	IPE Class	Vehicle/Shelter Information				
					Ventilation Class	Radiation Class	Thermal class	Icon Warned?	Uniform Type
61	7	Moderate	0.9 m <sup>2</sup>	Mask	None	Exposed/ Dismounted	Exposed/ Dismounted	No	BDU+T-shirt
62	7	Moderate	0.9 m <sup>2</sup>	Mask	None	Foxhole	Foxhole	No	BDU+T-shirt
63	7	Moderate	0.9 m <sup>2</sup>	Mask	None	Exposed/ Dismounted	Exposed/ Dismounted	No	BDU+T-shirt
64	7	Moderate	0.9 m <sup>2</sup>	Mask	None	Foxhole	Foxhole	No	BDU+T-shirt
65	7	Moderate	0.9 m <sup>2</sup>	Mask	None	Exposed/ Dismounted	Exposed/ Dismounted	No	BDU+T-shirt
66	7	Moderate	0.9 m <sup>2</sup>	Mask	None	Foxhole	Foxhole	No	BDU+T-shirt
67	7	Moderate	0.9 m <sup>2</sup>	Mask	None	Foxhole	Foxhole	No	BDU+T-shirt
68	7	Moderate	0.9 m <sup>2</sup>	Mask	None	Exposed/ Dismounted	Exposed/ Dismounted	No	BDU+T-shirt
69	7	Moderate	0.9 m <sup>2</sup>	Mask	None	Exposed/ Dismounted	Exposed/ Dismounted	No	BDU+T-shirt
70	7	Moderate	0.9 m <sup>2</sup>	Mask	None	Exposed/ Dismounted	Exposed/ Dismounted	No	BDU+T-shirt
71	7	Moderate	0.9 m <sup>2</sup>	Mask	None	Exposed/ Dismounted	Exposed/ Dismounted	No	BDU+T-shirt
72	7	Moderate	0.9 m <sup>2</sup>	Mask	None	Foxhole	Foxhole	No	BDU+T-shirt
73	12	Moderate	0.9 m <sup>2</sup>	Mask	Stationary Vehicle – Closed Windows, Fan on Recirculation	Armored Personnel Carrier	Armored Personnel Carrier – Open	No	BDU+T-shirt
74	12	Moderate	0.9 m <sup>2</sup>	Mask	Stationary Vehicle – Closed Windows, Fan on Recirculation	Armored Personnel Carrier	Armored Personnel Carrier – Open	No	BDU+T-shirt
75	12	Moderate	0.9 m <sup>2</sup>	Mask	Stationary Vehicle – Closed Windows, Fan on Recirculation	Armored Personnel Carrier	Armored Personnel Carrier – Open	No	BDU+T-shirt
76	2	Light	0.9 m <sup>2</sup>	Mask	Stationary Vehicle – Closed Windows, Fan on Recirculation	Armored Personnel Carrier	Armored Personnel Carrier – Open	No	BDU+T-shirt

**ANNEX A TO  
AMedP-7.5**

See Section:		2.1.3	2.1.4	2.1.5	2.1.6	2.1.6	4.4.4	4.4.4	4.4.4
Icon #	# Personnel	Activity Level	Body Surface Area	IPE Class	Vehicle/Shelter Information				
					Ventilation Class	Radiation Class	Thermal class	Icon Warned?	Uniform Type
77	2	Light	0.9 m <sup>2</sup>	Mask	Stationary Vehicle – Closed Windows, Fan on Recirculation	Armored Personnel Carrier	Armored Personnel Carrier – Open	No	BDU+T-shirt
78	2	Light	0.9 m <sup>2</sup>	Mask	Stationary Vehicle – Closed Windows, Fan on Recirculation	Armored Personnel Carrier	Armored Personnel Carrier – Open	No	BDU+T-shirt
79	2	Light	0.9 m <sup>2</sup>	Mask	Stationary Vehicle – Closed Windows, Fan on Recirculation	Armored Personnel Carrier	Armored Personnel Carrier – Open	No	BDU+T-shirt
80	2	Light	0.9 m <sup>2</sup>	Mask	Stationary Vehicle – Closed Windows, Fan on Recirculation	Armored Personnel Carrier	Armored Personnel Carrier – Open	No	BDU+T-shirt
81	2	Light	0.9 m <sup>2</sup>	Mask	Stationary Vehicle – Closed Windows, Fan on Recirculation	Armored Personnel Carrier	Armored Personnel Carrier – Open	No	BDU+T-shirt
82	2	Light	0.9 m <sup>2</sup>	Mask	Stationary Vehicle – Closed Windows, Fan on Recirculation	Armored Personnel Carrier	Armored Personnel Carrier – Open	No	BDU+T-shirt
83	2	Light	0.9 m <sup>2</sup>	Mask	Stationary Vehicle – Closed Windows, Fan on Recirculation	Armored Personnel Carrier	Armored Personnel Carrier – Open	No	BDU+T-shirt
84	4	Heavy	0.9 m <sup>2</sup>	Mask	Stationary Vehicle – Closed Windows, Fan on Recirculation	Armored Personnel Carrier	Armored Personnel Carrier – Open	No	BDU+T-shirt
85	4	Heavy	0.9 m <sup>2</sup>	Mask	Stationary Vehicle – Closed Windows, Fan on Recirculation	Armored Personnel Carrier	Armored Personnel Carrier – Open	No	BDU+T-shirt
86	4	Heavy	0.9 m <sup>2</sup>	Mask	Stationary Vehicle – Closed Windows, Fan on Recirculation	Armored Personnel Carrier	Armored Personnel Carrier – Open	No	BDU+T-shirt

**ANNEX A TO  
AMedP-7.5**

See Section:		2.1.3	2.1.4	2.1.5	2.1.6	2.1.6	4.4.4	4.4.4	4.4.4
Icon #	# Personnel	Activity Level	Body Surface Area	IPE Class	Vehicle/Shelter Information				
					Ventilation Class	Radiation Class	Thermal class	Icon Warned?	Uniform Type
87	4	Heavy	0.9 m <sup>2</sup>	Mask	Stationary Vehicle – Closed Windows, Fan on Recirculation	Armored Personnel Carrier	Armored Personnel Carrier – Open	No	BDU+T-shirt
88	4	Heavy	0.9 m <sup>2</sup>	Mask	Stationary Vehicle – Closed Windows, Fan on Recirculation	Armored Personnel Carrier	Armored Personnel Carrier – Open	No	BDU+T-shirt
89	4	Moderate	0.9 m <sup>2</sup>	None	Vehicle w/ColPro	Armored Personnel Carrier	Armored Personnel Carrier – Open	No	BDU+T-shirt
90	4	Heavy	0.9 m <sup>2</sup>	None	Vehicle w/ColPro	Armored Personnel Carrier	Armored Personnel Carrier – Open	No	BDU+T-shirt
91	4	Moderate	0.9 m <sup>2</sup>	None	Vehicle w/ColPro	Armored Personnel Carrier	Armored Personnel Carrier – Open	No	BDU+T-shirt
92	2	Moderate	0.9 m <sup>2</sup>	None	Shelter w/ColPro	Tent	Tent	No	BDU+T-shirt
93	4	Moderate	0.9 m <sup>2</sup>	None	Vehicle w/ColPro	Armored Personnel Carrier	Armored Personnel Carrier – Open	No	BDU+T-shirt
94	10	Moderate	0.9 m <sup>2</sup>	Mask	Stationary Vehicle – Closed Windows, Fan on Recirculation	Armored Personnel Carrier	Armored Personnel Carrier – Open	No	BDU+T-shirt
95	2	Moderate	0.9 m <sup>2</sup>	None	Shelter w/ColPro	Tent	Tent	No	BDU+T-shirt
96	10	Moderate	0.9 m <sup>2</sup>	Mask	Stationary Vehicle – Closed Windows, Fan on Recirculation	Armored Personnel Carrier	Armored Personnel Carrier – Open	No	BDU+T-shirt
97	2	Moderate	0.9 m <sup>2</sup>	None	Shelter w/ColPro	Tent	Tent	No	BDU+T-shirt
98	10	Moderate	0.9 m <sup>2</sup>	Mask	Stationary Vehicle – Closed Windows, Fan on Recirculation	Armored Personnel Carrier	Armored Personnel Carrier – Open	No	BDU+T-shirt

**ANNEX A TO  
AMedP-7.5**

See Section:		2.1.3	2.1.4	2.1.5	2.1.6	2.1.6	4.4.4	4.4.4	4.4.4
Icon #	# Personnel	Activity Level	Body Surface Area	IPE Class	Vehicle/Shelter Information				
					Ventilation Class	Radiation Class	Thermal class	Icon Warned?	Uniform Type
99	10	Moderate	0.9 m <sup>2</sup>	Mask	Stationary Vehicle – Closed Windows, Fan on Recirculation	Armored Personnel Carrier	Armored Personnel Carrier – Open	No	BDU+T-shirt
100	10	Moderate	0.9 m <sup>2</sup>	Mask	Stationary Vehicle – Closed Windows, Fan on Recirculation	Armored Personnel Carrier	Armored Personnel Carrier – Open	No	BDU+T-shirt
101	10	Moderate	0.9 m <sup>2</sup>	Mask	Stationary Vehicle – Closed Windows, Fan on Recirculation	Armored Personnel Carrier	Armored Personnel Carrier – Open	No	BDU+T-shirt
102	10	Heavy	0.9 m <sup>2</sup>	Mask	Stationary Vehicle – Open Windows, No Ventilation	Tent	Tent	No	BDU+T-shirt
103	10	Moderate	0.9 m <sup>2</sup>	Mask	Stationary Vehicle – Closed Windows, Fan on Recirculation	Van	Semi-Trailer Van	No	BDU+T-shirt
104	4	Moderate	0.9 m <sup>2</sup>	Mask	Stationary Vehicle – Open Windows, No Ventilation	Van	Panel Van	No	BDU+T-shirt
105	10	Moderate	0.9 m <sup>2</sup>	Mask	Stationary Vehicle – Closed Windows, Fan on Recirculation	Van	Semi-Trailer Van	No	BDU+T-shirt
106	4	Moderate	0.9 m <sup>2</sup>	Mask	None	Exposed/ Dismounted	Exposed/ Dismounted	No	BDU+T-shirt
107	10	Moderate	0.9 m <sup>2</sup>	Mask	Stationary Vehicle – Closed Windows, Fan on Recirculation	Armored Personnel Carrier	Armored Personnel Carrier – Open	No	BDU+T-shirt
108	1	Moderate	0.9 m <sup>2</sup>	Mask	Stationary Vehicle – Open Windows, No Ventilation	Tent	Tent	No	BDU+T-shirt
109	10	Moderate	0.9 m <sup>2</sup>	Mask	Stationary Vehicle – Closed Windows, Fan on Recirculation	Van	Semi-Trailer Van	No	BDU+T-shirt
110	1	Moderate	0.9 m <sup>2</sup>	Mask	None	Exposed/ Dismounted	Exposed/ Dismounted	No	BDU+T-shirt
111	10	Moderate	0.9 m <sup>2</sup>	Mask	Stationary Vehicle – Closed Windows, Fan on Recirculation	Van	Semi-Trailer Van	No	BDU+T-shirt
112	3	Moderate	0.9 m <sup>2</sup>	Mask	None	Foxhole	Foxhole	No	BDU+T-shirt

**ANNEX A TO  
AMedP-7.5**

See Section:		2.1.3	2.1.4	2.1.5	2.1.6	2.1.6	4.4.4	4.4.4	4.4.4
Icon #	# Personnel	Activity Level	Body Surface Area	IPE Class	Vehicle/Shelter Information				
					Ventilation Class	Radiation Class	Thermal class	Icon Warned?	Uniform Type
113	4	Moderate	0.9 m <sup>2</sup>	Mask	Stationary Vehicle – Open Windows, No Ventilation	Tent	Tent	No	BDU+T-shirt
114	4	Moderate	0.9 m <sup>2</sup>	Mask	Stationary Vehicle – Open Windows, No Ventilation	Tent	Tent	No	BDU+T-shirt
115	10	Moderate	0.9 m <sup>2</sup>	None	Vehicle w/ColPro	Tank	Tank – Movement	No	BDU+T-shirt
116	10	Moderate	0.9 m <sup>2</sup>	None	Vehicle w/ColPro	Tank	Tank – Movement	No	BDU+T-shirt
117	1	Heavy	0.9 m <sup>2</sup>	Mask	Residential Building – Open Windows	Wood Frame Building	Wood Frame Building	No	BDU+T-shirt
118	1	Heavy	0.9 m <sup>2</sup>	Mask	Residential Building – Open Windows	Wood Frame Building	Wood Frame Building	No	BDU+T-shirt
119	1	Heavy	0.9 m <sup>2</sup>	Mask	Residential Building – Open Windows	Wood Frame Building	Wood Frame Building	No	BDU+T-shirt
120	1	Moderate	0.9 m <sup>2</sup>	Mask	None	Foxhole	Foxhole	No	BDU+T-shirt
121	1	Moderate	0.9 m <sup>2</sup>	Mask	None	Foxhole	Foxhole	No	BDU+T-shirt
122	1	Moderate	0.9 m <sup>2</sup>	Mask	None	Exposed/ Dismounted	Exposed/ Dismounted	No	BDU+T-shirt
123	1	Heavy	0.9 m <sup>2</sup>	Mask	Residential Building – Open Windows	Wood Frame Building	Wood Frame Building	No	BDU+T-shirt
124	1	At Rest	0.9 m <sup>2</sup>	Mask	Residential Building – Open Windows	Wood Frame Building	Wood Frame Building	No	BDU+T-shirt
125	1	Moderate	0.9 m <sup>2</sup>	None	Shelter w/ColPro	Multi-Story Brick Building	Multi-Story Brick Building	No	BDU+T-shirt
126	3	Heavy	0.9 m <sup>2</sup>	Mask	Stationary Vehicle – Open Windows, No Ventilation	Van	Panel Van	No	BDU+T-shirt
127	4	Heavy	0.9 m <sup>2</sup>	Mask	Stationary Vehicle – Open Windows, No Ventilation	Van	Panel Van	No	BDU+T-shirt
128	4	Moderate	0.9 m <sup>2</sup>	None	Shelter w/ColPro	Tent	Tent	No	BDU+T-shirt
129	4	Moderate	0.9 m <sup>2</sup>	Mask	Stationary Vehicle – Open Windows, No Ventilation	Van	Panel Van	No	BDU+T-shirt
130	4	Moderate	0.9 m <sup>2</sup>	Mask	Stationary Vehicle – Open Windows, No Ventilation	Tent	Tent	No	BDU+T-shirt

**ANNEX A TO  
AMedP-7.5**

See Section:		2.1.3	2.1.4	2.1.5	2.1.6	2.1.6	4.4.4	4.4.4	4.4.4
Icon #	# Personnel	Activity Level	Body Surface Area	IPE Class	Vehicle/Shelter Information				
					Ventilation Class	Radiation Class	Thermal class	Icon Warned?	Uniform Type
131	2	Moderate	0.9 m <sup>2</sup>	None	Shelter w/ColPro	Masonry Building	Masonry Building – Many Windows	No	BDU+T-shirt
132	1	Moderate	0.9 m <sup>2</sup>	None	Shelter w/ColPro	Masonry Building	Masonry Building – Many Windows	No	BDU+T-shirt
133	1	Moderate	0.9 m <sup>2</sup>	None	Shelter w/ColPro	Masonry Building	Masonry Building – Many Windows	No	BDU+T-shirt
134	1	At Rest	0.9 m <sup>2</sup>	Mask	Residential Building – Open Windows	Wood Frame Building	Wood Frame Building	No	BDU+T-shirt
135	2	Moderate	0.9 m <sup>2</sup>	None	Shelter w/ColPro	Tent	Tent	No	BDU+T-shirt
136	5	Moderate	0.9 m <sup>2</sup>	Mask	None	Foxhole	Foxhole	No	BDU+T-shirt
137	1	Moderate	0.9 m <sup>2</sup>	Mask	Stationary Vehicle – Open Windows, No Ventilation	Tent	Tent	No	BDU+T-shirt
138	1	Moderate	0.9 m <sup>2</sup>	Mask	Stationary Vehicle – Open Windows, No Ventilation	Tent	Tent	No	BDU+T-shirt
139	3	Moderate	0.9 m <sup>2</sup>	Mask	None	Foxhole	Foxhole	No	BDU+T-shirt
140	4	Moderate	0.9 m <sup>2</sup>	Mask	None	Exposed/Dismounted	Exposed/Dismounted	No	BDU+T-shirt
141	1	Heavy	0.9 m <sup>2</sup>	Mask	Residential Building – Open Windows	Wood Frame Building	Wood Frame Building	No	BDU+T-shirt
142	1	Heavy	0.9 m <sup>2</sup>	Mask	Residential Building – Open Windows	Wood Frame Building	Wood Frame Building	No	BDU+T-shirt
143	1	Heavy	0.9 m <sup>2</sup>	Mask	Residential Building – Open Windows	Wood Frame Building	Wood Frame Building	No	BDU+T-shirt
144	1	Moderate	0.9 m <sup>2</sup>	Mask	Stationary Vehicle – Open Windows, No Ventilation	Van	Panel Van	No	BDU+T-shirt
145	1	At Rest	0.9 m <sup>2</sup>	Mask	Residential Building – Open Windows	Wood Frame Building	Wood Frame Building	No	BDU+T-shirt
146	1	At Rest	0.9 m <sup>2</sup>	Mask	Residential Building – Open Windows	Wood Frame Building	Wood Frame Building	No	BDU+T-shirt
147	1	Moderate	0.9 m <sup>2</sup>	None	Shelter w/ColPro	Multi-Story Brick Building	Multi-Story Brick Building	No	BDU+T-shirt

**ANNEX A TO  
AMedP-7.5**

See Section:		2.1.3	2.1.4	2.1.5	2.1.6	2.1.6	4.4.4	4.4.4	4.4.4
Icon #	# Personnel	Activity Level	Body Surface Area	IPE Class	Vehicle/Shelter Information				
					Ventilation Class	Radiation Class	Thermal class	Icon Warned?	Uniform Type
148	3	Heavy	0.9 m <sup>2</sup>	Mask	Stationary Vehicle – Open Windows, No Ventilation	Van	Panel Van	No	BDU+T-shirt
149	3	Moderate	0.9 m <sup>2</sup>	Mask	None	Foxhole	Foxhole	No	BDU+T-shirt
150	1	Moderate	0.9 m <sup>2</sup>	Mask	Stationary Vehicle – Open Windows, No Ventilation	Tent	Tent	No	BDU+T-shirt
151	6	Moderate	0.9 m <sup>2</sup>	None	Shelter w/ColPro	Tent	Tent	No	BDU+T-shirt
152	1	Moderate	0.9 m <sup>2</sup>	Mask	Stationary Vehicle – Open Windows, No Ventilation	Van	Panel Van	No	BDU+T-shirt
153	6	Moderate	0.9 m <sup>2</sup>	None	Shelter w/ColPro	Tent	Tent	No	BDU+T-shirt
154	1	Moderate	0.9 m <sup>2</sup>	None	Shelter w/ColPro	Masonry Building	Masonry Building – Many Windows	No	BDU+T-shirt
155	1	Moderate	0.9 m <sup>2</sup>	None	Shelter w/ColPro	Masonry Building	Masonry Building – Many Windows	No	BDU+T-shirt



### A.2.2. Methodology Parameters

The values of the methodology parameters for the different scenarios have been chosen with the goal of illustrating different features of the methodology, but also minimizing the length of Annex A. Thus, in most cases, the default parameter values from Table 2-14 are used.

**Table A-2: Values of Methodology Parameters for Illustrative Examples**

Parameter	GB	CK	<sup>137</sup> Cs RDD	Nuclear: 10 kT Ground	Anthrax	Smallpox
T <sub>MTF</sub>	30 minutes	30 minutes	30 minutes	30 minutes	30 minutes	30 minutes
T <sub>death-CN-SL4</sub>	15 minutes	15 minutes	15 minutes	15 minutes	N/A	N/A
Flag <sub>MT</sub>	No* Yes, MT <sub>GB</sub> =FMT*	Yes MT <sub>CK</sub> = AT	Yes No G-CSF	Yes No G-CSF	Yes	Yes
Casualty Criterion	WIA(1+)	WIA(2+)	WIA(1+)	WIA(1+)	WIA(1+)	WIA(1+)* WIA(3+)*
d <sub>trt-Q</sub> or d <sub>vac-spox</sub>	N/A	N/A	N/A	N/A	7	12



\* Separate examples for both options will be illustrated.

### A.3. CHEMICAL AGENT: GB

1. The following excerpt from Table 1-5 shows which sections of AMedP-7.5 explain how to complete the five major steps for a GB casualty estimate.

Agent, Effect, or Disease	Five Steps			
	INPUT	CHALLENGE	RESPONSE/STATUS	REPORT
GB	Ch. 2	Ch. 3	Sections 4.2.3 and 4.1	Ch. 6

2. In order to more easily follow along with the example, it is recommended that the reader print and have available for reference the following figures and tables: Figure 1-1, Figure 1-3, the annotated version of Figure 4-4 located on the next page, Table 4-4 to Table 4-6, and Table A-1.

3. The red octagons containing a single letter in the annotated version of Figure 4-4 are user aids to help link the text later in the GB example to the various parts of the flowchart. Specifically, the red octagons are used to mark the *beginning* of the text discussion related to the linked flowchart element. For example, the  on the first line of Section A.3.2 indicates that the discussion of the calculation of the Effective CBRN Challenge ( $X_{GB,ih,n}^{eff}$ ) begins there;  is linked to the calculation of  $X_{GB,ih,n}^{eff}$  because of its placement in the annotated version of Figure 4-4.

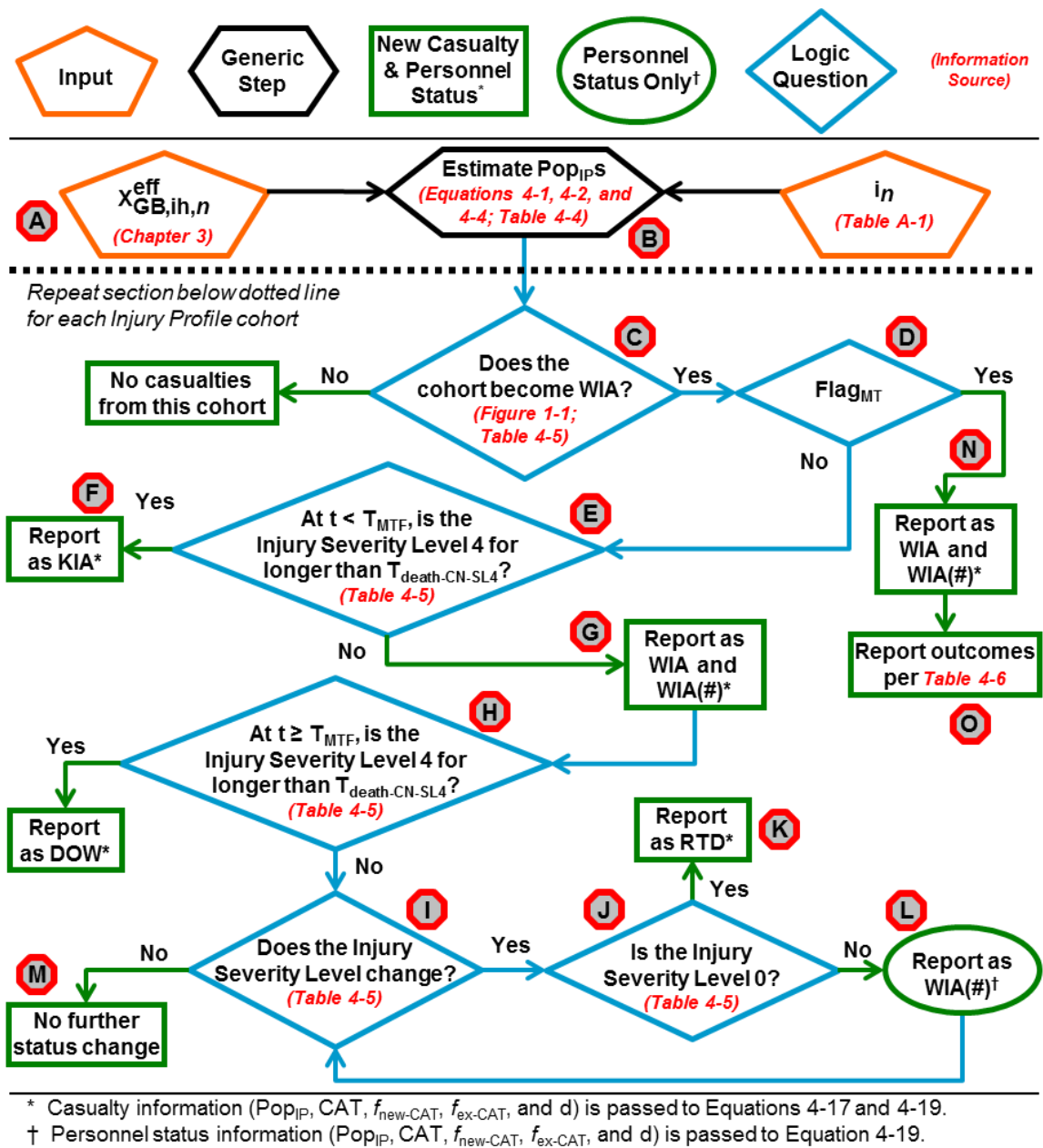

Figure 4-4 Annotated for Illustrative Example

4. As noted in Table A-2, the GB example will illustrate the process for a casualty criterion of WIA(1+) and both possible values of  $Flag_{MT}$ . The INPUT and CHALLENGE portions of the example are the same regardless of the value of  $Flag_{MT}$ , as is a portion of the RESPONSE/STATUS section. The remainder of the RESPONSE/STATUS section and the REPORT section are different for different values of  $Flag_{MT}$ .

### A.3.1. INPUT

1. The only INPUT needed that was not given in Section A.2 is the CBRN Challenge per icon over time. This step is not associated with a red octagon because

it occurs in the flowchart of Figure 1-3, which is “upstream” of Figure 4-4. Finally, as stated in Section 2.1.2, the CBRN Challenge must be generated independently of AMedP-7.5, using national tools.

2. The simulated attack comprised 240 122 mm chemical rockets, each containing 2.4 kg of GB, for a total attack payload of 576 kg GB. The aim point was approximately at the center of mass of the icons on the airfield, and all 240 rockets detonated within 125 meters of the target. The simulated attack occurred at 2000 hours on cultivated terrain. Meteorological conditions were no cloud cover, wind at an average speed of about 2 m/s from the southwest toward the northeast, and an average temperature of 20.7 °C. Figure A-2 is a qualitative depiction of the CBRN Challenge (cumulative) at the end of the simulation. Each filled red circle represents an icon in the task force, and the GB plume is depicted with colors indicating different amounts of CBRN Challenge (purple is low, red is high).

3. To generate the quantitative input needed for AMedP-7.5, the CBRN Challenge per icon was extracted from HPAC in one-minute intervals. The extracted data for 8 selected icons are shown in Table A-3. Only the first 7 minutes are shown because after that time, no changes in CBRN Challenge occur for the 8 icons.

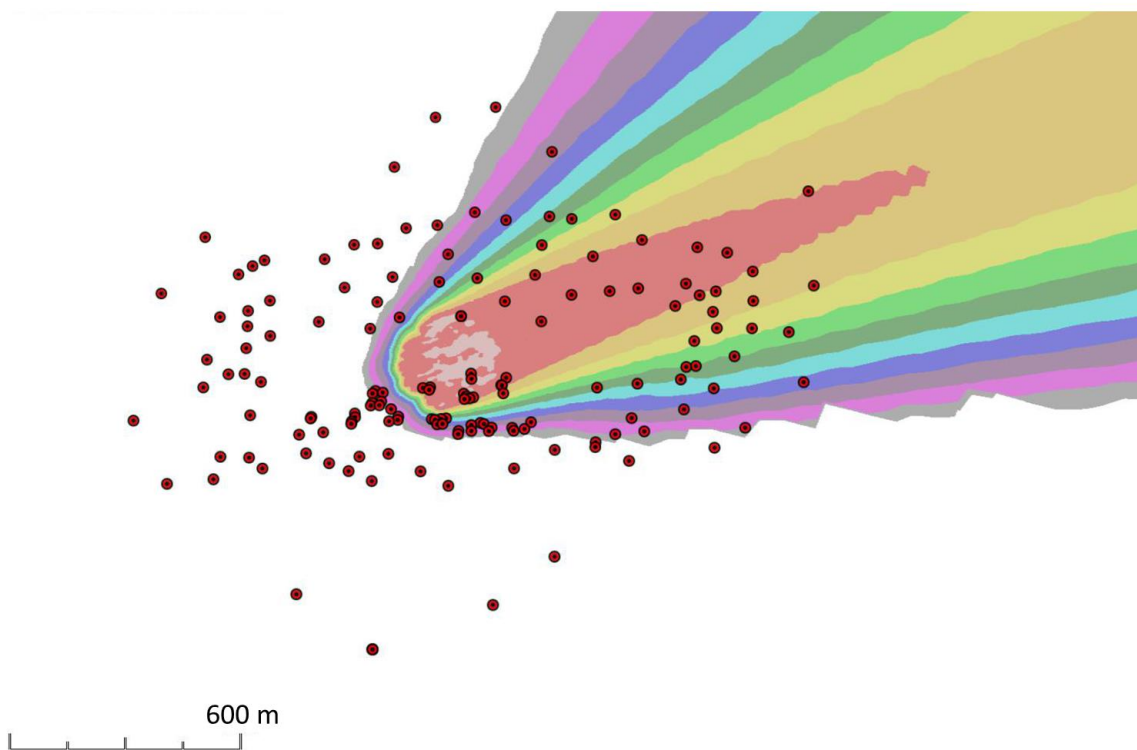

**Figure A-2: GB Attack on Task Force**

**Table A-3: GB CBRN Challenge Data for Selected Icons**

Icon # (n)	$X_{GB,ih,n,t_k}$ [mg-min/m <sup>3</sup> ] at Time $t_k$ [min]						
	1	2	3	4	5	6	7
3	370.833	510.300	510.583	510.583	510.583	510.583	510.583
4	0	0.004	1.397	3.854	4.118	4.126	4.127
22	0	0.241	1.319	1.564	1.575	1.576	1.576
54	0	0.120	2.157	3.088	3.158	3.162	3.162
58	0	0.001	1.828	8.065	9.097	9.141	9.142
99	173.250	502.333	510.583	510.633	510.633	510.633	510.633
124	146.555	146.642	146.642	146.642	146.642	146.642	146.642
133	954.583	956.867	956.883	956.883	956.883	956.883	956.883

### A.3.2. CHALLENGE



1. As indicated in Figure 4-4, the calculation of  $X_{GB,ih,n}^{eff}$  is done per Chapter 3.
2. Because the icon attributes do not change over time, the sum in Equation 3-1 needs only a single term; the sum does not need to be expanded into a term for each minute of challenge data. Thus, Equation 3-1 for any icon can be simplified to:

$$X_{GB,ih,n}^{eff} = \frac{(X_{GB,ih,n,7} - 0) \cdot Z_n}{APF_{GB,ih,n}} \quad (3-1)$$

3. The value of  $X_{GB,ih,n,7}$  is in the Minute 7 column of Table A-3.
4. The value of  $Z_n$  is determined by matching the specified Activity Level in Table A-1 with the corresponding unitless factor from Table 2-3. For example, Table A-1 specifies Moderate activity for icon 3, and Table 2-3 says that Moderate activity corresponds to a unitless factor of 2, so  $Z_3 = 2$ .
5. The value of the aggregate protection factor ( $APF_{GB,ih,n}$ ) is calculated according to Sections 2.1.5, 2.1.6, 2.1.7, and 2.1.9. The details depend on the vehicle or shelter the icon occupies.
  - a. The protection factors for IPE and prophylaxis are straightforward to determine. The scenario does not include prophylaxis, so  $PF_{proph,GB,ih,n}$  is 1 for all icons. The protection factor from IPE is determined by matching the specified IPE Class in Table A-1 with a PF in Table 2-4. For example, Table A-1 specifies that icon 99 is wearing masks, and Table 2-4 says that a mask gives an inhalation protection factor of 100,000, so  $PF_{IPE,ih,99} = 100,000$ .
  - b. Vehicle or shelter protection factor ( $PF_{V-SH,ih,n}$ ).
    - 1) If the icon's vehicle or shelter ventilation class is "None,"  $PF_{V-SH,ih,n} = 1$ , per Table 2-6.

- 2) If the icon's vehicle or shelter ventilation class is "Vehicle w/ColPro," or "Shelter w/ColPro,"  $PF_{V-SH,ih,n} = 3000$ , per Table 2-6.
- 3) If the icon is in a vehicle or shelter that does not have ColPro, Equation 2-1 must be used to calculate  $PF_{V-SH,ih,n}$ . As an example, take icon 99: the vehicle is "Stationary Vehicle – Closed Windows, Fan on Recirculation." According to Table 2-5,  $AER_{99}$  is 20. Table A-3 shows that the CBRN Challenge increases between the end of minute 1 and the end of minute 4, so  $Duration_{99}$  is 3 minutes or 0.05 hr. Since the input data specified that icons remain in their shelter or vehicle,  $Occupancy_{99}$  is until the end of the scenario, which is ill-defined. Arbitrarily assigning the value to 12 minutes, or 0.2 hr, the calculation of  $PF_{V-SH,ih,n}$  is below. Note that as  $Occupancy$  increases beyond  $Duration$ , the  $PF_{V-SH,ih,n}$  decreases.

$$PF_{V-SH,ih,pv,n} = \frac{20 \cdot 0.05}{20 \cdot 0.05 + e^{(-20 \cdot 0.2)} - e^{20 \cdot (0.05 - 0.2)}} = 1.03 \quad (2-1)$$

c. Finally, according to Equation 2-2, the APF for icon 99, for example, is:

$$APF_{GB,ih,99} = PF_{IPE,GB,ih,99} \cdot PF_{V-SH,GB,ih,99} \cdot PF_{proph,GB,ih,99} \\ = 100,000 \cdot 1.03 \cdot 1 = 103,000$$

6. Following the pattern of paragraphs 2 through 4, the entries in Table A-4 can be populated. Then,  $X_{GB,ih,n}^{eff}$  is calculated by the simplified form of Equation 3-1 given at the end of paragraph A.3.2.2.

- a. Because the IPE, vehicles, and shelters listed in Table A-1 protect so effectively, the calculated  $X_{GB,ih,n}^{eff}$  for each icon in Table A-4 (and the entire scenario) are so low that very few casualties will occur.
- b. Thus, for the purpose of illustrating the methodology, the calculation of  $X_{GB,ih,n}^{eff}$  is repeated with  $APF_{GB,ih,n}$  set to 1—the results are labeled "Unprotected  $X_{GB,ih,n}^{eff}$ " in Table A-4.

**Table A-4: Calculation of GB Effective CBRN Challenge for Selected Icons**

Icon # (n)	$X_{GB,ih,n,7}$ [mg-min/m <sup>3</sup> ]	$Z_n$ [unitless]	$APF_{GB,ih,n}$ [unitless]	$X_{GB,ih,n}^{eff}$ [mg-min/m <sup>3</sup> ]	Unprotected $X_{GB,ih,n}^{eff}$ [mg-min/m <sup>3</sup> ]
3	510.583	0.5	150,000	0.0017	255.29
4	4.127	2	3,000	0.0028	8.25
22	1.576	2	100,000	0.0000	3.15
54	3.162	2	100,000	0.0001	6.32
58	9.142	2	100,000	0.0002	18.28
99	510.633	2	103,000	0.0099	1021.27
124	146.642	0.5	146,000	0.0005	73.32
133	956.883	2	3000	0.6379	1914

7. The “Unprotected  $X_{GB,ih,n}^{eff}$ ” values will be used for the rest of the GB example to illustrate the RESPONSE, STATUS, and REPORT portions of the methodology.

### A.3.3. RESPONSE/STATUS



1. According to Figure 4-4, with  $X_{GB,ih,n}^{eff}$  and  $i_n$  available for all icons, the next step is to calculate the population of the Injury Profile cohorts (Pop<sub>IPS</sub>), using Equations 4-1, 4-2, and 4-4, and Table 4-4.

a. Taking icon 58 as an example,  $X_{GB,ih,58}^{eff}$  is 18.28 mg-min/m<sup>3</sup>. Applying Equation 4-1 for all four levels of effect (values of  $k$ ) makes use of the toxicity parameters given in Table 4-4:

$$p_{GB,ih\_mild,58} = \Phi \left( PS_{GB,ih\_mild} \cdot \log_{10} \left( \frac{X_{GB,ih,58}^{eff}}{ECt_{50,GB,ih\_mild}} \right) \right) = \Phi \left( 4.5 \cdot \log_{10} \left( \frac{18.28}{0.4} \right) \right) = 1.0$$

$$p_{GB,ih\_moderate,58} = \Phi \left( 12 \cdot \log_{10} \left( \frac{18.28}{1.2} \right) \right) = 1.0$$

$$p_{GB,ih\_severe,58} = \Phi \left( 12 \cdot \log_{10} \left( \frac{18.28}{25} \right) \right) = 0.0514$$

$$p_{GB,ih\_very\ severe,58} = \Phi \left( 12 \cdot \log_{10} \left( \frac{18.28}{33} \right) \right) = 0.0010$$

b. Recall that the values calculated above must now be used to determine which fraction of personnel has each value of  $k$  as their *worst* level of effect (to avoid double-counting). According to Equation 4-2:

$$p_{w,GB,ih\_mild,58} = p_{GB,ih\_mild,58} - p_{GB,ih\_moderate,58} = 0$$

$$p_{w,GB,ih\_moderate,58} = p_{GB,ih\_moderate,58} - p_{GB,ih\_severe,58} = 0.9486$$

$$p_{w,GB,ih\_severe,58} = p_{GB,ih\_severe,58} - p_{GB,ih\_very\ severe,58} = 0.0504$$

$$p_{w,GB,ih\_very\ severe,58} = p_{GB,ih\_very\ severe,58} - 0 = 0.0010$$

c. One may note that the methodology will estimate that, for example, 0.3528 individuals from cohort 58 enter the Severe Injury Profile cohort. Although this may seem odd when considered at an individual level, the models are intended for application at the population level—that is, rounding to whole numbers of individuals will be done at the end of the process.

d. Using Equation 4-4 requires input related to all icons in the scenario, and the equation is rather straightforward, so it will not be demonstrated here. The

results of using Equations 4-1 and 4-2 for all 155 icons, and then using Equation 4-4, are given in Table A-5.

**Table A-5: Injury Profile Cohort Populations for GB Illustrative Example**

Injury Profile	Cohort Population (from Equation 4-4)
Mild	17.73
Moderate	39.26
Severe	0.64
Very Severe	183.72

**C**

2. According to Figure 4-4, the next step is to answer the question “Does the cohort become WIA?” using Figure 1-1 and the Injury Profiles (Table 4-5).

a. The casualty criterion is WIA(1+), per Table A-2; all cohorts become WIA.

3. The text at the bottom of Figure 4-4 states that certain information is passed to Equations 4-17 and 4-19. Paragraphs 4 and 5 (and sub-parts), below, will first summarize in plain text the information passed to the equations. Then, following the convention listed at the bottom of Figure 4-4, the information passed to the equations will be listed in this format: [**Pop<sub>IP</sub>, CAT, f<sub>new-CAT</sub>, f<sub>ex-CAT</sub>, d**].

**D**

4. Still following Figure 4-4, the next several steps depend upon the value of Flag<sub>MT</sub>. First, consider the case in which Flag<sub>MT</sub> = No.

**E**

a. “At  $t < T_{MTF}$ , is the Injury Severity Level 4 for longer than  $T_{death-CN-SL4}$ ?”

**F**

1) For the Very Severe cohort, yes. The Very Severe cohort is reported as KIA on Day 1.

**[183.72, KIA, 1.0, 0, 1]**

**G**

2) For the Mild, Moderate, and Severe cohorts, no, so the flowchart indicates “Report as WIA and WIA(#).” All three cohorts are reported as WIA on Day 1. The Mild, Moderate, and Severe cohorts are also reported as WIA(1), WIA(2), and WIA(3), respectively, on Day 1.

**[17.73, WIA or WIA(1), 1.0, 0, 1] ; [39.26, WIA or WIA(2), 1.0, 0, 1] ; [0.64, WIA or WIA(3), 1.0, 0, 1]**

**H**

b. “At  $t < T_{MTF}$ , is the Injury Severity Level 4 for longer than  $T_{death-CN-SL4}$ ?”

1) No, for all three remaining cohorts.

I J

c. "Does the Injury Severity Level change?" and "Is the Injury Severity Level 0?"

K

1) The Mild cohort changes to Injury Severity Level 0 on Day 1. The Mild cohort has already been reported as WIA and WIA(1) on Day 1, so it now must be reported as RTD on Day 2.

**[17.73, WIA(1), 0, 1.0, 2] ; [17.73, RTD, 1.0, 0, 2]**

L M

2) The Moderate cohort changes to Injury Severity Level 1 at 1920 minutes (32 hours); the Moderate cohort shall be reported as WIA(1) on Day 2, and will then have no further status change.

**[39.26, WIA(2), 0, 1.0, 2] ; [39.26, WIA(1), 1.0, 0, 2]**

L L M

3) The Severe cohort changes to Injury Severity Level 2 at 1920 minutes (32 hours) and to Injury Severity Level 1 at 8640 minutes (144 hours); the Severe cohort shall be reported as WIA(2) on Day 2, then as WIA(1) on Day 7, and will then have no further status change.

**[0.64, WIA(3), 0, 1.0, 2] ; [0.64, WIA(2), 1.0, 0, 2] ;  
[0.64, WIA(2), 0, 1.0, 7] ; [0.64, WIA(1), 1.0, 0, 7]**

N

5. Now consider the case in which  $Flag_{MT} = \text{Yes}$  and  $MT_{GB} = \text{FMT}$ , that is, following a different path through Figure 4-4.

a. "Report as WIA and WIA(#)."

1) All four cohorts are reported as WIA on Day 1. The Mild, Moderate, Severe, and Very Severe cohorts are also reported as WIA(1), WIA(2), WIA(3), and WIA(4), respectively, on Day 1.

**[17.73, WIA or WIA(1), 1.0, 0, 1] ; [39.26, WIA or WIA(2), 1.0, 0, 1] ;  
[0.64, WIA or WIA(3), 1, 0, 1]; [183.72, WIA or WIA(4), 1.0, 0, 1]**

O

b. "Report outcomes per Table 4-6."

1) Per Table 4-6, the Mild cohort will be CONV on Day 2 and RTD on Day 8.

**[17.73, WIA(1), 0, 1.0, 2] ; [17.73, CONV, 1.0, 0, 2] ;  
[17.73, CONV, 0, 1.0, 8] ; [17.73, RTD, 1.0, 0, 8]**

2) Per Section 4.1.1.6, the Moderate cohort will remain as WIA(2) for Day 2.



Per Table 4-6, the Moderate cohort will be CONV on Day 3 and RTD on Day 15.

**[39.26, WIA(2), 0, 1.0, 3] ; [39.26, CONV, 1.0, 0, 3] ;  
[39.26, CONV, 0, 1.0, 15] ; [39.26, RTD, 1.0, 0, 15]**

- 3) Per Section 4.1.1.6, the Severe cohort will remain as WIA(3) for Days 2 through 3. Then, per Table 4-6, 50% of the Severe cohort will become CONV on each of Days 4 and 5, and on Day 31, 100% of the Severe cohort will become RTD.

**[0.64, WIA(3), 0, 0.5, 4] ; [0.64, CONV, 0.5, 0, 4]  
[0.64, WIA(3), 0, 0.5, 5] ; [0.64, CONV, 0.5, 0, 5]  
[0.64, CONV, 0, 1.0, 31] ; [0.64, RTD, 1.0, 0, 31]**

- 4) Per Section 4.1.1.6, survivors Very Severe cohort will become WIA(3) on Day 2, while any who will not survive will remain WIA(4) until they DOW. As  $MT_{GB} = FMT$ , the threshold  $X_{GB,ih,n}^{eff}$  that would cause an individual to die despite medical treatment is  $165 \text{ mg-min/m}^3$ . Of the 183.72 in the Very Severe cohort, 161 had  $X_{GB,ih,n}^{eff}$  above the threshold, so they will be DOW on Day 2. The remainder, 22.72, will be WIA(3) beginning Day 2, and CONV on Day 15.

**[183.72, WIA(4), 0, 1.0, 2] ;  
[22.72, WIA(3), 1.0, 0, 2] ; [161, DOW, 1.0, 0, 2]  
[22.72, WIA(3), 0, 1.0, 15] ; [22.72, CONV, 1.0, 0, 15]**

### **A.3.4. REPORT**

1. Section A.3.3 stated the information that would be reported to Equations 4-17 and 4-19. This section will show how that information is used to populate the output tables.

2. As an example of the use of Equation 4-17, consider the application to determine the number of new WIA on Day 1 for the case in which  $Flag_{MT} = \text{No}$ , using the reporting information from Section A.3.3.4. All reporting information for category WIA and day 1 must be considered; the relevant reporting information is:

**[17.73, WIA or WIA(1), 1.0, 0, 1] ; [39.26, WIA or WIA(2), 1.0, 0, 1] ;  
[0.64, WIA or WIA(3), 1.0, 0, 1].**

$$New_{WIA}(1) = 17.73 \cdot 1.0 + 39.26 \cdot 1.0 + 0.64 \cdot 1.0 = 57.63 \approx 58 \quad (4-17)$$

The rate table (Table A-6) reports 58 casualties as new WIA on Day 1.

3. As an example of the use of Equation 4-19, consider the application to determine the total number of WIA(1) on Day 2 for the case in which  $Flag_{MT} = \text{No}$ , using the reporting information from Section A.3.3.4. Equation 4-19 requires that the value for the previous day be known:  $Tot_{WIA(1)}(1) = 17.73$ . Then, all reporting information for category WIA(1) and day 2 must be considered; the relevant reporting information is:

[17.73, WIA(1), 0, 1.0, 2] ; [39.26, WIA(1), 1.0, 0, 2]

$$\text{Tot}_{\text{WIA}(1)}(2) = 17.73 + (17.73 \cdot (0 - 1.0) + 39.26 \cdot (1.0 - 0)) = 39.26 \approx 39 \quad (4-19)$$

The personnel status table (Table A-7) reports 39 casualties as WIA(1) on Day 2.

4. To complete all entries in the reporting tables, Equations 4-17 and 4-19 must be applied for all casualty categories and all days until no further changes occur. As the logic involved in applying the equations has been demonstrated, and for brevity, the remainder of the calculations are not shown here.

5. Table A-6 and Table A-7 are the output tables for the case in which Flag<sub>MT</sub> = No. Note that the estimates stop at Day 7 because no further changes in casualty status occur after Day 7.

**Table A-6: Estimated Daily Number of New GB Casualties\***

Casualty Description	Day 1	Day 2	Day 3	Day 4	Day 5	Day 6	Day 7
New KIA (C)	184	0	0	0	0	0	0
New DOW (CRN)	0	0	0	0	0	0	0
Sum of New Fatalities	184	0	0	0	0	0	0
New WIA (GB)	58	0	0	0	0	0	0
New RTD	0	18	0	0	0	0	0

\* Estimate is based on Casualty Criterion WIA(1+), a PAR of 816, and Flag<sub>MT</sub> = No.

**Table A-7: Estimated Personnel Status for GB Casualties\***

Casualty Description	Day 1	Day 2	Day 3	Day 4	Day 5	Day 6	Day 7
Fatalities							
KIA (C)	184	184	184	184	184	184	184
DOW (CRN)	0	0	0	0	0	0	0
Sum of Fatalities	184	184	184	184	184	184	184
WIA							
GB(1)	18	39	39	39	39	39	40
GB(2)	39	1	1	1	1	1	0
GB(3)	1	0	0	0	0	0	0
Sum of WIA	58	40	40	40	40	40	40
RTD							
RTD	0	18	18	18	18	18	18

\* Estimate is based on Casualty Criterion WIA(1+), a PAR of 816, and Flag<sub>MT</sub> = No.

6. Table A-8 and Table A-9 are the output tables for the case in which Flag<sub>MT</sub> = Yes. Note that the estimates stop at Day 31 because no further changes in casualty status occur after Day 31. Also note that due to the peculiarities of rounding, the total number of individuals accounted for in Table A-9 varies between 242 and 241, depending upon the day. The planner may use either estimate as the difference is only one casualty.

**Table A-8: Estimated Daily Number of New GB Casualties\***

Casualty Description	Day 1	Day 2	Day 3	Days 4-7	Day 8	Day 9-14	Day 15	Day 16-30	Day 31	Day 32+
KIA (C)	0	0	0	0	0	0	0	0	0	0
DOW (CRN)	0	161	0	0	0	0	0	0	0	0
Sum of New Fatalities	0	161	0	0	0	0	0	0	0	0
New WIA (GB)	241	0	0	0	0	0	0	0	0	0
New CONV (GB)	0	18	39	0	0	0	23	0	0	0
New RTD	0	0	0	0	18	0	39	0	1	0

\* Estimate is based on Casualty Criterion WIA(1+), a PAR of 816, Flag<sub>MT</sub> = Yes, and MT<sub>GB</sub> = FMT.

**Table A-9: Estimated Personnel Status for GB Casualties\***

Casualty Description	Day 1	Day 2	Day 3	Day 4	Days 5-7	Days 8-14	Days 15-30	Days 31+
Fatalities								
KIA (C)	0	0	0	0	0	0	0	0
DOW (CRN)	0	161	161	161	161	161	161	161
Sum of Fatalities	0	161	161	161	161	161	161	161
WIA								
GB(1)	18	0	0	0	0	0	0	0
GB(2)	39	39	0	0	0	0	0	0
GB(3)	1	23	23	23	23	23	0	0
GB(4)	184	0	0	0	0	0	0	0
Sum of WIA	241	63	23	23	23	23	0	0
CONV								
CONV (GB)	0	18	57	57	58	40	23	23
RTD								
RTD	0	0	0	0	0	18	57	58

\* Estimate is based on Casualty Criterion WIA(1+), a PAR of 816, Flag<sub>MT</sub> = Yes, and MT<sub>GB</sub> = FMT.

#### A.4. CHEMICAL AGENT: CK

1. The following excerpt from Table 1-5 shows which sections of AMedP-7.5 explain how to complete the five major steps for a CK casualty estimate.

Agent, Effect, or Disease	Five Steps			
	INPUT	CHALLENGE	RESPONSE/STATUS	REPORT
CK	Ch. 2	Ch. 3	Sections 4.2.12 and 4.1	Ch. 6

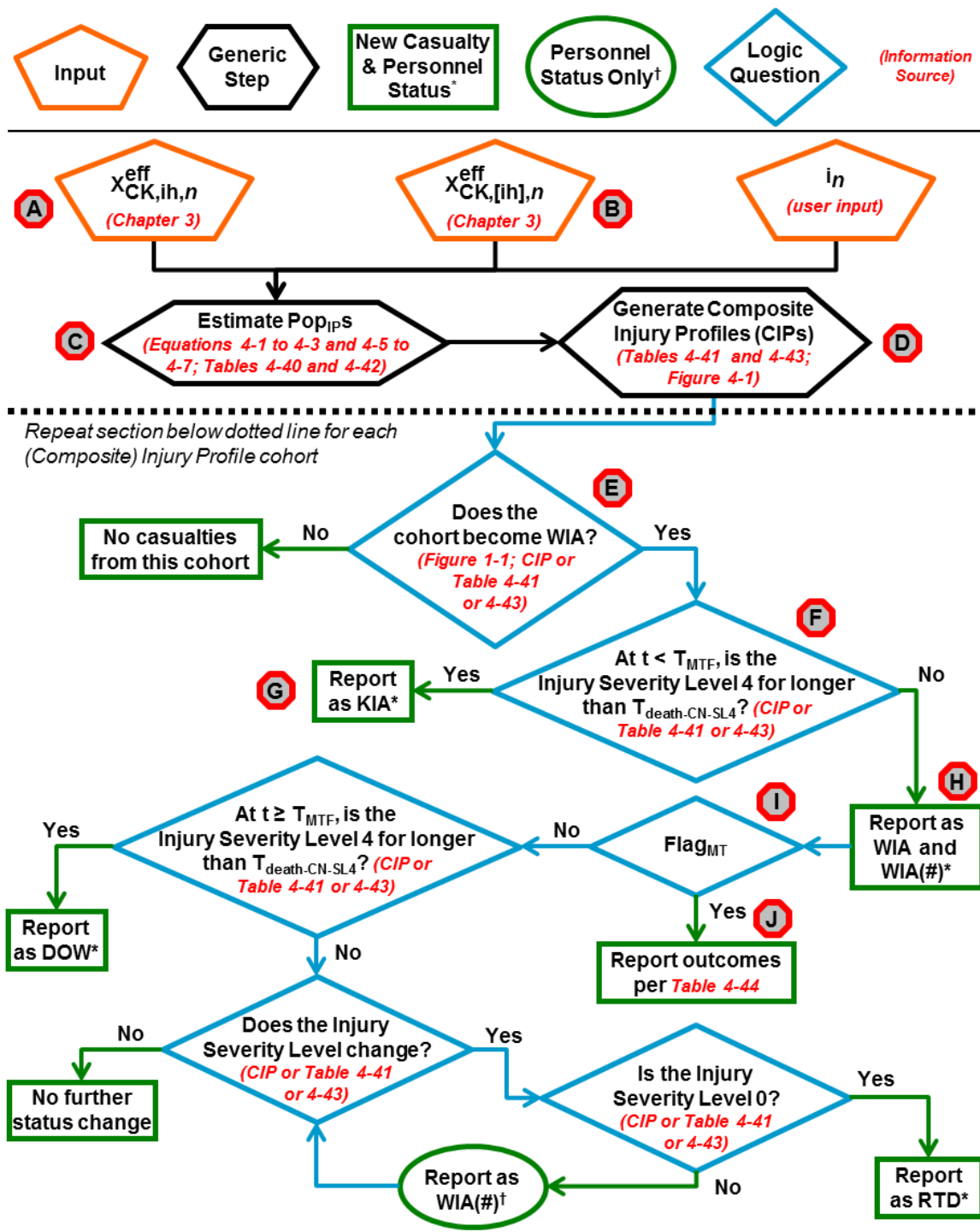

2. In order to more easily follow along with the example, it is recommended that the reader print and have available for reference the following figures and tables: Figure 1-1, Figure 1-3, the annotated version of Figure 4-13 located on the next page, Table 4-40 to Table 4-44, and Table A-1.



\* Casualty information ( $Pop_{IP}$ ,  $CAT$ ,  $f_{new-CAT}$ ,  $f_{ex-CAT}$ , and  $d$ ) is passed to Equations 4-17 and 4-19.  
† Personnel status information ( $Pop_{IP}$ ,  $CAT$ ,  $f_{new-CAT}$ ,  $f_{ex-CAT}$ , and  $d$ ) is passed to Equation 4-19.

Figure 4-13 Annotated for Illustrative Example

3. The red octagons containing a single letter in the annotated version of Figure 4-13 are user aids to help link the text later in the CK example to the various parts of the flowchart. Specifically, the red octagons are used to mark the *beginning* of the

text discussion related to the linked flowchart element. For example, the  on the first line of Section A.4.2 indicates that the discussion of the calculation of the Effective CBRN Challenge ( $X_{CK,ih,n}^{eff}$ ) begins there;  is linked to the calculation of  $X_{CK,ih,n}^{eff}$  because of its placement in the annotated version of Figure 4-13.

4. As noted in Table A-2, the CK example will illustrate the process for a casualty criterion of WIA(2+) and Flag<sub>MT</sub> = Yes. Further, as was demonstrated in the GB example, the available protective measures are so effective that if they are used, few if any casualties will occur. As the GB example already demonstrated how to determine protection factors, this example will use the “unprotected” case in which all personnel are treated as having no IPE and being outside of any assigned vehicle or shelter.

#### A.4.1. INPUT

1. The only INPUT needed that was not given in Section A.2 is the CBRN Challenge per icon over time. This step is not associated with a red octagon because it occurs in the flowchart of Figure 1-3, which is “upstream” of Figure 4-13. Finally, as stated in Section 2.1.2, the CBRN Challenge must be generated independently of AMedP-7.5, using national tools.

2. The simulated attack comprised 720 122 mm chemical rockets, each containing 2.4 kg of CK, for a total attack payload of 1728 kg CK. The aim point was approximately at the center of mass of the icons on the airfield, and all 720 rockets detonated within 125 meters of the target. The simulated attack occurred at 2000 hours on cultivated terrain. Meteorological conditions were no cloud cover, wind at an average speed of about 2 m/s from the southwest toward the northeast, and an average temperature of 20.7 °C. Figure A-3 is a qualitative depiction of the CBRN Challenge (cumulative) at the end of the simulation. Each filled red circle represents an icon in the task force, and the CK plume is depicted with colors indicating different amounts of CBRN Challenge (purple is low, red is high).

3. To generate the quantitative input needed for AMedP-7.5, the CBRN Challenge per icon was extracted from HPAC. For the concentration-time CBRN Challenge, the values were extracted at one-minute intervals. However, for the CBRN Challenge for concentration-based effects, the values were extracted at one-second intervals; this was necessary because the CBRN Challenge for concentration-based effects is an instantaneous value (per the definition—Section 1.4), and peaks in the instantaneous value are very short lived (on the order of seconds, not minutes).

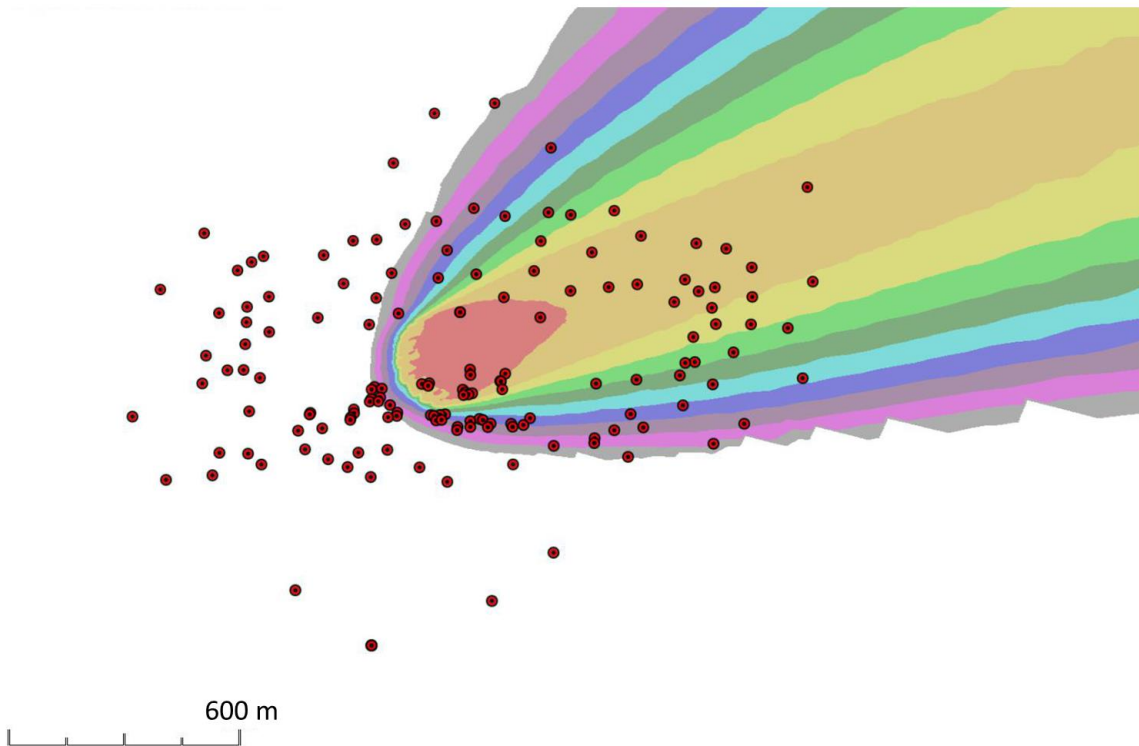

Figure A-3: CK Attack on Task Force

#### A.4.2. CHALLENGE

**A**

1. As indicated in Figure 4-13, the calculation of  $X_{CK,ih,n}^{eff}$  is done per Chapter 3.
2. Because the icon attributes do not change over time, the sum in Equation 3-1 needs only a single term; the sum does not need to be expanded into a term for each minute of challenge data. Thus, Equation 3-1 for any icon can be simplified to:

$$X_{CK,ih,n}^{eff} = \frac{(X_{CK,ih,n,30} - 0) \cdot Z_n}{1}, \quad (3-1)$$

where:

Minute 30 is chosen ( $X_{CK,ih,n,30}$ ) because the CBRN Challenge has stopped accumulating by that point, and

the APF, in the denominator, is set to 1 to model the unprotected case.

**B**

3. Similarly, Equation 3-2 can be simplified to:

$$X_{Q,n}^{\text{eff}} = \text{MAX} \left( \frac{X_{Q,n,t_k}}{1} \right), \text{ for } 0 \leq k \leq 1800, \quad (3-2)$$

where:

the maximum value of k is 1800 because at one-second time resolution, 1,800 time points are in 30 minutes.



4. Table A-10 shows the two Effective CBRN Challenges, calculated using the simplified forms of Equations 3-1 and 3-2 given above, for 8 selected icons. The Table A-10 values will be used to illustrate the RESPONSE, STATUS, and REPORT portions of the methodology.

**Table A-10: CK Effective CBRN Challenge for Selected Icons**

Icon # (n)	$X_{CK,ih,n}^{\text{eff}}$ [mg-min/m <sup>3</sup> ]	$X_{CK,[ih],n}^{\text{eff}}$ [mg/m <sup>3</sup> ]
3	840.33	2652
11	8.50	3.6
23	1062.50	549
48	1677.57	783
58	125.40	69
101	3531.00	1709
131	5470.33	14448
132	3307.83	6257

#### A.4.3. RESPONSE/STATUS



1. According to Figure 4-13, with  $X_{CK,ih,n}^{\text{eff}}$ ,  $X_{CK,[ih],n}^{\text{eff}}$ , and  $i_n$  now available for all icons, the next step is to calculate the population of the Injury Profile cohorts (Pop<sub>IPS</sub>), using Equations 4-1 to 4-3, 4-5 to 4-7, and Table 4-40 and Table 4-42.

a. Taking icon 132 as an example,  $X_{CK,ih,n}^{\text{eff}}$  is 3307.83 mg-min/m<sup>3</sup>. Applying Equation 4-1 for all four levels of effect (values of k) makes use of the toxicity parameters given in Table 4-40:

$$p_{CK,ih\_mild,132} = \Phi \left( 12 \cdot \log_{10} \left( \frac{3307.83}{1200} \right) \right) = 1.0$$

$$p_{CK,ih\_moderate,132} = \Phi \left( 12 \cdot \log_{10} \left( \frac{3307.83}{2100} \right) \right) = 0.991$$

$$p_{CK,ih\_severe,132} = \Phi \left( 12 \cdot \log_{10} \left( \frac{3307.83}{2800} \right) \right) = 0.807$$

$$p_{\text{CK,ih\_very severe},132} = \Phi \left( 12 \cdot \log_{10} \left( \frac{3307.83}{4700} \right) \right) = 0.034$$

- b. Recall that the values calculated above must now be used to determine which fraction of personnel has each value of  $k$  as their *worst* level of effect (to avoid double-counting). According to Equation 4-2:

$$p_{\text{w,CK,ih\_mild},132} = p_{\text{CK,ih\_mild},132} - p_{\text{CK,ih\_moderate},132} = 0.009$$

$$p_{\text{w,CK,ih\_moderate},132} = p_{\text{CK,ih\_moderate},132} - p_{\text{CK,ih\_severe},132} = 0.184$$

$$p_{\text{w,CK,ih\_severe},132} = p_{\text{CK,ih\_severe},132} - p_{\text{CK,ih\_very severe},132} = 0.773$$

$$p_{\text{w,CK,ih\_very severe},132} = p_{\text{CK,ih\_very severe},132} - 0 = 0.034$$

- c. For concentration-based effects, the calculation is simpler. Again taking icon 132 as an example,  $X_{\text{CK,[ih],n}}^{\text{eff}} = 6257 \text{ mg/m}^3$ . Applying Equation 4-3 for both effect levels makes use of the concentration ranges in Table 4-42.

$$p_{\text{w,CK,[ih]_{1-20}},132} = \begin{cases} 1 & \text{if } 1 \leq 6257 < 20 \\ 0 & \text{otherwise} \end{cases} = 0$$

$$p_{\text{w,CK,[ih]_{>20}},132} = \begin{cases} 1 & \text{if } 20 \leq 6257 \\ 0 & \text{otherwise} \end{cases} = 1$$

- d. Now Equations 4-5 to 4-7 must be used. They are intended to be used to sum over all icons. For brevity, an example of applying the equations to icon 132 (i.e., as if icon 132 was the entire PAR) alone is shown below.

- 1) Equation 4-5 determines the populations of the Composite Injury Profile cohorts. Using icon 132 alone:

$$\text{Pop}_{\text{IP,CK,ih\_mild,CK,[ih]_{1-20}}} = i_{132} \cdot (p_{\text{w,CK,ih\_mild},132} \cdot p_{\text{w,CK,[ih]_{1-20}},132}) = 1 \cdot (0.009 \cdot 0) = 0$$

$$\text{Pop}_{\text{IP,CK,ih\_mild,CK,[ih]_{>20}}} = 1 \cdot (0.009 \cdot 1) = 0.009$$

$$\text{Pop}_{\text{IP,CK,ih\_moderate,CK,[ih]_{1-20}}} = 1 \cdot (0.184 \cdot 0) = 0$$

$$\text{Pop}_{\text{IP,CK,ih\_moderate,CK,[ih]_{>20}}} = 1 \cdot (0.184 \cdot 1) = 0.184$$

$$\text{Pop}_{\text{IP,CK,ih\_severe,CK,[ih]_{1-20}}} = 1 \cdot (0.773 \cdot 0) = 0$$

$$\text{Pop}_{\text{IP,CK,ih\_severe,CK,[ih]_{>20}}} = 1 \cdot (0.773 \cdot 1) = 0.773$$

$$\text{Pop}_{\text{IP,CK,ih\_very severe,CK,[ih]_{1-20}}} = 1 \cdot (0.034 \cdot 0) = 0$$



$$\text{Pop}_{\text{IP,CK,ih\_very severe,CK,[ih]_{>20}}} = 1 \cdot (0.034 \cdot 1) = 0.034$$

- 2) Equation 4-6 is used to calculate the populations of the (non-composite) Injury Profiles for concentration-time based effects. For icon 132 alone:

$$\begin{aligned} \text{Pop}_{\text{IP,CK,ih\_mild}} &= i_{132} \cdot \left( p_{\text{w,CK,ih\_mild,132}} - \left( p_{\text{w,CK,ih\_mild,132}} \cdot p_{\text{w,CK,[ih]_{1-20,132}}} + p_{\text{w,CK,[ih]_{>20,132}} \cdot p_{\text{w,CK,ih\_mild,132}} \right) \right) \\ &= 1 \cdot (0.009 - (0.009 \cdot 0 + 0.009 \cdot 1)) = 0 \end{aligned}$$

$$\text{Pop}_{\text{IP,CK,ih\_moderate}} = 1 \cdot (0.184 - (0.184 \cdot 0 + 0.184 \cdot 1)) = 0$$

$$\text{Pop}_{\text{IP,CK,ih\_severe}} = 1 \cdot (0.773 - (0.773 \cdot 0 + 0.773 \cdot 1)) = 0$$

$$\text{Pop}_{\text{IP,CK,ih\_very severe}} = 1 \cdot (0.034 - (0.034 \cdot 0 + 0.034 \cdot 1)) = 0$$

- 3) Equation 4-7 is used to calculate the populations of the (non-composite) Injury Profiles for concentration based effects. For icon 132 alone:

$$\begin{aligned} \text{Pop}_{\text{IP,CK,[ih]_{1-20}}} &= i_{132} \cdot \left( p_{\text{w,CK,[ih]_{1-20,132}}} - \left( p_{\text{w,CK,[ih]_{1-20,132}} \cdot p_{\text{w,CK,ih\_mild,132}} + p_{\text{w,CK,[ih]_{1-20,132}} \cdot p_{\text{w,CK,ih\_moderate,132}} + p_{\text{w,CK,[ih]_{1-20,132}} \cdot p_{\text{w,CK,ih\_severe,132}} + p_{\text{w,CK,[ih]_{1-20,132}} \cdot p_{\text{w,CK,ih\_very severe,132}} \right) \right) \\ &= 1 \cdot (0 - (0 \cdot 0.009 + 0 \cdot 0.184 + 0 \cdot 0.773 + 0 \cdot 0.034)) = 0 \end{aligned}$$

$$\text{Pop}_{\text{IP,CK,[ih]_{>20}}} = 1 \cdot (1 - (1 \cdot 0.009 + 1 \cdot 0.184 + 1 \cdot 0.773 + 1 \cdot 0.034)) = 0$$

- 4) For icon 132 alone, the populations of all the non-composite Injury Profile cohorts are zero; however, such is not the case when all icons are included; see Table A-11.
- e. Applying Equations 4-1 to 4-3 and 4-5 to 4-7 to all 155 icons, instead of just icon 132, gives the results shown in Table A-11. Although in this case—and likely for most scenarios involving chemical agents with concentration-based effects, such as CG and CK—several Injury Profiles have zero population, this will usually not be true for agents that have two (or more) challenge types that both use median toxicities and probit slopes to calculate probabilities of effect (e.g., VX, HD).

**Table A-11: Injury Profile Cohort Populations for CK Illustrative Example**

Injury Profile	Cohort Population (from Equation 4-4)
Mild	0
Moderate	0
Severe	0
Very Severe	0
1–20 mg/m <sup>3</sup>	54.00
>20 mg/m <sup>3</sup>	190.63
Mild & 1–20 mg/m <sup>3</sup>	0
Mild & >20 mg/m <sup>3</sup>	36.84
Moderate & 1–20 mg/m <sup>3</sup>	0
Moderate & >20 mg/m <sup>3</sup>	23.07
Severe & 1–20 mg/m <sup>3</sup>	0
Severe & >20 mg/m <sup>3</sup>	26.84
Very Severe & 1–20 mg/m <sup>3</sup>	0
Very Severe & >20 mg/m <sup>3</sup>	23.87



2. Composite Injury Profiles for the profiles that are associated with a non-zero population must now be generated. This is done according to the flowchart in Figure 4-1. Because the process is straightforward, especially if Table 4-41 and Table 4-43 are available for reference, the results are simply shown below.

**Table A-12: Inhaled CK Composite Injury Profiles**

Time Point [min]	Injury Profile			
	Mild & > 20 mg/m <sup>3</sup>	Moderate & > 20 mg/m <sup>3</sup>	Severe & > 20 mg/m <sup>3</sup>	Very Severe & > 20 mg/m <sup>3</sup>
1	2	2	3	4
2	1	2	3	4
10	1	1	2	4
15	1	1	2	4*
120	0	1	1	
180	0	0	1	
480	0	0	0	

\* According to the default value for  $T_{\text{death-CN-SL4}}$ , death would be modeled at this point.



3. According to Figure 4-13, the next step is to answer the question “Does the cohort become WIA?”, for each cohort, using Figure 1-1 and the Injury Profiles (Table 4-41, Table 4-43, and Table A-12).

a. The casualty criterion is WIA(2+), so only cohorts involving Moderate, Severe, Very Severe, or >20 mg/m<sup>3</sup> will become WIA.

4. The text at the bottom of Figure 4-13 states that certain information is passed to Equations 4-17 and 4-19. The subparts of this paragraph will first summarize in plain text the information passed to the equations. Then, following the convention

listed at the bottom of Figure 4-13, the information passed to the equations will be listed in this format: **[Pop<sub>IP</sub>, CAT, f<sub>new-CAT</sub>, f<sub>ex-CAT</sub>, d]**.

**F**

- a. “At  $t < T_{MTF}$ , is the Injury Severity Level 4 for longer than  $T_{death-CN-SL4}$ ?”

**G**

- 1) For the Very Severe &  $>20 \text{ mg/m}^3$  cohort, yes. The Very Severe &  $>20 \text{ mg/m}^3$  cohort is reported as KIA on Day 1.  
**[23.87, KIA, 1.0, 0, 1]**

**H**

- 2) For all other cohorts, no, so the flowchart indicates “Report as WIA and WIA(#).” All other cohorts that satisfy the casualty criterion are reported as WIA on Day 1. Additionally, the  $>20 \text{ mg/m}^3$  and Moderate &  $>20 \text{ mg/m}^3$  cohorts are reported as WIA(2) on Day 1, and the Severe &  $>20 \text{ mg/m}^3$  cohort is reported as WIA(3) on Day 1.  
**[190.63, WIA or WIA(2), 1.0, 0, 1] ; [23.07, WIA or WIA(2), 1.0, 0, 1] ; [26.84, WIA or WIA(3), 1.0, 0, 1]**

**I**

- b. The value of Flag<sub>MT</sub> is Yes, per Table A-2. Thus, the next step is to “Report outcomes per Table 4-44.”

- 1) Unlike in the GB example, the availability of medical treatment does not save the lives of those in the Very Severe cohorts. This is because treatment for CK is only available at the MTF, whereas treatment for GB begins in the field with individual-issue antidotes. Thus, no change occurs for the Very Severe &  $>20 \text{ mg/m}^3$  cohort.

**J**

- 2) Table 4-44 indicates that all other cohorts will RTD on Day 2.  
**[190.63, WIA(2), 0, 1.0, 2] ; [190.63, RTD, 1.0, 0, 2]  
[23.07, WIA(2), 0, 1.0, 2] ; [23.07, RTD, 1.0, 0, 2]  
[26.84, WIA(3), 0, 1.0, 2] ; [26.84, RTD, 1.0, 0, 2]**

#### A.4.4. REPORT

1. Section A.4.3 stated the information that would be reported to Equations 4-17 and 4-19. This section will show how that information is used to populate the output tables.

2. As an example of the use of Equation 4-17, consider the application to determine the number of new RTD on Day 2, using the reporting information from Section A.4.3.3. The relevant reporting information is:

**[190.63, RTD, 1.0, 0, 2] ; [23.07, RTD, 1.0, 0, 2] ; [26.84, RTD, 1.0, 0, 2]**

$$\text{New}_{\text{RTD}}(2) = 190.63 \cdot 1.0 + 23.07 \cdot 1.0 + 26.84 \cdot 1.0 = 240.54 \approx 241 \quad (4-17)$$

The rate table (Table A-13) reports 241 casualties as new RTD on Day 2.

3. As an example of the use of Equation 4-19, consider the application to determine the total number of WIA(2) on Day 2, using the reporting information from Section A.4.3.3. Equation 4-19 requires that the value for the previous day be known:  $\text{Tot}_{\text{WIA}(2)}(1) = 213.70$ . Then, all reporting information for category WIA(2) and day 2 must be considered; the relevant reporting information is:

**[190.63, WIA(2), 0, 1.0, 2] ; [23.07, WIA(2), 0, 1.0, 2]**

$$\text{Tot}_{\text{WIA}(2)}(2) = 213.70 + (190.63 \cdot (0 - 1.0) + 23.07 \cdot (1.0 - 0)) = 0 \quad (4-19)$$

The personnel status table (Table A-14) reports 0 casualties as WIA(2) on Day 2.

4. To complete all entries in the reporting tables, Equations 4-17 and 4-19 must be applied for all casualty categories and all days until no further changes occur. As the logic involved in applying the equations has been demonstrated, and for brevity, the remainder of the calculations are not shown here.

5. Table A-13 and Table A-14 are the output tables for the CK example. Note that the estimates stop at Day 2 because no further changes in casualty status occur after Day 2.

**Table A-13: Estimated Daily Number of New CK Casualties\***

Casualty Description	Day 1	Day 2
New KIA (C)	24	0
New DOW (CRN)	0	0
Sum of New Fatalities	24	0
New WIA (CK)	241	0
New CONV (CK)	0	0
New RTD	0	241

\* Estimate is based on Casualty Criterion WIA(2<sup>+</sup>), a PAR of 816, Flag<sub>MT</sub> = Yes, and MT<sub>CK</sub> = AT.

**Table A-14: Estimated Personnel Status for CK Casualties\***

Casualty Description	Day 1	Day 2
Fatalities		
KIA (C)	24	24
DOW (CRN)	0	0
<b>Sum of Fatalities</b>	<b>24</b>	<b>24</b>
WIA		
CK(2)	214	0
CK(3)	27	0
<b>Sum of WIA</b>	<b>241</b>	<b>0</b>
CONV		
CONV (CK)	0	0
RTD		
RTD	0	241

\* Estimate is based on Casualty Criterion WIA(2+), a PAR of 816, Flag<sub>MT</sub> = Yes, and MT<sub>CK</sub> = AT.

### A.5. RDD: <sup>137</sup>CS

1. The following excerpt from Table 1-5 shows which sections of AMedP-7.5 explain how to complete the five major steps for a RDD casualty estimate.

Agent, Effect, or Disease	Five Steps			
	INPUT	CHALLENGE	RESPONSE/STATUS	REPORT
RDD	Ch. 2	Ch. 3 and Section 4.3.2.3	Sections 4.3.2 and 4.1	Ch. 6

2. In order to more easily follow along with the example, it is recommended that the reader print and have available for reference the following figures and tables: Figure 1-1, Figure 1-3, the annotated version of Figure 4-15 located on the next page, Table 4-49 to Table 4-54, and Table A-1.

3. The red octagons containing a single letter in the annotated version of Figure 4-15 are user aids to help link the text later in the RDD example to the various parts of the flowchart. Specifically, the red octagons are used to mark the *beginning* of the text discussion related to the linked flowchart element. For example, the **A** and **B** on the first line of Section A.5.2 indicate that the discussion of the calculation of the Effective CBRN Challenges ( $X_{RDD,wb,n}^{eff}$   $X_{RDD,cut,n}^{eff}$ ) begins there; **A** is linked to the calculation of  $X_{RDD,wb,n}^{eff}$  and **B** is linked to the calculation of  $X_{RDD,cut,n}^{eff}$  because of their placement in the annotated version of Figure 4-15.

4. As noted in Table A-2, the RDD example will illustrate the process for a casualty criterion of WIA(1+), Flag<sub>MT</sub> = Yes, and without including the effects of G-CSF as part of medical treatment. The full protection indicated in Table A-1 is included.



\* Casualty information ( $i_n$ , CAT,  $f_{new-CAT}$ ,  $f_{ex-CAT}$ , and d) is passed to Equations 4-18 and 4-20.

† Personnel status information ( $i_n$ , CAT,  $f_{new-CAT}$ ,  $f_{ex-CAT}$ , and d) is passed to Equation 4-20.

Figure 4-15 Annotated for Illustrative Example

### A.5.1. INPUT

1. The only INPUT needed that was not given in Section A.2 is the CBRN Challenge per icon over time. This step is not associated with a red octagon because it occurs in the flowchart of Figure 1-3, which is “upstream” of Figure 4-15. Finally, as stated in Section 2.1.2, the CBRN Challenge must be generated independently of AMedP-7.5, using national tools.
2. The simulated attack is a 1,000 kg high explosive<sup>97</sup> that disperses  $1.11 \times 10^5$  TBq of <sup>137</sup>Cs (equivalent to the typical source strength of an irradiator used for sterilization and food preservation). The point of detonation is 1 m above ground and less than 200 m west of the westernmost extent of the task force. The simulated attack occurred at 2000 hours on cultivated terrain. Meteorological conditions were no cloud cover, wind at an average speed of about 2 m/s from the southwest toward the northeast, and an average temperature of 20.7 °C. Figure A-4 is a qualitative depiction of the CBRN Challenge (cumulative) at the end of the simulation. Each filled red circle represents an icon in the task force, and the <sup>137</sup>Cs plume is depicted with colors indicating different amounts of CBRN Challenge (grey is low, yellow is high).
3. To generate the quantitative input needed for AMedP-7.5, the CBRN Challenge per icon was extracted from HPAC in one-minute intervals. As full protection is included for the entire challenge duration, only the final value of the CBRN Challenge—the value at 240 minutes—is needed for the calculations. Overall, very few icons received a challenge sufficient to cause casualties, and of those that did, only some of the dose ranges are represented. Thus, data for only 3 selected icons are shown in Table A-15.

---

<sup>97</sup> Direct effects of the explosive—i.e. trauma—are not modeled; only the effects of the dispersed <sup>137</sup>Cs are modeled.

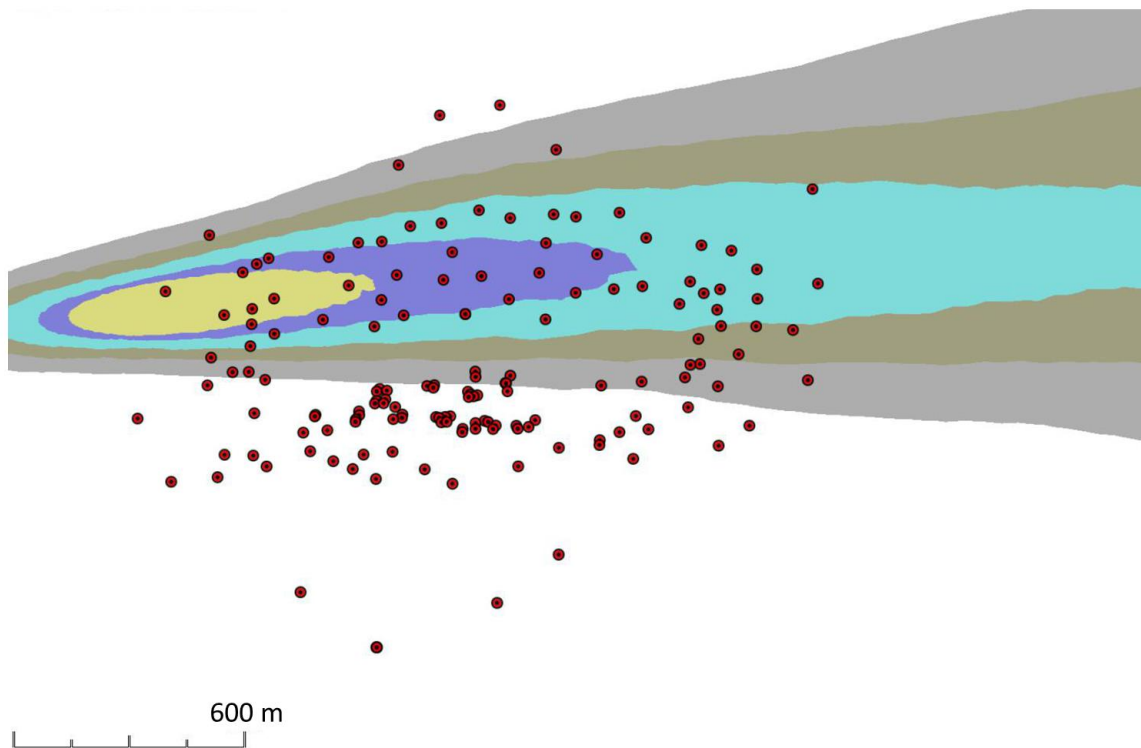

Figure A-4: <sup>137</sup>Cs RDD Attack on Task Force

Table A-15: RDD CBRN Challenge Data for Selected Icons

Icon # (n)	Contributors to $X_{RDD,wb,n}^{eff}$ [Gy]			Contributors to $X_{RDD,cut,n}^{eff}$ [Gy]		
	$X_{RDD,wb,cld,n,240}$ [TBq-min/m <sup>3</sup> ]	$X_{RDD,wb,grd,n,240}$ [TBq-min/m <sup>2</sup> ]	$X_{RDD,wb,ih,n,240}$ [TBq-min/m <sup>3</sup> ]	$X_{RDD,cut,cld,n,240}$ [TBq-min/m <sup>3</sup> ]	$X_{RDD,cut,grd,n,240}$ [TBq-min/m <sup>2</sup> ]	$X_{RDD,cut,s,n,240}$ [TBq-min/m <sup>3</sup> ]
1	0.00211	2.57255	0.00211	0.00211	2.57255	2.57255
26	0.00658	36.0650	0.00658	0.00658	36.0650	36.0650
36	0.00366	17.1343	0.00366	0.00366	17.1343	17.1343

### A.5.2. CHALLENGE



1. Section 4.3.2, and in particular Equations 4-23 to 4-25 and 4-27 to 4-29 indicate the need to sum over different isotopes to determine the total cloudshine, groundshine, inhalation, or skin contamination dose. As this example uses a single isotope (<sup>137</sup>Cs), such summing is unnecessary. Equation 3-1 will be used six times: once each for cloudshine, groundshine, and inhalation for the whole-body challenge, and once each for cloudshine, groundshine, and skin contamination for the cutaneous challenge.

2. Because the icon attributes do not change over time, the sum in Equation 3-1 needs only a single term; the sum does not need to be expanded into a term for each minute of challenge data. Thus, Equation 3-1 for any icon can be simplified to:



$$X_{RDD,Q,n}^{eff} = \frac{(X_{RDD,Q,n,60} - 0) \cdot Z}{APF_{RDD,Q,n}}, \quad (3-1)$$

where:

Minute 60 is chosen because all CBRN Challenges have stopped accumulating by that point,

Z will depend upon whether the challenge is cloudshine, groundshine, inhalation, or skin contamination (values are in Table 3-1),

The value of  $APF_{RDD,Q,n}$  is calculated according to Sections 2.1.5, 2.1.6, 2.1.7., and 2.1.9. The details depend upon the vehicle or shelter the icon occupies.

3. The value of the APF is specific to the challenge.
  - a. For cloudshine and groundshine challenges (components of both whole-body and cutaneous), only a vehicle or shelter might provide protection. As  $^{137}\text{Cs}$  emits primarily gamma radiation, protection factors from the gamma column of Table 2-7 are used. Icon 1 is in a Tent, and icons 26 and 36 are Exposed/Dismounted, all of which give no protection ( $APF = 1$ ).
  - b. For the inhalation challenge (a component of whole-body), the APF calculation is exactly the same as those demonstrated for the chemical agents—the process will not be demonstrated again here (see Sections A.3 and A.4 for details).
  - c. For the skin contamination challenge (a component of cutaneous), the only relevant protection factors are those on the right-most column of Table 2-4, and as none of the icons in this scenario are wearing Full Protection IPE, the APFs are 1.
4. Table A-16 shows the two Effective CBRN Challenges for each of the three selected icons. Icon 26 is the only icon with a whole-body dose sufficient to cause injury, and most other icons have cutaneous dose on the order or 10 Gy, such that they are in the same dose range as either Icon 1 or Icon 36.

**Table A-16: RDD Effective CBRN Challenge for Selected Icons**

Icon # (n)	$X_{RDD,wb,n}^{eff}$ [Gy]	$X_{RDD,cut,n}^{eff}$ [Gy]
1	0.10	4.4
26	1.28	61.9
36	0.61	29.4

**A.5.3. RESPONSE/STATUS**



1. According to Figure 4-15, the first step now that the Effective CBRN Challenges are known is to determine dose ranges.
  - a. Icon 1's dose ranges are < 1.25 Gy (WB) and 2 –< 15 Gy (cut).
  - b. Icon 26's dose ranges are 1.25 –< 3 Gy (WB) and 40 –< 550 Gy (cut)
  - c. Icon 36's dose ranges are < 1.25 Gy (WB) and 15 –< 40 Gy (cut).



2. The next step is to generate Composite Injury Profiles, as needed. Icons 1 and 36 do not need Composite Injury Profiles because they will not suffer a whole-body injury. For Icon 26, the Composite Injury Profile is generated using the scheme in Figure 4-1 with Table 4-50 and Table 4-53. The Composite Injury Profile is shown in Table A-17.

**Table A-17: Icon 26 Combined Injury Profile**

Time Point [hr]	1.25 –< 3 Gy (WB) and 40 –< 550 Gy (cut)
0.1	0
1	1
8	1
10	1
24	1
48	2
192	3

3. Table A-18 shows the number of individuals that belong to each possible dose range combination, across the entire task force. Icon 26 has a population of 7 personnel, and is the only icon represented by the 1.25 – < 3 Gy and 40 – < 550 Gy row.

**Table A-18: Dose Range Combination Distribution Across the Task Force**

Whole-Body Dose Range	Cutaneous Dose Range	Number of Individuals
< 1.25 Gy	< 2 Gy	575*
1.25 – < 3 Gy	< 2 Gy	0
≥ 3 Gy	< 2 Gy	0
< 1.25 Gy	2 – < 15 Gy	213
1.25 – < 3 Gy	2 – < 15 Gy	0
≥ 3 Gy	2 – < 15 Gy	0
< 1.25 Gy	15 – < 40 Gy	21
1.25 – < 3 Gy	15 – < 40 Gy	0
≥ 3 Gy	15 – < 40 Gy	0
< 1.25 Gy	40 – < 550 Gy	0
1.25 – < 3 Gy	40 – < 550 Gy	7
≥ 3 Gy	40 – < 550 Gy	0

Whole-Body Dose Range	Cutaneous Dose Range	Number of Individuals
< 1.25 Gy	≥ 550 Gy	0
1.25 – < 3 Gy	≥ 550 Gy	0
≥ 3 Gy	≥ 550 Gy	0

\* These individuals are not casualties.

4. For the next several steps, following the convention listed at the bottom of Figure 4-15, the information passed to the equations will be listed in this format: **[i<sub>n</sub>, CAT, f<sub>new-CAT</sub>, f<sub>ex-CAT</sub>, d]**.



5. The next step in Figure 4-15 is to determine whether the icons become WIA, and if so, report them as such. All three selected icons from Table A-16 become WIA(1) on Day 1.

**[4, WIA or WIA(1), 1.0, 0, 1] ; [7, WIA or WIA(1), 1.0, 0, 1]  
[7, WIA or WIA(1), 1.0, 0, 1]**



6. Because Flag<sub>MT</sub> = Yes, the next step is to report outcomes according to the medical treatment tables (Table 4-51 and/or Table 4-54).

a. For Icon 1, Table 4-51 indicates RTD on Day 3.

**[4, WIA(1), 0, 1.0, 3] ; [4, RTD, 1.0, 0, 3]**

b. For Icon 26, Table 4-51 indicates CONV on Day 3, and Table 4-54 indicates CONV on Day 2. The later date takes precedence.

**[7, WIA(1), 0, 1.0, 3] ; [7, CONV, 1.0, 0, 3]**

c. For Icon 36, Table 4-51 indicates RTD on Day 3.

**[7, WIA(1), 0, 1.0, 3] ; [7, RTD, 1.0, 0, 3]**

#### A.5.4. REPORT

1. Section A.5.3 stated the information that would be reported to Equations 4-18 and 4-20. This section will show how that information is used to populate the output tables.

2. As an example of the use of Equation 4-18, consider the application to determine the number of new WIA on Day 1, using the reporting information from Section A.5.3. All reporting information for category WIA and day 1 must be considered; the relevant reporting information is:

**[4, WIA or WIA(1), 1.0, 0, 1] ; [7, WIA or WIA(1), 1.0, 0, 1] ;  
[7, WIA or WIA(1), 1.0, 0, 1].**

$$\text{New}_{\text{WIA}}(1) = 4 \cdot 1.0 + 7 \cdot 1.0 + 7 \cdot 1.0 = 18 \quad (4-17)$$

The rate table (Table A-19) reports a larger number of casualties on Day 1

because it accounts for all icons.

3. As an example of the use of Equation 4-20, consider the application to determine the total number of WIA(1) on Day 3, using the reporting information from Section A.5.3. Equation 4-19 requires that the value for the previous day be known: for the three selected icons alone,  $Tot_{WIA(1)}(2) = 18$ . Then, all reporting information for category WIA(1) and Day 3 must be considered; the relevant reporting information is:

**[4, WIA(1), 0, 1.0, 3] ; [7, WIA(1), 0, 1.0, 2] ; [7, WIA(1), 0, 1.0, 2]**

$$Tot_{WIA(1)}(3) = 18 + (4 \cdot (0 - 1.0) + 7 \cdot (0 - 1.0) + 7 \cdot (0 - 1.0)) = 0 \quad (4-19)$$

The personnel status table (Table A-20) also reports zero casualties on day 3, even though it considers additional icons

4. To complete all entries in the reporting tables, Equations 4-18 and 4-20 must be applied for all casualty categories and all days until no further changes occur. As the logic involved in applying the equations has been demonstrated, and for brevity, the remainder of the calculations are not shown here.

5. Table A-19 and Table A-20 are the output tables. To demonstrate a different way of presenting results, “planning ranges” have been applied such that days 8–14 are combined, days 15–30 are combined, and days 31+ are combined. This is entirely flexible and user-specifiable.

**Table A-19: Estimated Daily Number of New <sup>137</sup>Cs RDD Casualties \***

Casualty Description	Day 1	Day 2	Day 3	Day 4	Day 5	Day 6	Day 7	Days 8–14	Days 15–30	Days 31+
New KIA (R)	0	0	0	0	0	0	0	0	0	0
New DOW (CRN)	0	0	0	0	0	0	0	0	0	0
Sum of New Fatalities	0	0	0	0	0	0	0	0	0	0
New WIA (RDD)	241	241	0	0	0	0	0	0	0	0
New CONV (RDD)	0	0	7	0	0	0	0	0	0	0
New RTD	0	0	234	0	0	0	0	0	0	0

\* Estimate is based on Casualty Criterion WIA(1+), a PAR of 816, and Flag<sub>MT</sub> = Yes w/o G-CSF.

**Table A-20: Estimated Personnel Status for <sup>137</sup>Cs RDD Casualties\***

Casualty Description	Day 1	Day 2	Day 3	Day 4	Day 5	Day 6	Day 7	Days 8-14	Days 15-30	Days 31+
Fatalities										
KIA—N	0	0	0	0	0	0	0	0	0	0
DOW—CRN	0	0	0	0	0	0	0	0	0	0
<b>Sum of Fatalities</b>	0	0	0	0	0	0	0	0	0	0
WIA										
RDD(1)	241	241	0	0	0	0	0	0	0	0
<b>Sum of WIA</b>	241	241	0	0	0	0	0	0	0	0
CONV										
CONV (RDD)	0	0	7	7	7	7	7	7	7	7
RTD										
RTD	0	0	234	234	234	234	234	234	234	234

\* Estimate is based on Casualty Criterion WIA(1+), a PAR of 816, and Flag<sub>MT</sub> = Yes w/o G-CSF.



## A.6. NUCLEAR DETONATION: 10 KT GROUND BURST



1. The following excerpt from Table 1-5 shows which sections of AMedP-7.5 explain how to complete the five major steps for a nuclear casualty estimate.

Agent, Effect, or Disease	Five Steps			
	INPUT	CHALLENGE	RESPONSE/STATUS	REPORT
Initial Whole-Body Radiation	Ch. 2	Ch. 3 and Section 4.4.2.2	Sections 4.4.2 and 4.1	Ch. 6
Blast	Ch. 2	Ch. 3	Sections 4.4.3 and 4.1	Ch. 6
Thermal Fluence	Ch. 2	Section 4.4.4.2	Sections 4.4.4 and 4.1	Ch. 6

2. In order to more easily follow along with the example, it is recommended that the reader print and have available for reference the following figures and tables: Figure 1-1, Figure 1-3, Table A-1, the annotated version of Figure 4-17 and Table 4-52 to Table 4-54 (initial whole-body radiation), the annotated version of Figure 4-18 and Table 4-55 to Table 4-57 (blast), and the annotated version of Figure 4-19 and Table 4-59 to Table 4-62 (thermal).

3. The red, green, and blue octagons containing a single letter in the annotated versions of Figure 4-17, Figure 4-18, Figure 4-19, respectively, are user aids to help link the text later in the nuclear example to the various parts of the flowcharts. Specifically, the different coloured octagons are used to mark the *beginning* of the

text discussion related to the linked flowchart element. For example, the  and  on the first line of Section A.6.2 indicate that the discussion of the calculation of the

Effective CBRN Challenges ( $X_{nuc,wb,n}^{eff}$  and  $X_{nuc,blast,n}^{eff}$ ) begins there;  and  are linked to the calculation of  $X_{nuc,wb,n}^{eff}$  and  $X_{nuc,blast,n}^{eff}$ , respectively, because of their placement in the annotated versions of Figure 4-17 and Figure 4-18.

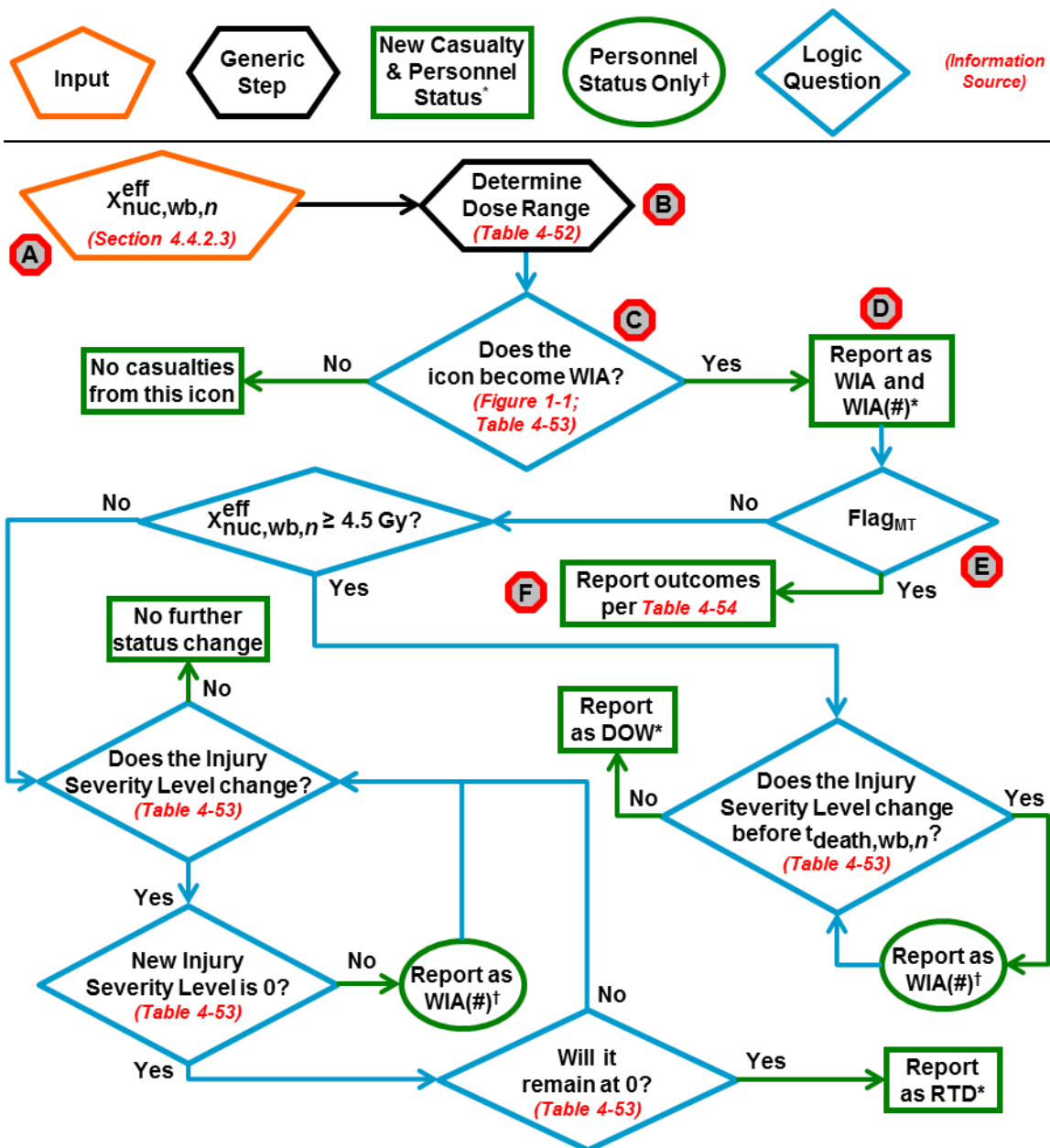

\* Casualty information ( $i_n$ , CAT,  $f_{new-CAT}$ ,  $f_{ex-CAT}$ , and  $d$ ) is passed to Equations 4-18 and 4-20.

† Personnel status information ( $i_n$ , CAT,  $f_{new-CAT}$ ,  $f_{ex-CAT}$ , and  $d$ ) is passed to Equation 4-20.

Figure 4-17 Annotated for Illustrative Example

4. As noted in Table A-2, the nuclear example will illustrate the process for a casualty criterion of WIA(1<sup>+</sup>), Flag<sub>MT</sub> = Yes, and without including the effects of G-CSF as part of medical treatment. The full protection indicated in Table A-1 is included.

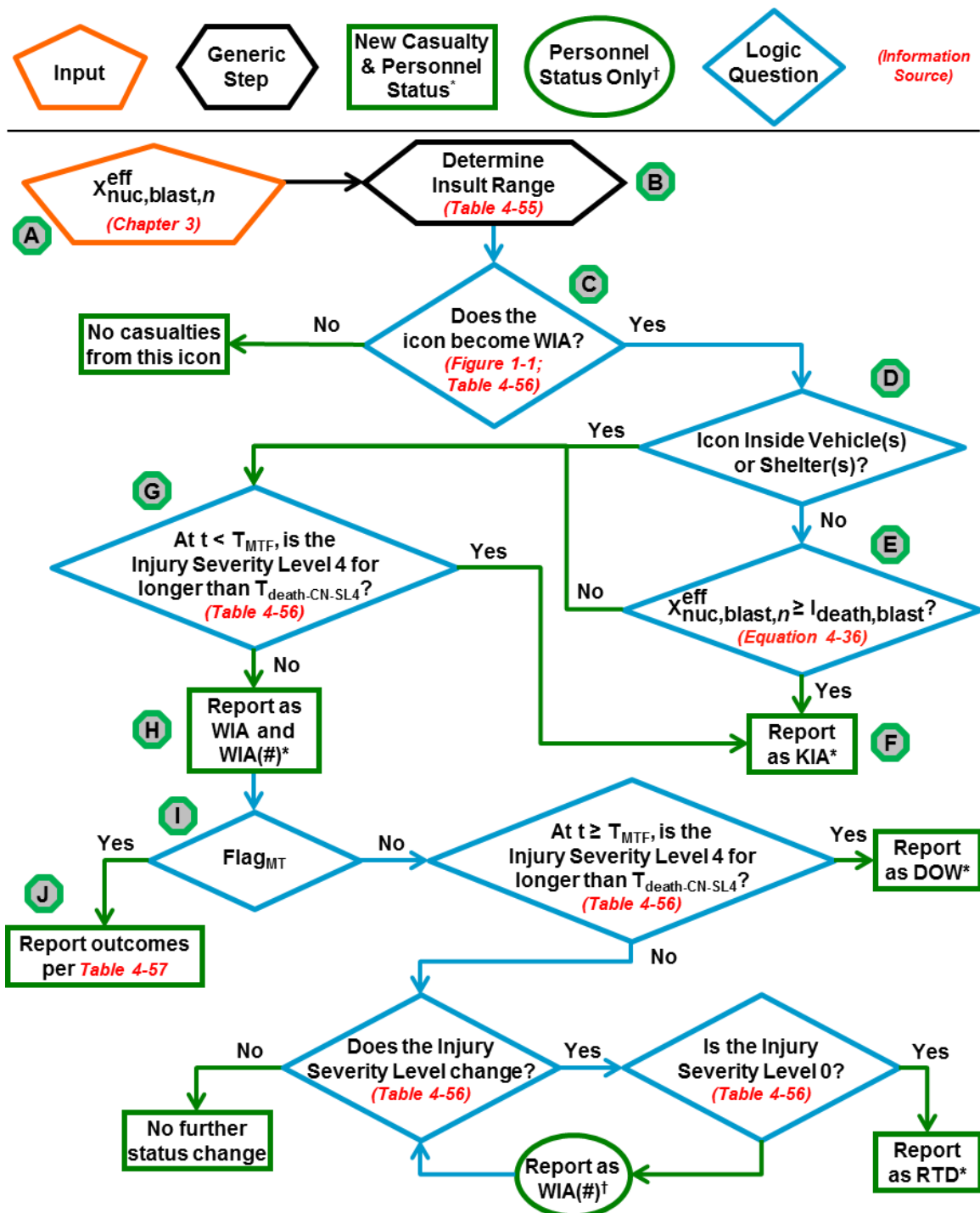

\* Casualty information ( $i_n$ , CAT,  $f_{new-CAT}$ ,  $f_{ex-CAT}$ , and d) is passed to Equations 4-18 and 4-20.

† Personnel status information ( $i_n$ , CAT,  $f_{new-CAT}$ ,  $f_{ex-CAT}$ , and d) is passed to Equation 4-20.

Figure 4-18 Annotated for Illustrative Example



\* Casualty information ( $i_{nuc,therm,n}$ , CAT,  $f_{new-CAT}$ ,  $f_{ex-CAT}$ , and d) is passed to Equations 4-18 and 4-20.  
 † Personnel status information ( $i_{nuc,therm,n}$ , CAT,  $f_{new-CAT}$ ,  $f_{ex-CAT}$ , and d) is passed to Equation 4-20.

Figure 4-19 Annotated for Illustrative Example

### A.6.1. INPUT

1. The only INPUT needed that was not given in Section A.2 is the CBRN Challenge per icon. The value is not described as “over time” because prompt nuclear effects occur nearly instantaneously. This step is not associated with a coloured octagon because it occurs in the flowchart of Figure 1-3, which is “upstream” of Figure 4-17, Figure 4-18, Figure 4-19. Finally, as stated in Section 2.1.2, the CBRN Challenge must be generated independently of AMedP-7.5, using national tools.

2. The simulated attack was a 10 kT ground burst (height of burst = 1 m) detonated



at the gate leading into the base. Conditions specified for the purpose of estimating the CBRN Challenges were air density of  $1.225 \text{ kg/m}^3$ , air moisture content of 0.565%, “clear” visibility of 15 km, an atmospheric scattering factor of 1.65, and a thermal absorption factor of 2.45. Figure A-5 depicts selected nuclear effects circles (representing CBRN Challenge) overlaid on the task force represented as filled red circles that each represent one icon.

3. Table A-21 shows the CBRN Challenge data for 6 selected icons.

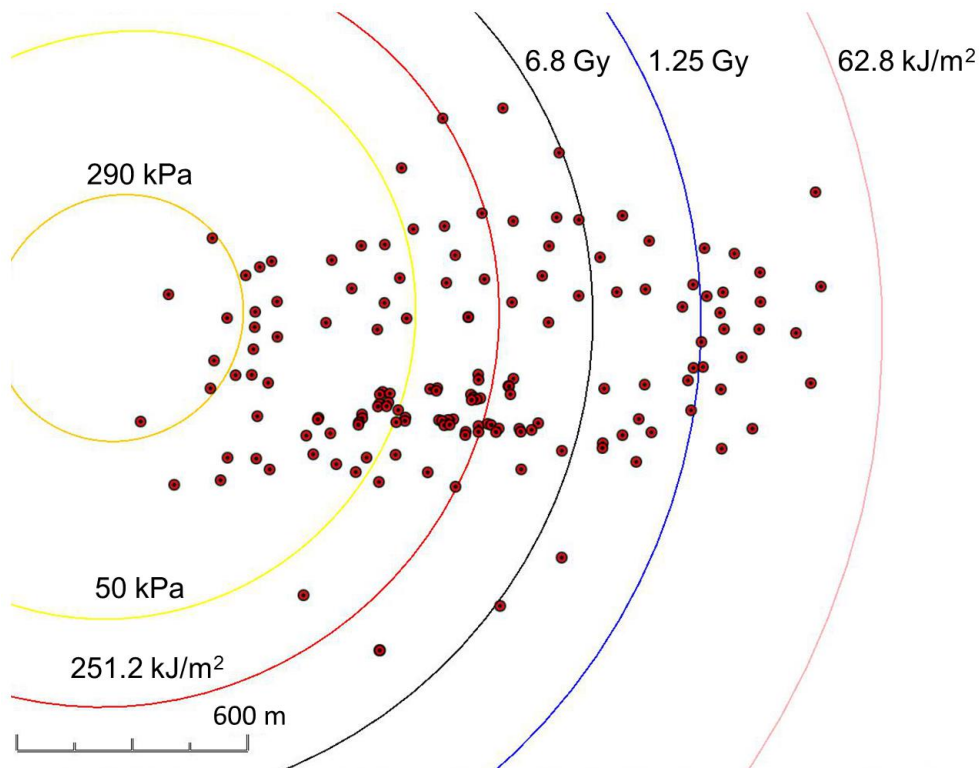

Figure A-5: 10 kT Ground Nuclear Attack on Task Force

Table A-21: Nuclear CBRN Challenge Data for Selected Icons

Icon # ( <i>n</i> )	$X_{\text{nuc,wb},n^0,n}$ [Gy]	$X_{\text{nuc,wb},\gamma,n}$ [Gy]	$X_{\text{nuc,blast},n}$ [kPa]	$X_{\text{nuc,thermal},n}$ [kJ/m <sup>2</sup> ]
23	4.92	1.39	21.99	272.90
36	18,700	811	298.69	4589.52
81	0.376	0.217	15.29	161.41
102	0.861	0.392	17.03	189.44
119	280	30.8	51.09	789.10
153	61.0	9.32	35.18	30.69

## A.6.2. CHALLENGE



1. Because nuclear challenges occur instantaneously, the sum in Equation 3-1 needs only a single term. Further, the special factor *Z* is not used for nuclear

challenges—its value is set to 1. Thus Equation 3-1, which only applies for radiation and blast calculations (a different equation is used for thermal), can be simplified to:

$$X_{nuc,Q,n}^{eff} = \frac{X_{nuc,Q,n}}{APF_{nuc,Q,n}} \quad (3-1)$$

2. In general, the value of the APF is calculated according to Sections 2.1.5, 2.1.6, 2.1.7., and 2.1.9. However, IPE (Section 2.1.5) and pre-exposure prophylaxis (Section 2.1.7) have no protective effects against nuclear challenges. Thus, the APF will be equal to the PF from the vehicle or shelter occupied (see Equation 2-2); determining the APF for each challenge type is as simple as looking up a value in Table 2-7 or Table 2-8. Note that Table 2-8 indicates a default blast protection factor of 1 for all vehicles and shelters (users can input different values based on national data, if desired).



3. For thermal challenges, the Effective CBRN Challenge is calculated using Equation 4-38; it depends upon the threshold thermal fluence for the type of uniform being worn (Table 4-59) and the fraction of skin covered by the uniform. As is recommended in the notes explaining Equation 4-38, this example assumes 88% of the skin is covered by uniform. All personnel in the scenario are wearing a BDU + T-shirt, which has a thermal fluence threshold of 310 kJ/m<sup>2</sup>. Thus, Equation 4-38 is:

$$X_{nuc,thermal,n}^{eff} = \frac{\arccos\left(\frac{310}{X_{nuc,thermal,n}}\right)}{\pi} \cdot 0.88 + \frac{\arccos\left(\frac{109}{X_{nuc,thermal,n}}\right)}{\pi} \cdot 0.12, \quad (4-38)$$



4. Table A-22 shows the APFs, uniform thermal fluence thresholds and Effective Challenges for each of the selected icons from Table A-21.

**Table A-22: Calculation of Nuclear Effective CBRN Challenge for Selected Icons**

Icon # (n)	APFs			Q <sub>T,uniform,n</sub>	X <sub>nuc,wb,n</sub> <sup>eff</sup> [Gy]	X <sub>nuc,blast,n</sub> <sup>eff</sup> [kPa]	X <sub>nuc,thermal,n</sub> <sup>eff</sup> [% BSA]
	n <sup>0</sup>	γ	Blast	Thermal			
23	1	1	1	310	6.31	21.99	4.43
36	1	1	1	310	19511	298.69	48.02
81	1.22	2.7	1	310	0.389	15.29	3.17
102	1	1	1	310	1.253	17.03	3.66
119	1.39	1.22	1	310	226.68	51.09	38.16
153	1	1	1	310	70.32	35.18	30.69

3. The Effective CBRN Challenges given in Table A-22 will be used to illustrate the RESPONSE, STATUS, and REPORT portions of the methodology.

4. Table A-23 shows the three Effective CBRN Challenges for each icon, along with the number of individuals in each icon who did and did not receive thermal challenge (the latter based on Equation 4-37).

**Table A-23: Nuclear Example Effective Challenge Summary for Task Force**

Icon #	$X_{nuc,wb,n}^{eff}$ [Gy]	$X_{nuc,blast,n}^{eff}$ [kPa]	$i_{nuc,therm,n}$	$i_n - i_{nuc,therm,n}$	$X_{nuc,thermal,n}^{eff}$ [% BSA]
1	101.5	38.3	1	3	32.9
2	7209	168.8	1	3	46.7
3	19.2	28.5	0.25	0.75	22.9
4	1.1	16.7	1	3	3.6
5	20.1	28.8	0.25	0.75	23.3
6	61.6	45.4	0.35	6.65	36.3
7	17.7	33.9	0.35	6.65	29.6
8	18.6	26.7	7	0	19.1
9	9.3	23.5	7	0	4.6
10	124.8	40.2	7	0	34
11	17.2	33.6	0.35	6.65	29.4
12	473	85.5	0.35	6.65	43.4
13	740.3	66.7	7	0	41.3
14	69.7	46.9	0.35	6.65	36.9
15	35.7	39.7	0.35	6.65	33.7
16	301.4	72.9	0.35	6.65	42.1
17	333.7	52.2	7	0	38.5
18	8.7	29.3	0.35	6.65	24.1
19	12.8	24.9	7	0	13
20	1.1	20.3	0.35	6.65	4.2
21	2.6	19	7	0	4
22	15.9	25.9	7	0	16.9
23	6.3	22	7	0	4.4
24	614.2	94.3	0.35	6.65	44
25	3684.6	217.9	0.35	6.65	47.4
26	176160	1826.7	7	0	49.5
27	28070	378	7	0	48.4
28	1700	145.8	0.35	6.65	46.1
29	2762.9	186.3	0.35	6.65	47
30	1255.4	79.9	7	0	42.9
31	1935	93.8	7	0	44
32	426	82	0.35	6.65	43.1
33	9873	199.7	7	0	47.1
34	802.2	104.7	0.35	6.65	44.6
35	7564	172.7	7	0	46.7
36	19511	298.7	7	0	48
37	4351.9	239.5	0.35	6.65	47.6
38	2933.3	191.6	0.35	6.65	47
39	2097.9	161.7	0.35	6.65	46.5
40	9582	196.1	7	0	47.1

Icon #	$X_{nuc,wb,n}^{eff}$ [Gy]	$X_{nuc,blast,n}^{eff}$ [kPa]	$i_{nuc,therm,n}$	$i_n - i_{nuc,therm,n}$	$X_{nuc,thermal,n}^{eff}$ [% BSA]
41	1817.1	150.3	0.35	6.65	46.3
42	0.2	12.9	7	0	1.9
43	0	13	0.35	6.65	2
44	0.3	13.6	7	0	2.4
45	0.1	14.5	0.35	6.65	2.9
46	0.2	16	0.35	6.65	3.4
47	0.3	16.5	0.35	6.65	3.5
48	1	16.6	7	0	3.5
49	0.2	15.5	0.35	6.65	3.2
50	0.4	14.7	7	0	2.9
51	0.1	14.7	0.35	6.65	2.9
52	0.3	17.1	0.35	6.65	3.7
53	0.8	15.9	7	0	3.4
54	0.4	14.7	7	0	2.9
55	0.6	15.2	7	0	3.1
56	0.7	15.7	7	0	3.3
57	1.1	16.7	7	0	3.6
58	0.2	15.9	0.35	6.65	3.3
59	1.2	16.9	7	0	3.6
60	20.3	34.9	0.35	6.65	30.4
61	12.7	24.9	7	0	12.7
62	3.6	24.9	0.35	6.65	12.7
63	5	21.1	7	0	4.3
64	0.9	19.8	0.35	6.65	4.2
65	541.4	60.3	7	0	40.3
66	98.5	51.6	0.35	6.65	38.3
67	38.1	40.3	0.35	6.65	34
68	61.5	34.2	7	0	29.8
69	13.1	25	7	0	13.3
70	7.5	22.6	7	0	4.5
71	3.9	20.3	7	0	4.2
72	22.9	35.9	0.35	6.65	31.2
73	58.1	35.9	12	0	31.2
74	2692.9	118.4	12	0	45.3
75	1.1	17.6	12	0	3.8
76	343.9	56.6	2	0	39.5
77	6.3	23.2	2	0	4.5
78	667.6	69.9	2	0	41.8
79	3623.5	135.5	2	0	45.9
80	0.7	16.6	2	0	3.5
81	0.4	15.3	2	0	3.2
82	161.6	45.9	2	0	36.5
83	2.8	20.4	2	0	4.2
84	1184.2	87.2	3	1	43.5
85	11382	256.7	3	1	47.7

Icon #	$X_{nuc,wb,n}^{eff}$ [Gy]	$X_{nuc,blast,n}^{eff}$ [kPa]	$i_{nuc,therm,n}$	$i_n - i_{nuc,therm,n}$	$X_{nuc,thermal,n}^{eff}$ [% BSA]
86	24.6	30	3	1	25.3
87	0.1	13.1	3	1	2.1
88	39	33	3	1	28.8
89	2.1	19.5	4	0	4.1
90	1.7	18.9	4	0	4
91	1.3	18.1	4	0	3.9
92	17.1	26.3	0.5	1.5	17.9
93	1.5	18.4	4	0	3.9
94	382.1	58.5	10	0	39.9
95	14.2	25.4	0.5	1.5	15.1
96	211.9	49.3	10	0	37.6
97	13.2	25.1	0.5	1.5	13.6
98	355	57.3	10	0	39.7
99	24.8	29.9	10	0	25.1
100	13.8	26.7	10	0	19.1
101	11.9	26	10	0	17
102	1.3	17	2.5	7.5	3.7
103	9	23.6	9	1	4.6
104	34.4	30.5	0.2	3.8	25.9
105	4.5	21	9	1	4.3
106	45.5	32	4	0	27.7
107	2	19.3	10	0	4.1
108	26.3	28.6	0.25	0.75	23
109	2.4	18.9	9	1	4
110	32.3	29.8	1	0	24.9
111	4.7	21.1	9	1	4.3
112	247.9	68.2	0.15	2.85	41.5
113	207.3	45.8	1	3	36.5
114	129.2	40.6	1	3	34.2
115	209.7	68.1	7.5	2.5	41.5
116	139.5	59.9	7.5	2.5	40.2
117	185.6	48.4	0.25	0.75	37.4
118	178.5	47.9	0.25	0.75	37.2
119	226.7	51.1	0.25	0.75	38.2
120	88.7	50.1	0.05	0.95	37.9
121	57.5	44.7	0.05	0.95	36
122	151.2	42.2	1	0	35
123	128.9	43.9	0.25	0.75	35.7
124	76.6	38.6	0.25	0.75	33.1
125	36.6	32.6	0.25	0.75	28.4
126	338.5	53.1	0.15	2.85	38.7
127	330.3	52.8	0.2	3.8	38.6
128	76.4	35.8	1	3	31.2
129	65	34.9	0.2	3.8	30.5
130	62.5	34.3	1	3	29.9

Icon #	$X_{nuc,wb,n}^{eff}$ [Gy]	$X_{nuc,blast,n}^{eff}$ [kPa]	$i_{nuc,therm,n}$	$i_n - i_{nuc,therm,n}$	$X_{nuc,thermal,n}^{eff}$ [% BSA]
131	6.6	33.1	0.5	1.5	28.8
132	5.7	32.1	0.25	0.75	27.8
133	6.3	32.7	0.25	0.75	28.5
134	18.8	28.4	0.25	0.75	22.7
135	17.8	26.5	0.5	1.5	18.5
136	11.1	30.7	0.25	4.75	26.2
137	30.1	29.4	0.25	0.75	24.3
138	25.7	28.4	0.25	0.75	22.8
139	13.2	31.8	0.15	2.85	27.6
140	797.2	68.3	4	0	41.5
141	217.2	50.6	0.25	0.75	38
142	209.3	50	0.25	0.75	37.8
143	178.5	47.9	0.25	0.75	37.2
144	147.2	42.5	0.05	0.95	35.1
145	76.6	38.6	0.25	0.75	33
146	88	39.9	0.25	0.75	33.8
147	38	32.8	0.25	0.75	28.6
148	333.3	52.9	0.15	2.85	38.6
149	112.1	53.5	0.15	2.85	38.8
150	27.6	28.8	0.25	0.75	23.5
151	63.8	34.4	1.5	4.5	30.1
152	77.1	36.3	0.05	0.95	31.6
153	70.3	35.2	1.5	4.5	30.7
154	6.1	32.6	0.25	0.75	28.3
155	5.4	31.7	0.25	0.75	27.4

### A.6.3. RESPONSE/STATUS

1. A key difference between nuclear and other casualty estimation is that for nuclear, three separate challenge types—three separate flowcharts (Figure 4-17, Figure 4-18, and Figure 4-19)—must be considered simultaneously. This section will demonstrate the process for a few example icons. For brevity and clarity, the Injury Severity Levels associated with the different challenges will be reported as R#, B#, and T#. For example, an icon could be R3, B2, T3.

2. Before getting to the chosen example icons, the second step on each flowchart is to determine the dose or insult range. Since all three challenges must be considered, each icon must be assigned to three different ranges. Table A-24 shows the number of individuals in each possible combination of dose and insult ranges for this illustrative example. The dose and insult ranges listed in Table A-24 are different from the Injury Profiles because the table takes into account the ranges listed in both the Injury Profiles and the medical treatment outcome reporting tables. The data in these tables are shown so that, if desired, a user can reconstruct the final casualty estimate presented in Section A.6.4.

Table A-24: Nuclear Example Effective Challenge Summary for Task Force

$X_{nuc,wb,n}^{eff}$ [Gy]	$X_{nuc,blast,n}^{eff}$ [kPa]	$X_{nuc,thermal,n}^{eff}$ [% BSA]						
		< 1	1 –< 10	10 –< 15	15 –< 20	20 –< 30	30 –< 45	≥ 45
0 –< 1.25	0 –< 50	70.5	93.5	0	0	0	0	0
1.25 –< 3	0 –< 50	8.5	46.5	0	0	0	0	0
3 –< 4.5	0 –< 50	6.65	7	0.35	0	0	0	0
4.5 –< 6.8	0 –< 50	6.5	34	0	0	1.5	0	0
6.8 –< 8.3	0 –< 50	0	7	0	0	0	0	0
8.3 –< 8.5	0 –< 50	0	0	0	0	0	0	0
≥ 8.5	0 –< 50	122.9	16	21.5	35.5	32.9	43.2	0
0 –< 1.25	50 –< 140	0	0	0	0	0	0	0
1.25 –< 3	50 –< 140	0	0	0	0	0	0	0
3 –< 4.5	50 –< 140	0	0	0	0	0	0	0
4.5 –< 6.8	50 –< 140	0	0	0	0	0	0	0
6.8 –< 8.3	50 –< 140	0	0	0	0	0	0	0
8.3 –< 8.5	50 –< 140	0	0	0	0	0	0	0
≥ 8.5	50 –< 140	64.3	0	0	0	0	84.7	14
0 –< 1.25	140 –< 240	0	0	0	0	0	0	0
1.25 –< 3	140 –< 240	0	0	0	0	0	0	0
3 –< 4.5	140 –< 240	0	0	0	0	0	0	0
4.5 –< 6.8	140 –< 240	0	0	0	0	0	0	0
6.8 –< 8.3	140 –< 240	0	0	0	0	0	0	0
8.3 –< 8.5	140 –< 240	0	0	0	0	0	0	0
≥ 8.5	140 –< 240	49.55	0	0	0	0	0	24.45
0 –< 1.25	240 –< 290	0	0	0	0	0	0	0
1.25 –< 3	240 –< 290	0	0	0	0	0	0	0
3 –< 4.5	240 –< 290	0	0	0	0	0	0	0
4.5 –< 6.8	240 –< 290	0	0	0	0	0	0	0
6.8 –< 8.3	240 –< 290	0	0	0	0	0	0	0
8.3 –< 8.5	240 –< 290	0	0	0	0	0	0	0
≥ 8.5	240 –< 290	1	0	0	0	0	0	3
0 –< 1.25	≥ 290	0	0	0	0	0	0	0
1.25 –< 3	≥ 290	0	0	0	0	0	0	0
3 –< 4.5	≥ 290	0	0	0	0	0	0	0
4.5 –< 6.8	≥ 290	0	0	0	0	0	0	0
6.8 –< 8.3	≥ 290	0	0	0	0	0	0	0
8.3 –< 8.5	≥ 290	0	0	0	0	0	0	0
≥ 8.5	≥ 290	0	0	0	0	0	0	21

3. Similar to the previous examples, the information that would be reported to Equations 4-18 and 4-20 by the radiation, blast, and thermal flowcharts is listed following the convention: **[i<sub>n</sub> or i<sub>nuc,therm,n</sub>, CAT, f<sub>new-CAT</sub>, f<sub>ex-CAT</sub>, d]**.

4. First take icon 102 as an example.



- a. The next step in each flowchart is to determine the dose or insult range. Icon 102 is in the 1.25 –< 3 Gy dose range, the 0 –< 50 kPa insult range, and the 1 –< 10% BSA insult range.



- b. The thermal flowchart (Figure 4-19) then requires calculation of  $i_{nuc,therm,n}$  per Equation 4-37.  $P_{trans}$  is 0.25 because icon 102 is in a tent (see Table 4-58). Thus, of the 10 personnel in icon 102, 2.5 receive the thermal challenge, and 7.5 do not.



- c. All three flowcharts then ask whether the personnel become casualties, and the answer is yes for radiation and thermal, but no for blast; the blast flowchart no longer needs to be considered for icon 102.



- d. The thermal flowchart asks whether the Injury Severity Level is at 4 for too long (No).



- e. The next step of the radiation and thermal flowcharts is to report WIA status. The entire icon will become WIA, but the icon must be split into two populations to reflect the different thermal exposures

**[2.5, WIA or WIA(R1, B0, T1), 1.0, 0, 1]**

**[7.5, WIA or WIA(R1, B0, T0), 1.0, 0, 1]**



- f. As  $Flag_{MT} = \text{Yes}$ , the next step is to report outcomes per Table 4-54 and Table 4-62.

- 1) For the radiation injury, icon 102 would be reported as CONV on Day 2 (Table 4-54) and would remain there indefinitely. As 7.5 personnel only have a radiation injury, those 7.5 are CONV on Day 2.

**[7.5, WIA(R1, B0, T0), 0, 1.0, 2] ; [7.5, CONV, 1.0, 0, 2]**

- 2) The other 2.5 personnel also have a thermal injury, and Table 4-62 reports that they are RTD on Day 15. Following the guidance under paragraph 2 of Section 6.3 and the rule from paragraph 6.b of Section 4.1.1, no changes in Injury Severity Level over time are reported until the casualties become DOW, CONV, or RTD. Although the radiation table indicates CONV on Day 2, the thermal table takes precedence and the icon must remain WIA until Day 15. On Day 15 the thermal table indicates RTD, but the radiation table indicates indefinite CONV, so the 2.5 personnel cannot be RTD—they are



CONV(R).

[2.5, WIA(R1, B0, T1), 0, 1.0, 15] ; [2.5, CONV(R), 1.0, 0, 15]

5. Next consider icon 36.



- a. The dose and insult ranges for icon 36 are  $\geq 8.3$  Gy,  $\geq 290$  kPa, and  $\geq 30\%$  BSA.



- a. The thermal flowchart (Figure 4-19) then requires calculation of  $i_{\text{nuc,therm},n}$  per Equation 4-37.  $P_{\text{trans}}$  is 1.0 because icon 36 is Exposed/Dismounted (see Table 4-58). Thus, all 7 personnel in icon 36 receive the thermal challenge.



- b. All three flowcharts then ask whether the personnel become casualties, and the answer is yes.



- c. According to the blast flowchart (Figure 4-18), since icon 36 is dismounted (not in a vehicle or shelter), Equation 4-36 must be used to determine if the individuals are KIA. The blast challenge is 298.69 kPa, and the *threshold* for KIA is:

$$I_{\text{death,blast}} = -56.89 \cdot \ln(10) + 427.47 = 296.48 \text{ kPa}, \quad (4-2)$$



thus, icon 36 is KIA.

[7, KIA, 1.0, 0, 1]

6. Next consider icon 81.



- a. The dose and insult ranges for icon 81 are  $< 1.25$  Gy,  $< 50$  kPa, and  $1 - < 10\%$  BSA. Thus, the personnel in icon 81 are only injured as a result of **thermal** challenge, and only the thermal flowchart need be consulted.



- b. With the insult range determined, the next step in Figure 4-19 is to calculate  $i_{\text{nuc,therm},n}$ . Icon 81's vehicle type is "Armored Personnel Carrier – Open," which has a thermal transmission probability of 1 for the "unwarned" status being modeled in this example. Thus, the entire icon (2 people) receives the thermal challenge.

**D**

- c. Next, Figure 4-19 says to use Figure 1-1 and Table 4-61 to determine whether the icon becomes WIA; it does.

**E F**

- d. Next, Figure 4-19 says to determine whether the icon's Injury Severity Level is 4 for longer than  $T_{\text{death-CN-SL4}}$ ; as the icon's Injury Severity Level will never be 4, it is not. Thus, the icon is reported as WIA/WIA(1).

**[2, WIA or WIA(R0, B0, T1), 1.0, 0, 1]**

**G H**

- e. As  $\text{Flag}_{\text{MT}} = \text{Yes}$ , the next step is to report as indicated by Table 4-62, which indicates RTD on Day 15.

**[2, WIA or WIA(R0, B0, T1), 0, 1.0, 15] ; [2, RTD, 1.0, 0, 15]**

7. Next, consider icon 23.

**B B B**

- a. The dose and insult ranges for icon 23 are  $4.5 \text{ --} < 8.3 \text{ Gy}$ ,  $< 50 \text{ kPa}$ , and  $1 \text{ --} < 10\% \text{ BSA}$ . Thus, the personnel in icon 23 have radiation and thermal injuries.

**C**

- b. With the dose and insult range determined, the next step in Figure 4-19 is to calculate  $i_{\text{nucl,therm},n}$ . Icon 23 is dismantled, so the entire icon (7 people) is thermally challenged.

**C D**

- c. The next step in both flowcharts is to determine whether the icon becomes WIA, using Figure 1-1, Table 4-53, and Table 4-61. Both injuries cause the icon to become WIA.

**E D F**

- d. As the thermal Injury Severity Level is never 4, the icon will not be KIA (Figure 4-19), and both charts indicate that the icon shall be reported as WIA. The icon's Day 1 radiation Injury Severity Level is 3 and its Day 1 thermal Injury Severity Level is 1.

**[7, WIA or WIA(R3, B0, T1), 1.0, 0, 1]**

**E F G H**

- e. As  $\text{Flag}_{\text{MT}} = \text{Yes}$ , the next step is to report as indicated by Table 4-54 and Table 4-62, which indicate CONV on Day 30 (radiation) and RTD on Day 15 (thermal). The icon cannot be RTD on Day 15 because it still has a radiation injury, and on Day 30 it will be reported as CONV(R), not CONV(R, T),

because it will be convalescing only from the radiation injury, not from the thermal injury.

**[7, WIA(R3, B0, T1), 0, 1.0, 30]**  
**[7, CONV(R), 1.0, 0, 30]**

8. Next consider icon 119.



- a. The dose and insult ranges for icon 119 are  $\geq 8.3$  Gy,  $50 \text{ --} < 140$  kPa, and  $\geq 30\%$  BSA. Thus, the personnel in icon 119 have all three types of injury.



- b. With the dose and insult range determined, the next step in Figure 4-19 is to calculate  $i_{\text{nucl,therm},n}$ . Icon 119 is in a Wood Frame Building and is unwarned, so the thermal transmission probability is 0.25 (Table 4-58). Thus, 0.25 people are thermally challenged and 0.75 people are not (Equation 4-37).



- c. All three flowcharts then ask whether the personnel become casualties, and the answer is yes for all three challenge types.



- d. Since the icon is inside a shelter, and neither the blast nor thermal Injury Severity Level is 4 before  $T_{\text{MTF}}$ , the next step is to report the icon as WIA.

**[0.25, WIA(R3, B2, T3), 1.0, 0, 1] ; [0.75, WIA(R3, B2, T0), 1.0, 0, 1]**



- e. The next step is to report as indicated by the three medical treatment outcome reporting tables. The blast table (Table 4-57) indicates RTD on Day 9, the thermal table (Table 4-62) indicates 30% DOW on Day 9 and 70% CONV on Day 44,<sup>98</sup> and the radiation table (Table 4-54) indicates 100% DOW at a time calculated according to Equation 4-35. The notes explaining Equation 4-35 explain that for radiation dose greater than 100 Gy, the time to death is 1 day. Following the reporting rules in Table 1-4, this is reported on Day 2. Of the three injury types, radiation takes precedence.

**[0.25, WIA(R3, B2, T3), 0, 1.0, 2] ; [0.75, WIA(R3, B2, T0), 0, 1.0, 2]**  
**[1, DOW, 1.0, 0, 2]**

9. Finally, consider icon 153.



<sup>98</sup> Note: the Effective Challenge is  $< 45\%$  BSA.

- a. The dose and insult ranges for icon 153 are  $\geq 8.3$  Gy,  $< 50$  kPa, and  $\geq 30\%$  BSA. Thus, personnel in icon 153 have radiation and thermal injuries.



- b. With the dose and insult range determined, the next step in Figure 4-19 is to calculate  $i_{\text{nucl,therm},n}$ . Icon 153 is in a Tent and is unwarned, so the thermal transmission probability is 0.25 (Table 4-58). Thus, 1.5 people are thermally challenged and 4.5 people are not (Equation 4-37).



- c. All three flowcharts then ask whether the personnel become casualties, and the answer is yes for all radiation and thermal.



- d. As the thermal Injury Severity Level is not 4 before  $T_{\text{MTF}}$ , the next step is to report the icon as WIA.

**[1.5, WIA(R3, B0, T3), 1.0, 0, 1] ; [4.5, WIA(R3, B0, T0), 1.0, 0, 1]**



- e. The next step is to report as indicated by the two medical treatment outcome reporting tables. The thermal table (Table 4-62) indicates 30% DOW on Day 9 and 70% CONV on Day 44,<sup>99</sup> and the radiation table (Table 4-54) indicates 100% DOW at a time calculated according to Equation 4-35.

$$T_{\text{death,wb,153}} = 429 \cdot (70.32)^{-1.3} = 1.7 \text{ days} \quad (4-35)$$

Thus, the radiation table indicates that casualties DOW during Day 2. Following the reporting rules in Table 1-4, this is reported on Day 3. Radiation takes precedence over thermal in this case because it gives the earliest reported time to DOW.

**[1.5, WIA(R3, B0, T3), 0, 1.0, 3] ; [4.5, WIA(R3, B0, T0), 0, 1.0, 3]  
[6, DOW, 1.0, 0, 3]**

10. Once the process illustrated above for the 6 selected icons is completed for all 155 icons, the output tables can be assembled.

#### A.6.4. REPORT

1. Using the casualty reporting information from Section A.6.3 to generate the final output tables is not practically different from the process illustrated in the previous examples, so it will not be illustrated again here.

<sup>99</sup> Note: the Effective Challenge is  $< 45\%$  BSA.

**Table A-25: Estimated Daily Number of New Nuclear Casualties\***

Casualty Description	Day 1	Day 2	Day 3	Day 4	Day 5	Day 6	Day 7	Days 8-14	Days 15-30	Days 31+
New KIA (N)	21	0	0	0	0	0	0	0	0	0
New DOW (CRN)	0	266	47	27	17	12	2	67	75	7
Sum of New Fatalities	21	266	47	27	17	12	2	67	75	7
New WIA (Nuclear)	725	0	0	0	0	0	0	0	0	0
New CONV (Nuclear)	0	0	0	0	0	0	0	0	47	56
New RTD	0	0	0	0	0	0	0	0	94	0

\* Estimate is based on Casualty Criterion WIA(1+), a PAR of 816, and Flag<sub>MT</sub> = Yes w/o G-CSF.

**Table A-26: Estimated Personnel Status for Nuclear Casualties\***

Casualty Description	Day 1	Day 2	Day 3	Day 4	Day 5	Day 6	Day 7	Days 8-14	Days 15-30	Days 31+
Fatalities										
KIA—N	21	21	21	21	21	21	21	21	21	21
DOW—CRN	0	266	313	340	357	369	371	438	513	520
Sum of Fatalities	21	287	334	361	378	390	392	459	534	541
WIA										
R0, B0, T1	94	140	140	140	140	140	140	140	0	0
R1, B0, T0	9	0	0	0	0	0	0	0	0	0
R1, B0, T1	47	0	0	0	0	0	0	0	0	0
R2, B0, T0	7	0	0	0	0	0	0	0	14	0
R2, B0, T1	7	14	14	14	14	14	14	14	0	0
R3, B0, T0	129	0	0	0	0	0	0	0	48	0
R3, B0, T1	57	176	145	137	128	118	116	80	0	0
R3, B0, T2	57	57	57	57	57	57	57	42	0	0
R3, B0, T3	78	55	47	28	20	18	18	2	2	0
R3, B2, T0	64	0	0	0	0	0	0	0	0	0
R3, B2, T1	0	8	0	0	0	0	0	0	0	0
R3, B2, T3	99	0	0	0	0	0	0	0	0	0
R3, B3, T0	51	0	0	0	0	0	0	0	0	0
R3, B3, T3	27	0	0	0	0	0	0	0	0	0
Sum of WIA	726	450	403	376	359	347	345	278	64	0
CONV										
CONV (R)	0	9	9	9	9	9	9	9	55	110
CONV (R, T)	0	0	0	0	0	0	0	0	0	1
Sum of CONV	0	9	9	9	9	9	9	9	55	111
RTD										
RTD	0	0	0	0	0	0	0	0	94	94



\* Estimate is based on Casualty Criterion WIA(1+), a PAR of 816, and Flag<sub>MT</sub> = Yes w/o G-CSF.

## A.7. NON-CONTAGIOUS BIOLOGICAL AGENT: *B. ANTHRACIS*

1. The following excerpt from Table 1-5 shows which sections of AMedP-7.5 explain how to complete the five major steps for an anthrax casualty estimate.

Agent, Effect, or Disease	Five Steps			
	INPUT	CHALLENGE	RESPONSE/STATUS	REPORT
Anthrax	Ch. 2	Ch. 3	Sections 5.2.1 and 5.1.4	Ch. 6

2. In order to more easily follow along with the example, it is recommended that the reader print and have available for reference the following figures and tables: Figure 1-1, Figure 1-3, the annotated version of Figure 5-3 located on the next page, Table 5-4, Table 5-6 to Table 5-8, and Table A-1.

3. The red octagons containing a single letter in the annotated version of Figure 5-3 are user aids to help link the text later in the anthrax example to the various parts of the flowchart. Specifically, the red octagons are used to mark the *beginning* of the text discussion related to the linked flowchart element. For example, the  on the first line of Section A.7.2 indicates that the discussion of the calculation of the Effective CBRN Challenge ( $X_{anth,n}^{eff}$ ) begins there;  is linked to the calculation of  $X_{anth,n}^{eff}$  because of its placement in the annotated version of Figure 5-3.

4. As noted in Table A-2, the anthrax example will illustrate the process for a casualty criterion of WIA(1+) and Flag<sub>MT</sub> = Yes. Further, this example will be different from the previous examples in that the forces will be modeled as initially not wearing their masks, but then donning their masks partway through the scenario. For simplicity, it is assumed that all personnel don masks at the same time: 15 minutes into the challenge.

### A.7.1. INPUT

1. Two INPUTs not given in Section A.2 are needed: the CBRN Challenge per icon over time, and the vaccination status of each icon. Although it is unlikely in a real scenario, this example is based on the assumption of no vaccination ( $\rho_n = 0$  for all  $n$ ). If vaccination was included in the scenario, very few casualties would occur. The CBRN Challenge step is not associated with a red octagon because it occurs in the flowchart of Figure 1-3, which is “upstream” of Figure 5-3. Finally, as stated in Section 2.1.2, the CBRN Challenge must be generated independently of AMedP-7.5, using national tools.

2. The simulated attack comprised a person with a backpack sprayer containing 14 kg of *B. anthracis*, standing southwest of the airfield base. The backpack sprayer released *B. anthracis* (with an active fraction of 0.6) at a rate of 0.279972 kg/min over the course of 50 minutes, at a height of 2 meters. The simulated attack occurred at 2000 hours on cultivated terrain. Meteorological conditions were no cloud cover, wind at an average speed of about 2 m/s from the southwest toward the northeast, and an

average temperature of 20.7 °C. Figure A-6 is a qualitative depiction of the CBRN Challenge (cumulative) at the end of the simulation. Each filled red circle represents an icon, and the *B. anthracis* plume is depicted with colors indicating different amounts of CBRN Challenge (purple is low, red is high).



\* Casualty information (Pop<sub>cohort</sub>, CAT, table number) is passed to Equations 5-5 through 5-8.  
† Personnel status information (Pop<sub>cohort</sub>, CAT, table number) is passed to Equation 5-7 and 5-8.

Figure 5-3 Annotated for Illustrative Example

3. To generate the quantitative input needed for AMedP-7.5, the CBRN Challenge per icon was extracted from HPAC in one-minute intervals. The extracted data for 7 selected icons are shown in Table A-27. Data are shown only for the three time points needed to complete the calculation of Effective CBRN Challenge. The table is in the CHALLENGE section (Section A.7.2) because it also includes all other information used to calculate Effective CBRN Challenge, and the final calculated values for each selected icon.



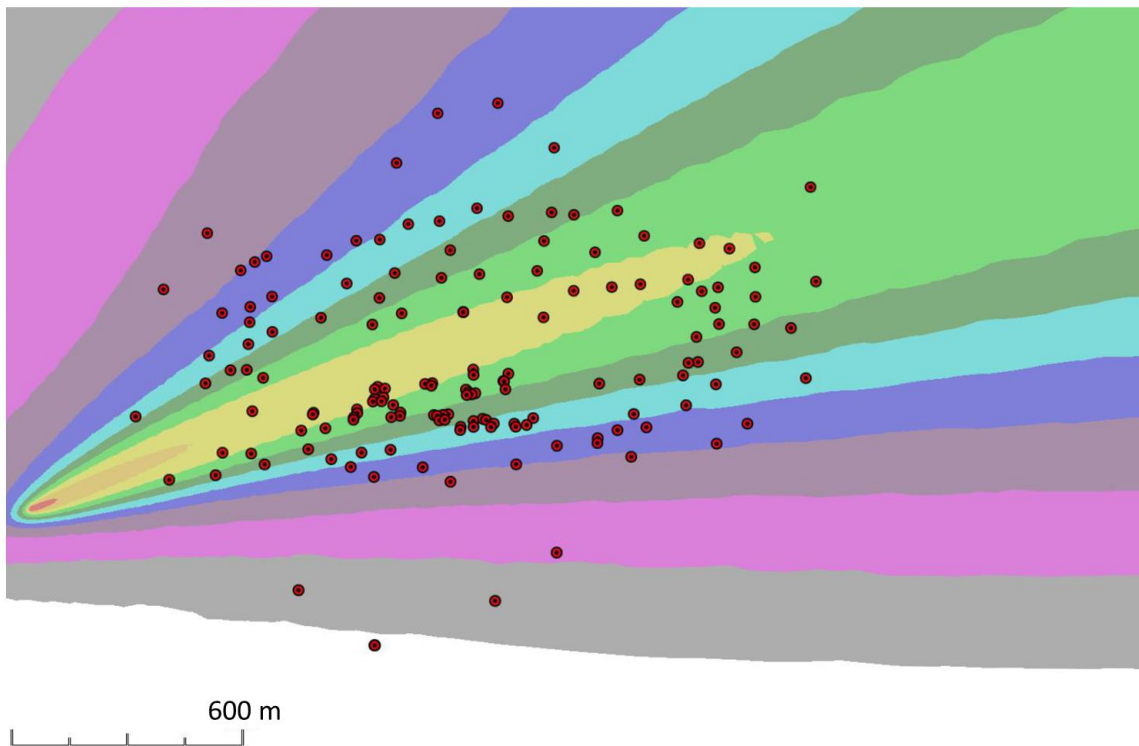

Figure A-6: *B. anthracis* (Anthrax) Attack on Task Force

### A.7.2. CHALLENGE

A

1. As the IPE attribute for several of the icons does change over time, the sum in Equation 3-1 must have two terms. Thus, the application of Equation 3-1 for this example is:

$$X_{anth,n}^{eff} = \frac{(X_{anth,n,15} - X_{anth,n,0}) \cdot Z_n}{APF_{anth,t < 15,n}} + \frac{(X_{anth,n,100} - X_{anth,n,15}) \cdot Z_n}{APF_{anth,t \geq 15,n}} \quad (3-1)$$

2. The values of  $X_{anth,n,0}$ ,  $X_{anth,n,15}$ , and  $X_{anth,n,100}$  are in the second through fourth columns of Table A-27. The APF is calculated per 2-2, with  $PF_{IPE,anth,n} = 1$  for  $t < 15$ , and the value indicated in the table for  $t \geq 15$ . Details of the APF calculation are not repeated here because the process was illustrated in the GB example.

3. The value of  $Z_n$  is determined by matching the specified Activity Level in Table A-1 with the corresponding minute volume from Table 2-3.

4. Using the data in Table A-27 and the version of Equation 3-1, the Effective CBRN Challenge per icon may be calculated. Table A-27 contains the results. The results for all 155 icons are not shown, for brevity.



**Table A-27: *B. anthracis* CBRN Challenge Data and Calculation of Effective CBRN Challenge for Selected Icons**

Icon # ( <i>n</i> )	$X_{anth,n,t_k}$ [spores-min/m <sup>3</sup> ] at Time $t_k$ [min]			Minute Volume ( $Z_n$ ) (m <sup>3</sup> /min)	PF <sub>IPE,anth</sub> ( $t_k \geq 15$ min)	PF <sub>V-SH,anth,n</sub> (all times)	$X_{anth,n}^{eff}$ [spores- min/m <sup>3</sup> ]
	0	15	100				
8	0	$2.99 \times 10^4$	$5.66 \times 10^5$	0.03	100,000	1	$4.35 \times 10^2$
63	0	$8.62 \times 10^{-1}$	$5.58 \times 10^2$	0.03	100,000	1	$9.22 \times 10^{-3}$
73	0	$4.13 \times 10^8$	$1.87 \times 10^9$	0.03	100,000	1.054	$1.03 \times 10^7$
94	0	$9.60 \times 10^7$	$3.84 \times 10^8$	0.03	100,000	1.054	$2.46 \times 10^6$
98	0	$1.55 \times 10^7$	$6.09 \times 10^7$	0.03	100,000	1.052	$4.09 \times 10^5$
115	0	$2.47 \times 10^8$	$1.54 \times 10^9$	0.03	1	3000	$1.54 \times 10^4$
116	0	$1.14 \times 10^8$	$7.79 \times 10^8$	0.03	1	3000	$7.79 \times 10^3$

### A.7.3. RESPONSE/STATUS

**B**

1. Figure 5-3 indicates that the next step is to assign each icon to a dose range. This is done simply by comparing the icon's  $X_{anth,n}^{eff}$  to the values in Table 5-4.

**C**

2. Now, with  $X_{anth,n}^{eff}$ ,  $i_n$ , and  $p_n$  available, and each icon assigned to a dose range, the next step is to estimate the populations of the  $E_{DR}$  cohorts, using Equation 5-1. Section 5.2.1.3 also states that Equation 5-1 is applied separately to each dose range.

a. Thus, for example, every icon for which the following inequality is true will be used to calculate the population of  $E_D$ :  $10^4 < X_{anth,n}^{eff} \leq 10^5$ . The example icons in Table A-27 were chosen to have one icon per dose range. Taking icon 115 as an example, the application of Equation 5-1 is:

$$E = (10 \cdot (1 - 0) \cdot p_E(X_{anth,115}^{eff}))$$

b. Table 5-8 indicates that the value of  $p_E(X_{anth,115}^{eff})$  should be calculated using Equation 5-32, which, for icon 115, is implemented via:

$$p_E(X_{anth,115}^{eff}) = \Phi \left( 1 \cdot \log_{10} \left( \frac{1.54 \times 10^4 \text{ spores}}{2.00 \times 10^4 \text{ spores}} \right) \right) = 0.4548$$

c. Plugging  $p_E(X_{anth,115}^{eff})$  back into the equation for  $E$  gives 4.548 individuals in  $E_D$  from icon 115. Expanding these calculations to all icons and all dose ranges gives the populations of all the  $E_{DR}$  (see Table A-28), which are necessary for the remainder of the process diagrammed in Figure 5-3.



3. The casualty criterion is WIA(1+), so the next step is to report the daily number of WIA and WIA(2) to Equations 5-5 and 5-7. Using the  $E_{DR}$  populations from Table A-28, the reporting information passed to the equations is:

[0.111, WIA or WIA(2), Table 5-9A] ; [3.442, WIA or WIA(2), Table 5-9B]  
 [23.468, WIA or WIA(2), Table 5-9C] ; [79.822, WIA or WIA(2), Table 5-9D]  
 [129.139, WIA or WIA(2), Table 5-9E] ; [211.788, WIA or WIA(2), Table 5-9F]  
 [69.846, WIA or WIA(2), Table 5-9G]



4. As the value of Flag<sub>MT</sub> is Yes, the next step in Figure 5-3 is to calculate the populations of the  $F_{DR,U}$ ,  $F_{DR,T-2}$ ,  $F_{DR,T-1}$ , and  $S_{DR,T-1}$  cohorts. These calculations will not be shown here; the results are in given Table A-28. As stated in Table A-2, the value of  $d_{\text{trt-anth}}$  used to calculate the populations was 7 days.

**Table A-28: Populations of Anthrax Cohorts**

Dose Range	$E_{DR}$	$F_{DR,U}$	$F_{DR,T-2}$	$F_{DR,T-1}$	$S_{DR,T-1}$
A	0.111	0.009	0.004	0.011	0.087
B	3.442	0.363	0.168	0.335	2.576
C	23.468	3.818	1.692	2.232	15.726
D	79.822	23.579	8.637	6.883	40.723
E	129.139	69.980	15.471	7.944	35.744
F	211.788	161.319	16.181	7.021	27.267
G	69.846	56.191	4.484	2.049	7.122



5. With the cohort populations calculated, the next step in Figure 5-3 is to report the daily number of casualties becoming WIA(4), using Table 5-10 and Table 5-12. The reporting information passed to Equation 5-7 is:

[0.009, WIA(4), Table 5-10A] ; [0.363, WIA(4), Table 5-10B]  
 [3.818, WIA(4), Table 5-10C] ; [23.579, WIA(4), Table 5-10D]  
 [69.980, WIA(4), Table 5-10E] ; [161.319, WIA(4), Table 5-10F]  
 [56.191, WIA(4), Table 5-10G]  
 [0.004, WIA(4), Table 5-10A] ; [0.168, WIA(4), Table 5-10B]  
 [1.692, WIA(4), Table 5-10C] ; [8.637, WIA(4), Table 5-10D]  
 [15.471, WIA(4), Table 5-10E] ; [16.181, WIA(4), Table 5-10F]  
 [4.484, WIA(4), Table 5-10G]  
 [0.011, WIA(4), Table 5-12A] ; [0.335, WIA(4), Table 5-12B]  
 [2.232, WIA(4), Table 5-12C] ; [6.883, WIA(4), Table 5-12D]  
 [7.944, WIA(4), Table 5-12E] ; [7.021, WIA(4), Table 5-12F]  
 [2.049, WIA(4), Table 5-12G]  
 [0.087, WIA(4), Table 5-12A] ; [2.576, WIA(4), Table 5-12B]  
 [15.726, WIA(4), Table 5-12C] ; [40.723, WIA(4), Table 5-12D]  
 [35.744, WIA(4), Table 5-12E] ; [27.267, WIA(4), Table 5-12F]  
 [7.122, WIA(4), Table 5-12G]

I

6. Following one flowchart branch, the next step is to report the daily number of DOW, using Table 5-11, Table 5-13, and Table 5-16. The reporting information passed to Equations 5-6 to 5-8 is:

[0.009, DOW, Table 5-11A] ; [0.363, DOW, Table 5-11B]  
 [3.818, DOW, Table 5-11c] ; [23.579, DOW, Table 5-11D]  
 [69.980, DOW, Table 5-11E] ; [160.319, DOW, Table 5-11F]  
 [56.191, DOW, Table 5-11G]  
 [0.004, DOW, Table 5-16A] ; [0.168, DOW, Table 5-16B]  
 [1.692, DOW, Table 5-16c] ; [8.637, DOW, Table 5-16D]  
 [15.471, DOW, Table 5-16E] ; [16.181, DOW, Table 5-16F]  
 [4.484, DOW, Table 5-16G]  
 [0.011, DOW, Table 5-13A] ; [0.335, DOW, Table 5-13B]  
 [2.232, DOW, Table 5-13c] ; [6.883, DOW, Table 5-13D]  
 [7.944, DOW, Table 5-13E] ; [7.021, DOW, Table 5-13F]  
 [2.049, DOW, Table 5-13G]

J

K

L

7. Following the other flowchart branch, the daily number becoming WIA(3) must be reported to Equation 5-7, then the daily number of CONV must be reported to Equations 5-6 to 5-8, then the daily number of RTD must be reported to Equations 5-6 to 5-8. For brevity, the reporting information is not stated here; it follows the pattern established above.

#### A.7.4. REPORT

1. Section A.7.3 stated some of the information that would be reported to Equations 5-5 to 5-8. This section will give a few examples of how that information is used to populate the output tables, and will show the completed output tables.

2. As an example of the use of Equation 5-5, consider the application to determine the number of new WIA on Day 2. Note that the “relevant cohorts” in Equation 5-5 are each of the seven  $E_{DR}$ , and the values pulled from the PDT (Table 5-9) depend upon the dose range, as indicated by the reporting information listed under paragraph 2 of Section A.7.3.

$$\begin{aligned} \text{New}_{WIA}(2) = & 0.111 \cdot 0.0185 + 3.442 \cdot 0.0216 + 23.468 \cdot 0.0326 + 79.822 \cdot 0.0793 \\ & + 129.139 \cdot 0.3779 + 211.788 \cdot 0.2583 + 69.846 \cdot 0.0002 = 110.69 \approx 111 \end{aligned} \quad (5-5)$$

The rate table (Table A-29) reports 111 casualties as new WIA on Day 2.

3. As an example of the use of Equation 5-6, consider the application to determine the number of new DOW on Day 7. The relevant cohorts are all F cohorts: the seven  $F_{DR,U}$ , the seven  $F_{DR,T-2}$ , and the seven  $F_{DR,T-1}$ . The reporting information is listed under paragraph 5 of Section A.7.3. Note that the values pulled from the PDTs are

from the Day 6 row of each PDT.

$$\begin{aligned}
 \text{New}_{\text{DOW}}(7) = & 0.009 \cdot 0.0244 + 0.363 \cdot 0.0325 + 3.818 \cdot 0.0513 + 23.579 \cdot 0.0985 \\
 & + 69.980 \cdot 0.1863 + 161.319 \cdot 0.1851 + 56.191 \cdot 0.1638 + 0.004 \cdot 0.0150 + \\
 & + 0.168 \cdot 0.0197 + 1.692 \cdot 0.0312 + 8.637 \cdot 0.0631 + 15.471 \cdot 0.1416 + \\
 & + 16.181 \cdot 0.1893 + 4.484 \cdot 0.1803 + 0.011 \cdot 0.0028 + 0.335 \cdot 0.0034 + \\
 & + 2.232 \cdot 0.0053 + 6.883 \cdot 0.0120 + 7.944 \cdot 0.0420 + 7.021 \cdot 0.1348 + \\
 & + 2.049 \cdot 0.1618 = 63.002 \approx 63
 \end{aligned} \tag{5-6}$$

The rate table (Table A-29) reports 63 casualties as new DOW on Day 7.

4. As an example of Equation 5-7, consider the application to determine the total number of WIA(4) on Day 5. Each of the seven dose ranges within the  $F_{\text{DR,U}}$ ,  $F_{\text{DR,T-2}}$ ,  $F_{\text{DR,T-1}}$ , and  $S_{\text{DR,T-1}}$  are relevant as both “entering” and “exiting” cohorts. Rather than write out all the numbers, the following is a slightly shorter, and perhaps more instructive, version of Equation 5-7.

$$\begin{aligned}
 \text{Tot}_{\text{WIA}(4)}(5) &= \text{Tot}_{\text{WIA}(4)}(4) + \\
 \sum_{\text{DR}} & \left( F_{\text{DR,U}} \cdot \text{PDT}_{5-10}(5) + F_{\text{DR,T-2}} \cdot \text{PDT}_{5-10}(5) + F_{\text{DR,T-1}} \cdot \text{PDT}_{5-12}(5) + S_{\text{DR,T-1}} \cdot \text{PDT}_{5-12}(5) \right) - \\
 \sum_{\text{DR}} & \left( F_{\text{DR,U}} \cdot \text{PDT}_{5-11}(4) + F_{\text{DR,T-2}} \cdot \text{PDT}_{5-16}(4) + F_{\text{DR,T-1}} \cdot \text{PDT}_{5-13}(4) + S_{\text{DR,T-1}} \cdot \text{PDT}_{5-13}(5) \right)
 \end{aligned} \tag{5-7}$$

5. As an example of Equation 5-8, consider the application to determine the total number of DOW on Day 5. Each of the seven dose ranges within the  $F_{\text{DR,U}}$ ,  $F_{\text{DR,T-2}}$ , and  $F_{\text{DR,T-1}}$  are relevant as “entering,” and there are no “exiting” cohorts.

$$\begin{aligned}
 \text{Tot}_{\text{DOW}}(5) &= \text{Tot}_{\text{DOW}}(4) + \\
 \sum_{\text{DR}} & \left( F_{\text{DR,U}} \cdot \text{PDT}_{5-11}(4) + F_{\text{DR,T-2}} \cdot \text{PDT}_{5-16}(4) + F_{\text{DR,T-1}} \cdot \text{PDT}_{5-13}(4) \right)
 \end{aligned} \tag{5-8}$$

6. To complete all entries in the reporting tables, Equations 5-5 to 5-8 must be applied for every day for which the PDTs contain entries. The remainder of the calculations are not shown here. The results are given in Table A-29 and Table A-30. Note that the tables stop at Day 99+ even though some PDTs extend longer; this is because rounding to whole numbers causes no more change in casualty status to occur after Day 98.

**Table A-29: Estimated Daily Number of New Anthrax Casualties\***

Casualty Description	Day 1	Day 2	Day 3	Day 4	Day 5	Day 6	Day 7	Days 8-14	Days 15-21	Days 22-28	Days 29-35	Days 36-42	Days 43-70	Days 71-77	Days 78-84	Days 85-91	Days 92-98	Days 99+
New DOW (B)	0	0	1	16	45	62	63	55-7	5-0	0	0	0	0	0	0	0	0	0
New WIA (Anthrax)	228	111	81	44	23	13	7	4-0	0	0	0	0	0	0	0	0	0	0
New CONV (Anthrax)	0	0	0	0	0	0	0	0	0-17	17-3	2-0	0	0	0	0	0	0	0
New RTD	0	0	0	0	0	0	0	0	0	0	0	0	0	0-3	7-12	9-1	1-0	0

\* Estimate is based on Casualty Criterion WIA(1+), a PAR of 816, and  $d_{\text{trt-anth}} = 7$  days.

**Table A-30: Estimated Personnel Status for Anthrax Casualties\***

Casualty Description	Day 1	Day 2	Day 3	Day 4	Day 5	Day 6	Day 7	Days 8-14	Days 15-21	Days 22-28	Days 29-35	Days 36-42	Days 43-70	Days 71-77	Days 78-84	Days 85-91	Days 92-98	Days 99+
Fatalities																		
DOW (B)	0	0	1	17	61	123	186	241-373	378-387	388	388	388-389	389	389	389	389	389	389
WIA																		
Anthrax(2)	228	334	379	357	304	243	185	136-14	10-1	1-0	0	0	0	0	0	0	0	0
Anthrax(3)	0	0	0	0	0	3	10	22-107	114-72	56-7	5-1	1-0	0	0	0	0	0	0
Anthrax(4)	0	5	40	89	118	123	114	97-16	11-1	1-0	0	0	0	0	0	0	0	0
Sum of WIA	228	339	419	446	422	370	309	255-137	135-74	58-7	5-1	1-0	0	0	0	0	0	0
CONV																		
CONV (Anthrax)	0	0	0	0	0	0	0	0	0-55	72-122	124-128	129	129	129-126	119-31	22-3	2-0	0
RTD																		
RTD	0	0	0	0	0	0	0	0	0	0	0	0	0	0-3	10-98	107-127	127-129	129

\* Estimate is based on Casualty Criterion WIA(1+), a PAR of 816, and  $d_{\text{trt-anth}} = 7$  days.

**INTENTIONALLY BLANK**

**A.8. CONTAGIOUS BIOLOGICAL AGENT: *V. MAJOR***



1. The following excerpt from Table 1-5 shows which sections of AMedP-7.5 explain how to complete the five major steps for a smallpox (contagious) casualty estimate.

Agent, Effect, or Disease	Five Steps			
	INPUT	CHALLENGE	RESPONSE/STATUS	REPORT
Smallpox (isolation/quarantine)	Ch. 2	Ch. 3	Sections 5.2.9 and 5.1.4	Ch. 6
Smallpox (contagious)	Ch. 2	Ch. 3	Sections 5.2.10 and 5.1.5	Ch. 6

2. In order to more easily follow along with the example, it is recommended that the reader print and have available for reference the following figures and tables:

- a. For isolation/quarantine and contagious: Figure 1-1, Figure 1-3, Table 5-77 to Table 5-79, Table A-1.
- b. For isolation/quarantine only: the annotated version of Figure 5-10 located on the next page.
- c. For contagious only: Figure 5-2, Table 5-3, Table 5-84, and Table 5-86.

3. The red octagons containing a single letter in the annotated version of Figure 5-10 are user aids to help link the text later in the isolation/quarantine smallpox sections to the various parts of the flowchart. Specifically, the red octagons are used to mark the *beginning* of the text discussion related to the linked flowchart element.

For example, the  on the first line of Section A.8.2 indicates that the discussion of the calculation of the Effective CBRN Challenge ( $X_{spox,n}^{eff}$ ) begins there;  is linked to the calculation of  $X_{spox,n}^{eff}$  because of its placement in the annotated version of Figure 5-10.

4. As noted in Table A-2, the smallpox example will illustrate a smallpox casualty estimate for two cases. In one case, the casualty criterion is WIA(1+) and the isolation/quarantine model will be used. In the other case, the casualty criterion is WIA(3+) and the contagious model will be used. In both cases, Flag<sub>MT</sub> = Yes and  $d_{vac-spox}$  = day 12 (to model a scenario in which vaccination occurs in response to personnel becoming ill with smallpox, but it takes some time to ship the vaccines to the theatre of operations). Further, this example will be like the anthrax example in that the forces will be modeled as initially not wearing their masks, but then donning their masks partway through the scenario. For simplicity, it is assumed that all personnel don masks at the same time: 15 minutes into the challenge.

5. The INPUT and CHALLENGE sections are the same for the

isolation/quarantine and contagious models, so they will not be repeated. However, the RESPONSE/STATUS and REPORT sections are separate for the isolation/quarantine (Sections A.8.3 and A.8.4) and contagious (Sections A.8.5 and A.8.6) models.

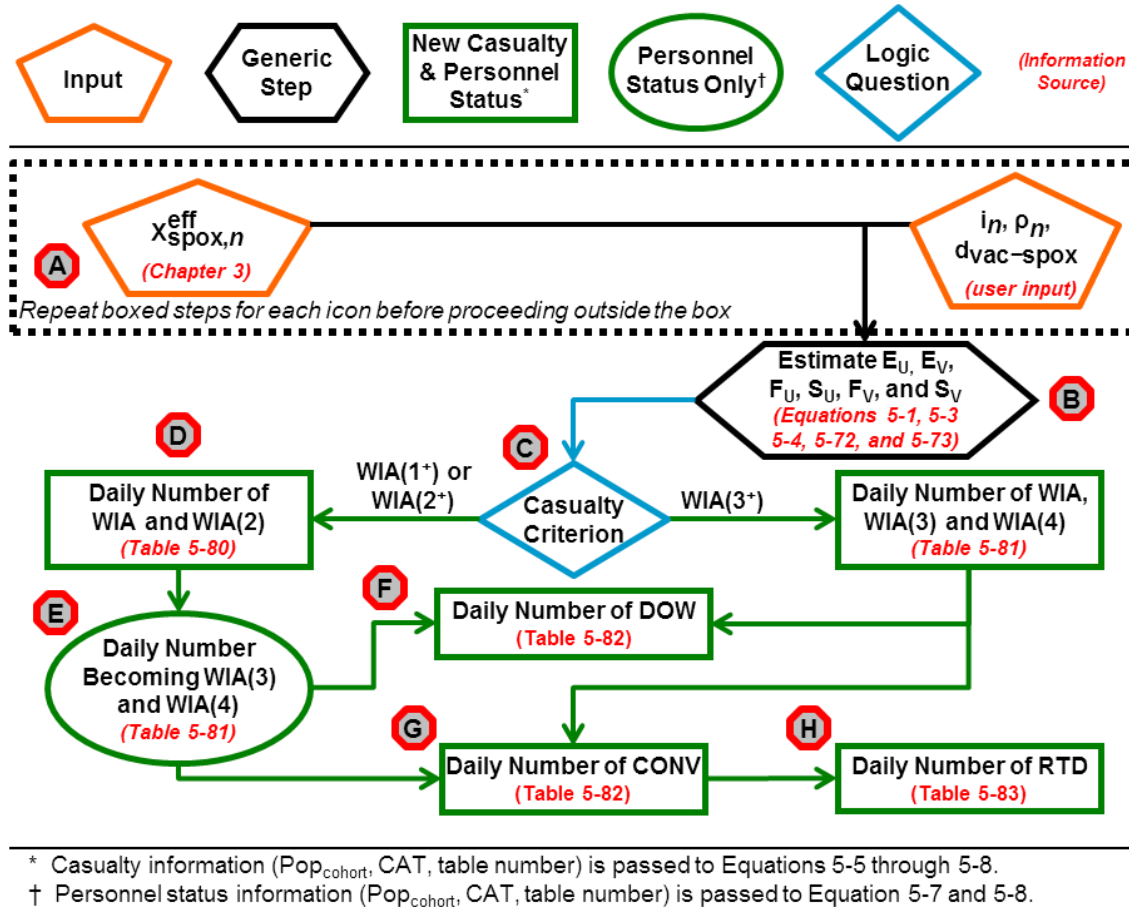

Figure 5-10 Annotated for Illustrative Example

### A.8.1. INPUT

1. The only INPUT needed that was not given in Section A.2 is the CBRN Challenge per icon over time. In addition to the value of  $d_{vac-spox}$ , it is also necessary to know that all icons are assumed to have the same vaccination status, that is, they are unvaccinated before the attack, and all are vaccinated on day 12. If icons were instead vaccinated before the challenge, very few casualties would occur. The CBRN Challenge step is not associated with a red octagon on the isolation/quarantine flowchart because it occurs in the flowchart of Figure 1-3, which is “upstream” of Figure 5-10. Finally, as stated in Section 2.1.2, the CBRN Challenge must be generated independently of AMedP-7.5, using national tools.

2. The simulated attack comprised a person with a backpack sprayer containing 14 kg of *V. major*, standing southwest of the airfield base. The backpack sprayer



released *V. major* (with an active fraction of 0.6) at a rate of 0.279972 kg/min over the course of 50 minutes, at a height of 2 meters. The simulated attack occurred at 2000 hours on cultivated terrain. Meteorological conditions were no cloud cover, wind at an average speed of about 2 m/s from the southwest toward the northeast, and an average temperature of 20.7 °C. Figure A-7 is a qualitative depiction of the CBRN Challenge (cumulative) at the end of the simulation. Each filled red circle represents an icon in the task force, and the *V. major* plume is depicted with colors indicating different amounts of CBRN Challenge (purple is low, red is high).

3. To generate the quantitative input needed for AMedP-7.5, the CBRN Challenge per icon was extracted from HPAC in one-minute intervals.

### A.8.2. CHALLENGE

**A**

The other illustrative examples have demonstrated calculation of the Effective CBRN Challenge in sufficient detail that another example is not warranted here. The value of  $X_{\text{spox},n}^{\text{eff}}$  per icon was estimated consistent with the method demonstrated in anthrax example, including the delayed masking at 15 minutes into the challenge.

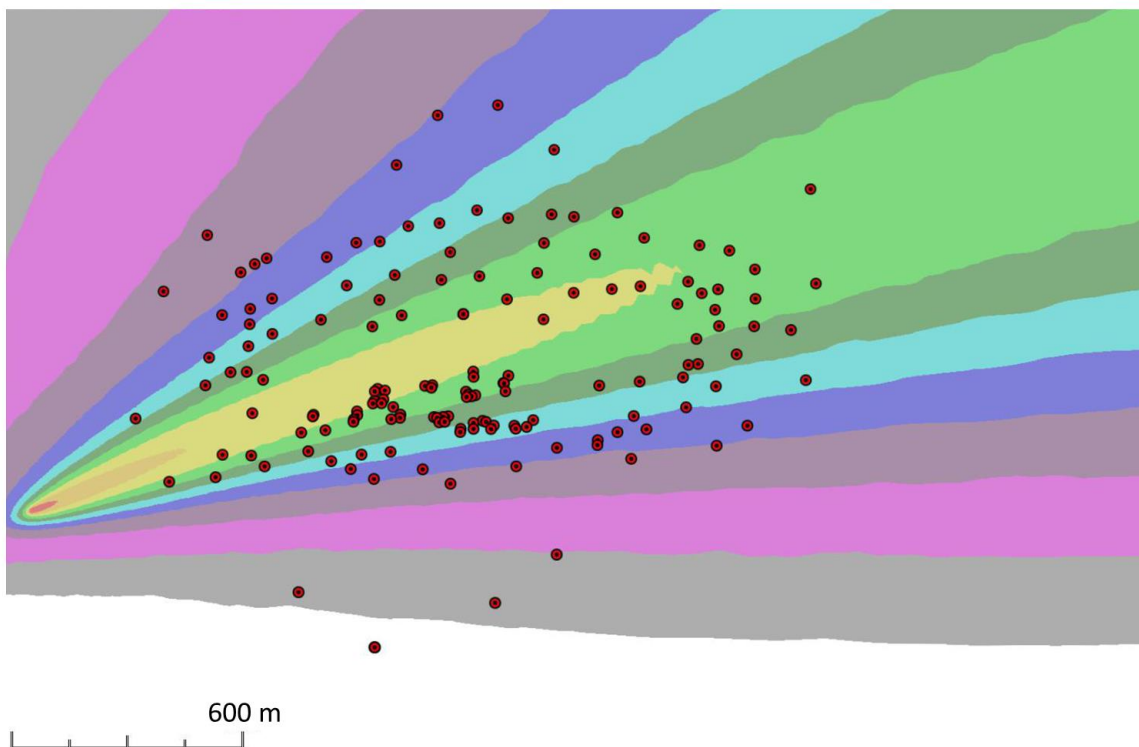

Figure A-7: *V. major* (Smallpox) Attack on Task Force

### A.8.3. RESPONSE/STATUS—Isolation/Quarantine Model

**B**

1. According to Figure 5-10, with  $X_{\text{spox},n}^{\text{eff}}$ ,  $i_n$ , and  $d_{\text{vac-spox}}$  available, the next step is to estimate the populations of the cohorts using Equations 5-3, 5-4, 5-72, and 5-73.
2. First, the populations of  $E_U$  and  $E_V$  are calculated using Equations 5-72 and 5-73. Determining  $p_E(X_{\text{spox},n}^{\text{eff}})$  is relatively simple due to the threshold infectivity model indicated in Table 5-79: if  $X_{\text{spox},n}^{\text{eff}} \geq 10$  PFU, the value is 1, and if not, the value is 0. Because applying the equations is simple and the application of similar equations has been demonstrated in Section A.7, an example for a single icon will not be shown. Rather, Table A-31 shows the final result.
3. Once the populations of the E cohorts have been determined, applying Equations 5-3 and 5-4 is also straightforward. Since vaccination in this example is post-exposure, Table 5-79 indicates that the CFR to be applied to  $E_U$  is 30% or 0.3, while the CFR for the  $E_V$  cohort is 20% or 0.2.

**Table A-31: Populations of Smallpox Cohorts**

Cohort	Population
$E_U$	224.190
$E_V$	336.934
$F_U$	67.257
$F_V$	67.387
$S_U$	156.933
$S_V$	269.547

**C** **D**

4. The casualty criterion is  $WIA(1^+)$ , so the next step in Figure 5-10 is to report the daily number of  $WIA$  and  $WIA(2)$  to Equations 5-5 and 5-7. The reporting information passed to the equations is:

**[224.190, WIA or WIA(2), Table 5-80] ; [336.934, WIA or WIA(2), Table 5-80]**

**E**

5. The next step in Figure 5-10 is to report the daily number of  $WIA(3)$  and  $WIA(4)$  to Equation 5-7. The reporting information passed to the equation is:

**[156.933, WIA(3), Table 5-81] ; [269.547, WIA(3), Table 5-81]  
[67.257, WIA(4), Table 5-81] ; [67.387, WIA(4), Table 5-81]**

**F**

6. Following one path in Figure 5-10, the next step is to report the daily number of  $DOW$  to Equations 5-5 and 5-7. The reporting information is:

**[67.257, DOW, Table 5-82] ; [67.387, DOW, Table 5-82]**

**G** **H**

7. Following the other path in Figure 5-10, the next steps are to report the daily number of  $CONV$  to Equation 5-7 and then the daily number of  $RTD$  to Equations 5-5 and 5-7. The reporting information is:

[156.933, CONV, Table 5-82] ; [269.547, CONV, Table 5-82]  
[156.933, RTD, Table 5-83] ; [269.547, RTD, Table 5-83]

#### A.8.4. REPORT–Isolation/Quarantine Model

1. Section A.8.3 stated some of the information that would be reported to Equations 5-5 to 5-8. This section will give a few examples of how that information is used to populate the output tables, and will show the completed output tables.

2. As an example of the use of Equation 5-5, consider the application to determine the number of new WIA on Day 11:

$$\text{New}_{\text{WIA}}(11) = 224.190 \cdot 0.2066 + 336.934 \cdot 0.2066 = 115.928 \approx 116 \quad (5-5)$$

The rate table (Table A-32) reports 116 casualties as new WIA on Day 11.

3. As an example of the use of Equation 5-6, consider the application to determine the number of new RTD on Day 32.

$$\begin{aligned} \text{New}_{\text{RTD}}(32) &= \text{Pop}_{\text{S}_U} \cdot \text{PDT}_{5-83}(31) + \text{Pop}_{\text{S}_V} \cdot \text{PDT}_{5-83}(31) = \\ &156.933 \cdot 0.0866 + 269.547 \cdot 0.0866 = 36.93 \approx 37 \end{aligned} \quad (5-6)$$

The rate table (Table A-32) reports 37 casualties as new RTD on Day 32.

4. As an example of Equation 5-7, consider the application to determine the total number of WIA(3) on Day 14.

$$\begin{aligned} \text{Tot}_{\text{WIA}(3)}(14) &= \text{Tot}_{\text{WIA}(3)}(13) + \left( \text{Pop}_{\text{S}_U} \cdot \text{PDT}_{5-81}(14) + \text{Pop}_{\text{S}_V} \cdot \text{PDT}_{5-81}(14) \right) \\ &\quad - \left( \text{Pop}_{\text{S}_U} \cdot \text{PDT}_{5-82}(14) + \text{Pop}_{\text{S}_V} \cdot \text{PDT}_{5-82}(14) \right) = \\ &94 + (156.933 \cdot 0.1864 + 269.547 \cdot 0.1864) - (156.933 \cdot 0 + 269.547 \cdot 0) = 173.577 \approx 174 \end{aligned} \quad (5-7)$$

The personnel status table (Table A-33) reports 174 total casualties as WIA(3) on Day 14.

5. As an example of Equation 5-8, consider the application to determine the total number of DOW on Day 28.

$$\begin{aligned} \text{Tot}_{\text{DOW}}(28) &= \text{Tot}_{\text{DOW}}(27) + \left( \text{Pop}_{\text{F}_U} \cdot \text{PDT}_{5-82}(27) + \text{Pop}_{\text{F}_V} \cdot \text{PDT}_{5-82}(27) \right) \\ &= 27 + (67.257 \cdot 0.1135 + 67.387 \cdot 0.1135) = 42.28 \approx 42 \end{aligned} \quad (5-8)$$

The personnel status table (Table A-33) reports 42 total casualties as DOW on Day 28.

6. To complete all entries in the reporting tables, Equations 5-5 to 5-8 must be applied for every day for which the PDTs contain entries. The remainder of the calculations is not shown here. The results are given in Table A-32 and

Table A-33. Note that the tables stop at Day 47+ even though some PDTs extend longer; this is because rounding to whole numbers causes no more change in casualty status to occur after Day 46.

**Table A-32: Estimated Daily Number of New Smallpox Casualties\***

Casualty Description	Day ≤7	Day 8	Day 9	Day 10	Day 11	Day 12	Day 13	Day 14	Days 15-17	Days 18-21	Days 22-24	Days 25-28	Days 29-31	Days 32-35	Days 36-38	Days 39-42	Days 43-46	Days ≥47
New DOW (B)	0	0	0	0	0	0	0	0	0	0	0-2	4-15	18-16	13-5	3-1	0	0	0
New WIA (Smallpox)	0	5	27	73	116	125	99	62	32-6	2-0	0	0	0	0	0	0	0	0
New CONV (Smallpox)	0	0	0	0	0	0	0	0	0	0-1	2-13	24-55	56-42	32-9	5-1	1-0	0	0
New RTD	0	0	0	0	0	0	0	0	0	0	0	0-2	6-24	37-56	51-32	22-5	3-0	0

\* Estimate is based on Casualty Criterion WIA(1+), a PAR of 816, and  $d_{vac-spox} = 12$  days.

**Table A-33: Estimated Personnel Status for Smallpox Casualties\***

Casualty Description	Day ≤7	Day 8	Day 9	Day 10	Day 11	Day 12	Day 13	Day 14	Days 15-17	Days 18-21	Days 22-24	Days 25-28	Days 29-31	Days 32-35	Days 36-38	Days 39-42	Days 43-46	Days ≥47
Fatalities																		
DOW (B)	0	0	0	0	0	0	0	0	0	0	0-3	7-42	60-94	107-129	132-135	135	135	135
WIA																		
Smallpox (2)	0	6	33	103	208	296	321	278	200-66	31-2	1-0	0	0	0	0	0	0	0
Smallpox (3)	0	0	0	2	10	38	94	174	257-374	402-424	423-404	380-239	182-89	57-11	6-1	1-0	0	0
Smallpox (4)	0	0	0	1	3	12	30	55	81-118	127-134	134-127	120-75	58-28	18-3	2-0	0	0	0
Sum of WIA	0	6	33	106	221	346	445	506	538-531	560	558-531	500-314	240-117	75-14	8-1	1-0	0	0
CONV																		
CONV (Smallpox)	0	0	0	0	0	0	0	0	0	0-1	3-23	47-178	221-254	238-120	83-33	19-3	1-0	0
RTD																		
RTD	0	0	0	0	0	0	0	0	0	0	0	0-3	9-46	83-242	293-367	389-418	421-423	423

\* Estimate is based on Casualty Criterion WIA(1+), a PAR of 816, and  $d_{vac-spox} = 12$  days.

**INTENTIONALLY BLANK**

### A.8.5. RESPONSE/STATUS—Contagious Model

1. The first step of applying the SEIRP model is to calculate the populations of the P, E<sub>1</sub>, and S cohorts on day 0. This is done using Equations 5-9 to 5-11, the implementations of which are not demonstrated because they are simple; the results are P(0) = 816, E<sub>1</sub>(0) = 568, and S(0) = 248.

2. The remainder of the model is simple in concept: once per simulated day, execute Equations 5-12 to 5-31. As  $\mu_{E1} = 7$  days, no changes will occur for the first 7 days; the populations of the P, E<sub>1</sub>, and S cohorts will remain as stated in the previous paragraph.

3. Recall that because  $d_{\text{vac-spox}} = d_{\text{p-on}} = \text{day 12}$ ,  $v_{\text{on}}(12) = 1$ , and  $v_{\text{on}}(d)$  for any other day = 0. As the prophylaxis is by vaccine, not drugs,  $v_{\text{off}}(d) = 0$  for all days. Because  $d_{\text{vac-spox}} = \text{day 12}$ ,  $\rho_E(d_{\text{p-on}}) = 0.02$ , per Table 5-78.

4. On Day 7, all individuals are still incubating, so the I and R cohorts still have zero population, and the S cohort still has 615 individuals. For the E cohorts:

$$E_1(7) = 0 \quad 5-16$$

$$E_2(7) = E_1(6) \cdot \left(1 - \rho_E(d_{\text{p-on}}) \cdot v_{\text{on}}(6)\right) = 568 \cdot (1 - 0.02 \cdot 0) = 568 \quad 5-17$$

5. As  $E_1(7) = 0$ ,  $E_1$  will remain at 0 until contagious spread begins to occur. The first day on which  $\beta(d) > 0$  is Day 9, so  $E_1(8) = E_1(9) = 0$ .  $E_1(8)$  being zero makes calculating  $E_2(8)$  simpler because the second term in Equation 5-19 is zero:

$$E_2(8) = E_2(7) \cdot \left(1 - \rho_E(d_{\text{p-on}}) \cdot v_{\text{on}}(7)\right) \cdot \left(1 - \frac{1}{\mu_{E2}}\right) + 0 = 568 \cdot (1 - 0.02 \cdot 0) \cdot \left(1 - \frac{1}{4.6}\right) = 444.5 \quad 5-19$$

6. On Day 8, the first symptoms appear (people enter I<sub>1</sub>). Since  $MT_{I1} = 0$  for smallpox (per Table 5-84) and  $I_1(7) = 0$ , Equation 5-20 reduces to:

$$I_1(8) = \frac{E_2(7) \cdot \left(1 - \rho_E(d_{\text{p-on}}) \cdot v_{\text{on}}(7)\right)}{\mu_{E2}} = \frac{568 \cdot (1 - 0.02 \cdot 0)}{4.6} = 123.48 \quad 5-20$$

7. Skipping to Day 12, the last day before vaccination affects the cohort populations: the cohort populations for Day 11 are the first step to calculating the Day 12 cohort populations: S(11) = 231.29, E<sub>1</sub>(11) = 16.23, E<sub>2</sub>(11) = 213.55, I<sub>1</sub>(11) = 189.14, I<sub>2</sub>(11) = 155.86, R<sub>DOW</sub>(11) = 2.98, R<sub>S</sub>(11) = 6.95, R<sub>RTD</sub>(11) = 0, and P(11) = 0.. For brevity, the equations shown below will contain the actual numbers, rather than first showing the symbols and then showing the numbers. For the symbols, refer back to the original statement of the equations in Section 5.1.5.

a. Beginning with Equation 5-13, first calculate  $S(12)$ :

$$S(12) = 231.29 \cdot (1 - 0.95 \cdot 0) \cdot \left( 1 - \frac{0.752619 \cdot (0 \cdot 189.14 + (1-0) \cdot 155.86)}{816} \right) + 0 \cdot 0 = 198.04 \quad 5-13$$

b. Next, use Equation 5-18 to calculate  $E_1(12)$ :

$$E_1(12) = 16.23 \cdot (1 - 0.02 \cdot 0) \cdot \left( 1 - \frac{1}{7} \right) + \frac{231.29 \cdot (1 - 0.95 \cdot 0) \cdot 0.752619 \cdot (0 \cdot 189.14 + (1-0) \cdot 155.86)}{816} = 47.16 \quad 5-18$$

c. Next, use Equation 5-19 to calculate  $E_2(12)$ :

$$E_2(12) = 213.55 \cdot (1 - 0.02 \cdot 0) \cdot \left( 1 - \frac{1}{4.6} \right) + \frac{16.23 \cdot (1 - 0.02 \cdot 0)}{7} = 169.45 \quad 5-19$$

d. Next, use Equation 5-20 to calculate  $I_1(12)$ :

$$I_1(12) = \left( 189.14 \cdot \left( 1 - \frac{1}{3} \right) + \frac{213.55 \cdot (1 - 0.02 \cdot 0)}{4.6} \right) \cdot (1 - 0 \cdot 0 \cdot 1) = 172.52 \quad 5-20$$

e. Next, use Equation 5-21 to calculate  $I_2(12)$ :

$$I_2(12) = 155.86 \cdot \left( 1 - \frac{1}{14} \right) + \frac{189.14}{3} = 207.77 \quad 5-21$$

f. Next, use Equation 5-22 to calculate  $R_{DOW}(12)$ . Note that  $p_f(d-1) = 0.3$ , since it has been zero days since vaccination (per Table 5-86).

$$R_{DOW}(12) = 2.98 + \frac{155.68}{14} \cdot 0.3 = 6.32 \quad 5-22$$

g. Next, use Equation 5-23 to calculate  $R_S(12)$ .

$$R_S(12) = 6.95 + \frac{155.86}{14} \cdot (1 - 0.3) - \frac{0}{14} \cdot (1 - 0.3) + (0 \cdot 0 \cdot 1) \cdot \left( 189.14 \cdot \left( 1 - \frac{1}{3} \right) + \frac{213.55 \cdot (1 - 0.02 \cdot 0)}{4.6} \right) - (0 \cdot 0 \cdot 1) \cdot \left( 0 \cdot \left( 1 - \frac{1}{3} \right) + \frac{0 \cdot (1 - 0.02 \cdot 0)}{4.6} \right) = 14.74 \quad 5-23$$

h. Finally, use Equation 5-24 to calculate  $R_{RTD}(12)$  (not shown; value is 0).

8. To finish the example, the calculations for Day 13 are shown below.



$$S(13) = 198.04 \cdot (1 - 0.95 \cdot 1) \cdot \left( 1 - \frac{1.138454 \cdot (0 \cdot 172.52 + (1-0) \cdot 207.77)}{816} \right) + 0 \cdot 0 = 7.03 \quad 5-13$$

$$E_1(13) = 47.16 \cdot (1 - 0.02 \cdot 1) \cdot \left( 1 - \frac{1}{7} \right) + \frac{198.04 \cdot (1 - 0.95 \cdot 1) \cdot 1.138454 \cdot (0 \cdot 172.52 + (1-0) \cdot 207.77)}{816} = 42.49 \quad 5-18$$

$$E_2(13) = 169.45 \cdot (1 - 0.02 \cdot 1) \cdot \left( 1 - \frac{1}{4.6} \right) + \frac{47.16 \cdot (1 - 0.02 \cdot 1)}{7} = 136.56 \quad 5-19$$

$$I_1(13) = \left( 172.52 \cdot \left( 1 - \frac{1}{3} \right) + \frac{169.45 \cdot (1 - 0.02 \cdot 1)}{4.6} \right) \cdot (1 - 0 \cdot 0 \cdot 1) = 151.11 \quad 5-20$$

$$I_2(13) = 207.77 \cdot \left( 1 - \frac{1}{14} \right) + \frac{172.52}{3} = 250.44 \quad 5-21$$

$$R_{DOW}(13) = 6.32 + \frac{207.77}{14} \cdot 0.3 = 10.77 \quad 5-22$$

$$R_S(13) = 14.74 + \frac{207.77}{14} \cdot (1 - 0.3) - \frac{0}{14} \cdot (1 - 0.3) + (0 \cdot 0 \cdot 1) \cdot \left( 172.52 \cdot \left( 1 - \frac{1}{3} \right) + \frac{169.45 \cdot (1 - 0.02 \cdot 1)}{4.6} \right) - (0 \cdot 0 \cdot 1) \cdot \left( 0 \cdot \left( 1 - \frac{1}{3} \right) + \frac{0 \cdot (1 - 0.02 \cdot 0)}{4.6} \right) = 25.13 \quad 5-23$$

9. After the calculations are repeated for all days of interest, the REPORT section can be completed. The final day of interest is the day that  $\beta(d)$  goes to zero and stays there, plus  $\mu_{E1} + \mu_{E2} + \mu_1 + \mu_2 + \mu_{RS}$ .

#### A.8.6. REPORT–Contagious Model

1. Following Table 5-3, it is straightforward to calculate the values to be used to populate the output tables. Examples are not given here because the equations are either simpler than or very similar to those demonstrated in Section A.8.5. Note that the casualty criterion in this example is WIA(3<sup>+</sup>), so individuals do not become casualties when in Stage 1 of illness—only in Stage 2. The final results are shown in Table A-34 and Table A-35.

2. By comparing the DOW rows in the two tables, one can see that some problems related to rounding have appeared. Rather than prescribe a method of accounting for rounding error in the methodology, the user may use any desired method of dealing with rounding errors.

**INTENTIONALLY BLANK**

**Table A-34: Estimated Daily Number of New Smallpox Casualties\***

Casualty Description	Day ≤8	Day 9	Day 10	Day 11	Day 12	Day 13	Day 14	Days 15-21	Days 22-28	Days 29-35	Days 36-42	Days 43-49	Days 50-56	Days 57-63	Days 64-70	Days 71-77	Days 78-99	Days ≥100
New DOW (B)	0	0	1	2	3	4	5	6	6-4	4-2	2-1	1-0	0	0	0	0	0	0
New WIA (Smallpox)	0	41	60	65	63	58	50	43-16	14-5	4-2	1	0	0	0	0	0	0	0
New CONV (Smallpox)	0	0	2	5	8	10	13	14-17	17-14	13-10	9-7	6-4	4-3	2	1	1	1-0	0
New RTD	0	0	0	0	0	0	0	2-16	16	16-13	12-9	8-6	5-4	3-2	2-1	1	1-0	0

\* Estimate is based on Casualty Criterion WIA(3+), a PAR of 816, and  $d_{vac-spox} = 12$  days.

**Table A-35: Estimated Personnel Status for Smallpox Casualties\***

Casualty Description	Day ≤8	Day 9	Day 10	Day 11	Day 12	Day 13	Day 14	Days 15-21	Days 22-28	Days 29-35	Days 36-42	Days 43-49	Days 50-56	Days 57-63	Days 64-70	Days 71-77	Days 78-99	Days ≥100
Fatalities																		
DOW (B)	0	0	1	3	6	11	16	61	67-97	100-117	118-126	127-130	130-132	132-133	133	133	133-134	134
WIA																		
Smallpox (3)	0	29	69	109	145	191	226	252-282	275-214	203-142	133-89	83-54	51-33	31-20	18-12	11-7	7-0	0
Smallpox (4)	0	12	29	47	62	60	57	54-38	36-24	23-15	14-9	8-5	5-3	3-2	2-1	1	1-0	0
Sum of WIA	0	41	98	156	208	250	283	306-320	311-238	226-157	147-98	91-59	56-36	34-22	20-13	12-8	8-0	0
CONV																		
CONV (Smallpox)	0	0	2	7	15	25	38	50-85	85-75	72-55	52-37	35-24	22-15	14-9	9-6	5-3	3-0	0
RTD																		
RTD	0	0	0	0	0	0	0	2-67	84-186	202-286	299-359	368-409	414-440	443-460	462-472	473-479	480-489	489

\* Estimate is based on Casualty Criterion WIA(3+), a PAR of 816, and  $d_{vac-spox} = 12$  days.

**INTENTIONALLY BLANK**

<b>ANNEX B      REFERENCES</b>
--------------------------------

- Baba, Anthony J., Brian R. Schallhorn, Steward Share, and Susan M. Gaspar. *Incidence of Skin Burns under Contemporary Army Uniforms Exposed to Thermal Radiation from Simulated Nuclear Fireballs*. HDL-TR-2084. Adelphi, MD: U.S. Army Laboratory Command, Harry Diamond Laboratories, December 1986.
- Barss, Neil M., and Ronald L. Weitz. "Reconstruction of External Dose for Beta Radiation Sources of Nuclear Weapon Origin." *Health Physics* 91, no. 4 (2006): 379–389.
- Blewett, William K., Dennis W. Reeves, Victor J. Arca, David P. Fatkin, and Brenda P. Cannon. *Expedient Sheltering in Place: An Evaluation for the Chemical Stockpile Emergency Preparedness Program*. Aberdeen Proving Ground, MD: Edgewood Research Development and Engineering Center, June 1996.
- Cerveney, T. J., T. J. MacVittie, and R. W. Young. "Acute Radiation Syndrome in Humans." In *Warfare, Weaponry, and the Casualty*, Edited by Richard I. Walker and T. J. Cerveney, 15–36. *Textbooks of Military Medicine*. Falls Church, VA: Office of the Surgeon General, Department of the Army, 1996.
- Defense Threat Reduction Agency (DTRA). *Standard Method ED04– Skin Dose from Dermal Contamination*. Fort Belvoir, VA: DTRA, 31 January 2010.
- Dolatshahi, F., D. C. Kaul, and W. A. Woolson. *Technical and User's Manual, Fortran Edition, Version 6 of Air Transport of Radiation (ATR6)*. SAIC-90/1507, DNA-TR-91-165. La Jolla, CA: Science Applications International Corporation, 1992.
- Drake, M. K., M. P. Fricke, D. E. Groce, D. C. Kaul, C. J. Ridfleisch, J. B. Swenson, and W. A. Woolson. *An Interim Report on Collateral Damage*. DNA 4734Z. La Jolla, CA: Science Applications, Inc., October 1978. CB009013.
- "Hazard Prediction and Assessment Capability." Version 5.3.226 with Patch 3. Defense Threat Reduction Agency, 2015.
- Eckerman, Keith F., and Jeffrey C. Ryman. *External Exposure to Radionuclides in Air, Water, and Soil*. Federal Guidance Report No. 12, EPA-402-R-93-081. Washington, DC: U.S. Environmental Protection Agency, September 1993.
- International Atomic Energy Agency (IAEA). *Dangerous Quantities of Radioactive Material*. Vienna: IAEA, August 2006.
- . *Generic Procedures for Assessment and Response During a Radiological Emergency*. IAEA-TECDOC-1162. Vienna: IAEA, 2000.

- Johnson, Ted. *A Guide to Selected Algorithms, Distributions, and Databases Used in Exposure Models Developed by the Office of Air Quality Planning and Standards*. Chapel Hill, NC: TRJ Environmental, Inc., 2002.
- Layton, David W. "Metabolically Consistent Breathing Rates for Use in Dose Assessments." *Health Physics* 64, no. 1 (1993): 23–36.
- Levin, Sheldon G. *The Effect of Combined Injuries from a Nuclear Detonation on Soldier Performance*. Espanola, NM: Technical Southwest, Inc., 1993.
- McClellan, Gene E., George H. Anno, and Leigh N. Matheson. *Consequence Analytic Tools for NBC Operations Volume 3: Chemical Agent Exposure and Casualty Estimation*. Alexandria, VA: Defense Special Weapons Agency, 1998.
- McClellan, Gene E., David J. Crary, and Darren R. Oldson. *Approximating the Probability of Mortality Due to Protracted Radiation Exposures*. DTRA-TR-16-054. Fort Belvoir, VA: Defense Threat Reduction Agency, June 2016.
- North Atlantic Treaty Organization (NATO). *AAP-6: NATO Glossary of Terms and Definitions*, STANAG 3680. Brussels, Belgium: NATO, April 2014.
- . *AEP-4: Nuclear Survivability Criteria for Armed Forces Material and Installations*. STANAG 4145. Brussels, Belgium: NATO, September 1996. NATO CONFIDENTIAL.
- . *AJMedP-1: Allied Joint Medical Planning Doctrine*, STANAG 2542. Brussels, Belgium: NATO, November 2009.
- . *AJMedP-7: Allied Joint Medical Doctrine for Support to CBRN Defensive Operations*, STANAG 2596. Brussels, Belgium: NATO, August 2015.
- . *AJP-3.8(A): Allied Joint Doctrine for CBRN Defence*, STANAG 2451. Brussels, Belgium: NATO, March 2012.
- . *AJP-4(A): Allied Joint Logistics Doctrine*, STANAG 2182. Brussels, Belgium: NATO, March 2004.
- . *AJP-4.10(B): Allied Joint Medical Support Doctrine*, STANAG 2228. Brussels, Belgium: NATO, May 2015.
- . *AJP-5: Allied Joint Doctrine for Operational-Level Planning*, STANAG 2526. Brussels, Belgium: NATO, June 2013.
- . *AMedP-7.6: Commander's Guide on Medical Support to Chemical, Biological, Radiological, and Nuclear (CBRN) Defensive Operations*, STANAG 2873. Brussels, Belgium: NATO, study.
- . *AMedP-13(A): NATO Glossary of Medical Terms and Definitions*, STANAG

2409. Brussels, Belgium: NATO, 6 May 2011.

———. *ATP-45(E): Warning and Reporting and Hazard Prediction of Chemical, Biological, Radiological and Nuclear Incidents (Operators Manual)*, STANAG 2103. Brussels, Belgium: NATO, January 2014. NATO UNCLASSIFIED.

Northrop, John A., ed. *Handbook of Nuclear Weapon Effects: Calculational Tools Abstracted from DTRA's Effects Manual One (EM-1)*. Ft. Belvoir, VA: Defense Threat Reduction Agency, 2002.

Park, J. H., J. D. Spengler, D. W. Yoon, T. Dumyahn, K. Lee, and H. Ozkaynak. "Measurement of Air Exchange Rate of Stationary Vehicles and Estimation of in-Vehicle Exposure." *Journal of Exposure Analysis and Environmental Epidemiology* 8, no. 1 (1998): 65–78.

U.S. Army Chemical School (USACMLS). *Potential Military Chemical/Biological Agents and Compounds*. FM 3-11.9/MCRP 3-37.1B/NTRP 3–11.32/AFTTP(I) 3-2.55. Washington, DC: U.S. Government Printing Office, January 2005.

U.S. Department of the Army. *The Effects of Nuclear Weapons*. Army Pamphlet 50-3. Washington, DC: U.S. Department of the Army, March 1977.

U.S. Department of the Army. *Personnel Risk and Casualty Criteria for Nuclear Weapons Effects*. Army Pamphlet 50-7. Washington, DC: U.S. Department of the Army, 1 October 2013..

**INTENTIONALLY BLANK**



<b>LIST OF ACRONYMS AND ABBREVIATIONS</b>
---

<b>AAP</b>	Allied Administration Publication
<b>AC</b>	Hydrogen cyanide
<b>ACH</b>	Air changes per hour
<b>AJP</b>	Allied Joint Publication
<b>AMedP</b>	Allied Medical Publication
<b>APF</b>	Aggregate Protection Factor
<b>BDO</b>	Battle dress overgarment
<b>BDU</b>	Battle dress uniform
<b>CAT</b>	Casualty category
<b>CBRN</b>	Chemical, biological, radiological, and nuclear
<b>CFU</b>	Colony forming unit
<b>CG</b>	Phosgene
<b>CK</b>	Cyanogen chloride
<b>Cl<sub>2</sub></b>	Chlorine
<b>ColPro</b>	Collective protection
<b>CONV</b>	Convalescent
<b>CRN</b>	Chemical, radiological, and nuclear
<b>Ct</b>	Concentration time
<b>cut</b>	Cutaneous
<b>DOW</b>	Died of wounds
<b>EC<sub>t50</sub></b>	Effective median dosage (concentration time)
<b>ED<sub>50</sub></b>	Median effective dose
<b>EEEV</b>	Eastern equine encephalitis virus
<b>EVD</b>	Ebola virus disease
<b>FIA</b>	Free-in-air
<b>GA</b>	Tabun
<b>GB</b>	Sarin
<b>G-CSF</b>	Granulocyte-colony stimulating factor
<b>GD</b>	Soman
<b>GF</b>	Cyclosarin
<b>Gy</b>	Gray
<b>H<sub>2</sub>S</b>	Hydrogen sulfide
<b>HD</b>	Distilled sulfur mustard
<b>HPAC</b>	Hazard Prediction and Assessment Capability
<b>hr</b>	Hour

<b>ID<sub>50</sub></b>	Median infectious dose; dose resulting in infection and illness for 50% of the exposed population
<b>IPE</b>	Individual protective equipment
<b>J/cm<sup>2</sup></b>	Joule per square centimeter
<b>KIA</b>	Killed in action
<b>kg</b>	Kilogram
<b>kJ/m<sup>2</sup></b>	Kilojoule per square meter
<b>kPa</b>	Kilopascal
<b>LD<sub>50</sub></b>	Median lethal dose; dose resulting in lethality for 50% of the exposed population
<b>m</b>	Meter
<b>mg</b>	Milligram
<b>min</b>	Minute
<b>MTF</b>	Medical treatment facility
<b>N/A</b>	Not applicable
<b>NATO</b>	North Atlantic Treaty Organization
<b>NBC</b>	Nuclear, biological, and chemical
<b>NH<sub>3</sub></b>	Ammonia
<b>N.O.I.</b>	No observable injury
<b>PAR</b>	Population at risk
<b>PDT</b>	Probability density table
<b>%BSA</b>	Percentage body surface area burned to second or third degree level
<b>PFU</b>	Plaque forming units
<b>RBE</b>	Relative biological effectiveness
<b>RDD</b>	Radiological dispersal device
<b>RTD</b>	Return to Duty
<b>S/S</b>	Signs and symptoms
<b>SEB</b>	Staphylococcal enterotoxin B
<b>SEIRP</b>	Susceptible, Exposed and infected, Infectious, Removed, and Prophylaxis efficacious
<b>STANAG</b>	NATO standardization agreement
<b>TBq</b>	Terabecquerel (10 <sup>12</sup> becquerels)
<b>TRM</b>	Technical Reference Manual
<b>VEEV</b>	Venezuelan equine encephalitis virus

<b>VX</b>	O-Ethyl-S-(2-diisopropylaminoethyl) methyl phosphonothiolate
<b>WB</b>	Whole-body
<b>WEEV</b>	Western equine encephalitis virus
<b>WIA</b>	Wounded in action
<b>WIA(1+)</b>	Wounded in action (Severity Level 1 (“Mild”) or greater)
<b>WIA(2+)</b>	Wounded in action (Severity Level 2 (“Moderate”) or greater)
<b>WIA(3+)</b>	Wounded in action (Severity Level 3 (“Severe”) or greater)

**AMedP-7.5(A)(1)**